

TM 9-787A

WAR DEPARTMENT

TECHNICAL MANUAL

HEAVY TRACTOR M1
(ALLIS-CHALMERS HD-10W)

DECEMBER 21, 1942

HEAVY TRACTOR M1

(ALLIS-CHALMERS HD-10W)

Prepared under the direction of the
Chief of Ordnance

(with the cooperation of the Allis-Chalmers Manufacturing Company)

CONTENTS

PART ONE—Operating Instructions

| SECTION | | Paragraphs | Pages |
|---------|---|------------|--------|
| I. | Introduction | 1- 3 | 4- 7 |
| II. | Description and tabulated data | 4- 5 | 8- 16 |
| III. | Operating instructions and controls | 6- 26 | 17- 31 |
| IV. | Lubrication | 27- 32 | 32- 41 |
| V. | Preventive maintenance | 33- 42 | 42- 48 |
| VI. | General care and preservation | 43- 44 | 49 |
| VII. | Painting | 45- 50 | 50- 52 |
| VIII. | Materiel affected by gas | 51- 54 | 53- 55 |

PART TWO—Organization Instructions

| | | | |
|-------|---|---------|---------|
| IX. | General information on maintenance | 55 | 56- 58 |
| X. | Standard tools and equipment | 56- 57 | 59- 61 |
| XI. | Engine | 58- 64 | 62- 90 |
| XII. | Fuel and air system | 65- 73 | 91-123 |
| XIII. | Cooling system | 74- 80 | 124-138 |
| XIV. | Lubrication system | 81- 84 | 139-146 |
| XV. | Electrical system and equipment | 85- 96 | 147-180 |
| XVI. | Nonelectrical instruments | 97-101 | 181-186 |
| XVII. | Electric and air trailer brake control system | 102-104 | 187-197 |

0 930878
HEAVY TRACTOR M1
UNIVERSITY OF U. S.

| | Paragraphs | Pages |
|---|------------|---------|
| SECTION XVIII. Master clutch and clutch brake | 105-109 | 198-203 |
| XIX. Steering clutches | 110-113 | 204-208 |
| XX. Tractor brakes | 114-115 | 209-211 |
| XXI. Final drives | 116-118 | 212-214 |
| XXII. Tracks and truck frame assembly | 119-123 | 215-225 |
| XXIII. Winch and power take-off . . . | 124-125 | 226-229 |
| XXIV. Storage and shipment | 126-132 | 230-241 |
| XXV. Cold weather lubrication and service | 133-138 | 242-246 |
| XXVI. References | 139-140 | 247-248 |
| INDEX | | 249-257 |

HEAVY TRACTOR M1

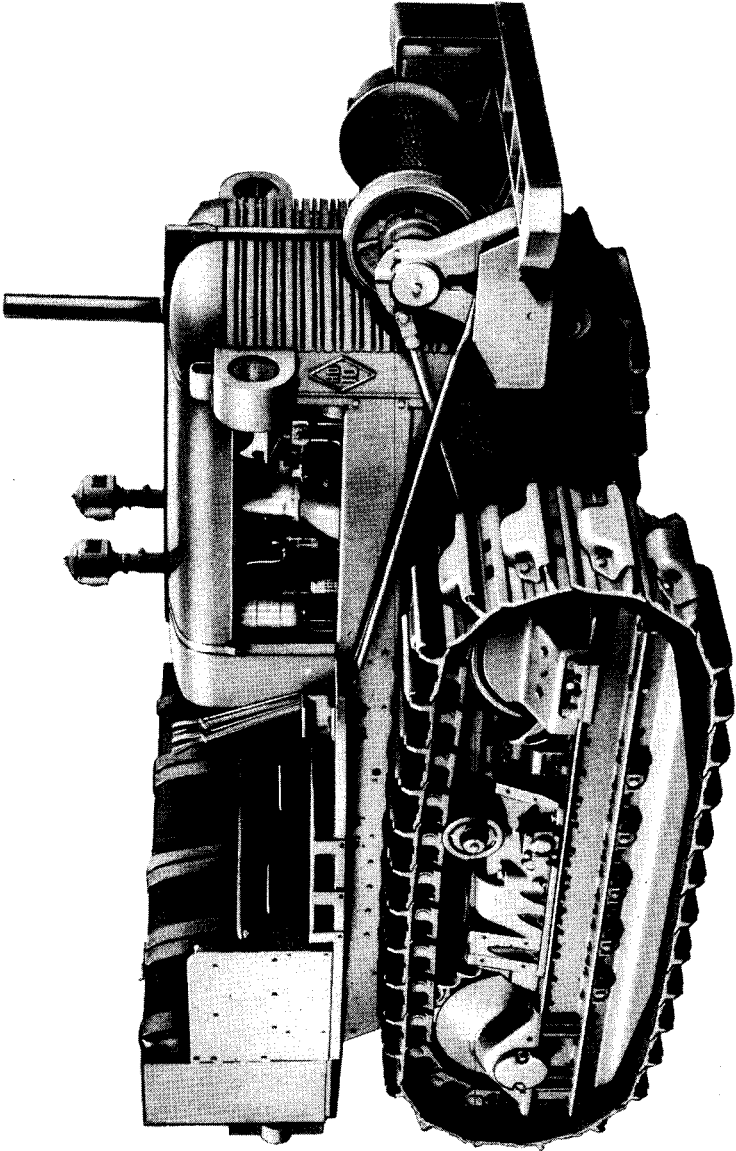

RA PD 17201

Heavy Tractor M1 — Frontispiece

HEAVY TRACTOR M1

PART ONE—Operating Instructions

Section I

INTRODUCTION

| | Paragraph |
|---|-----------|
| Purpose and scope | 1 |
| Content and arrangement of manual | 2 |
| References | 3 |

1. PURPOSE AND SCOPE.

a. The information and instructions contained in this manual provide a guide for all personnel charged with the operation, lubrication, and light maintenance of this materiel. Specifications, illustrations, and detailed instructions are given regarding the operation, lubrication, adjustments, and minor repairs. Group assemblies and component parts are listed under separate headings, with detailed instructions under each heading explaining the proper operation or adjustments necessary to keep or put the machine in normal operating condition.

2. CONTENT AND ARRANGEMENT OF MANUAL.

a. Part One consists of specifications and photographs of the tractor, lubrication charts and specifications, and general operating instructions. Part Two consists of illustrations and instructions on adjustments and minor repairs.

3. REFERENCES.

a. A list of references will be found in section XXVI of this manual.

INTRODUCTION

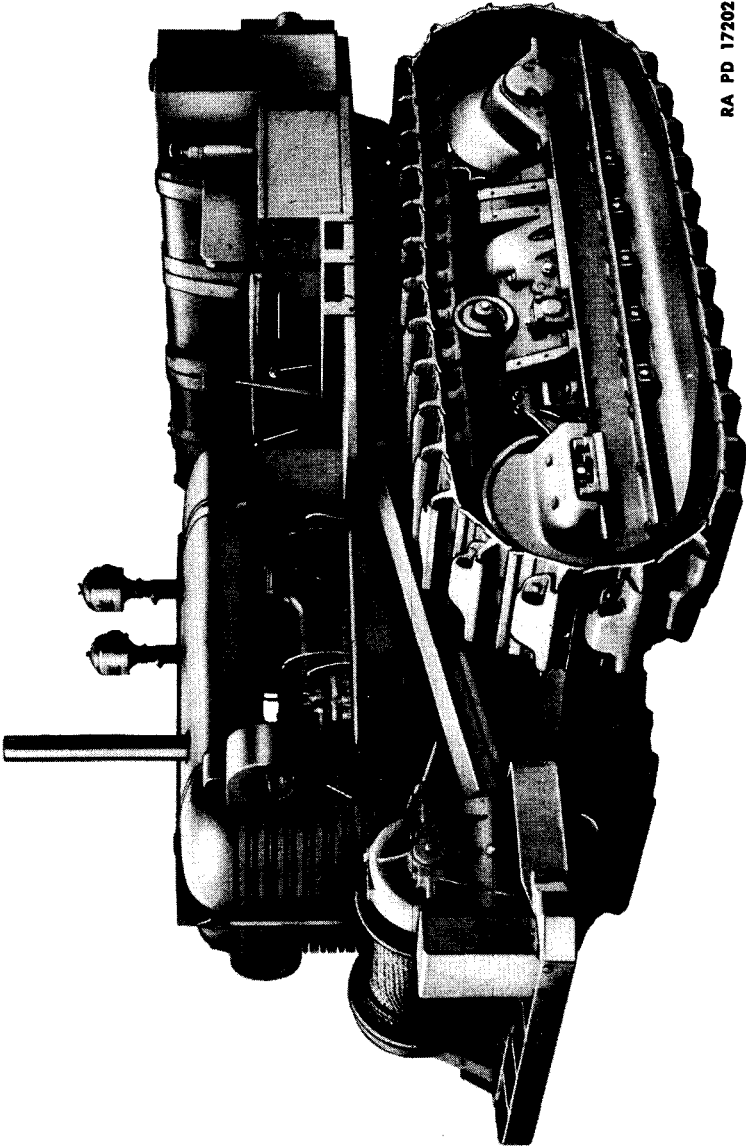

RA PD 17202

Figure 1 — Heavy Tractor M1 — Three-quarter Left Front View

HEAVY TRACTOR M1

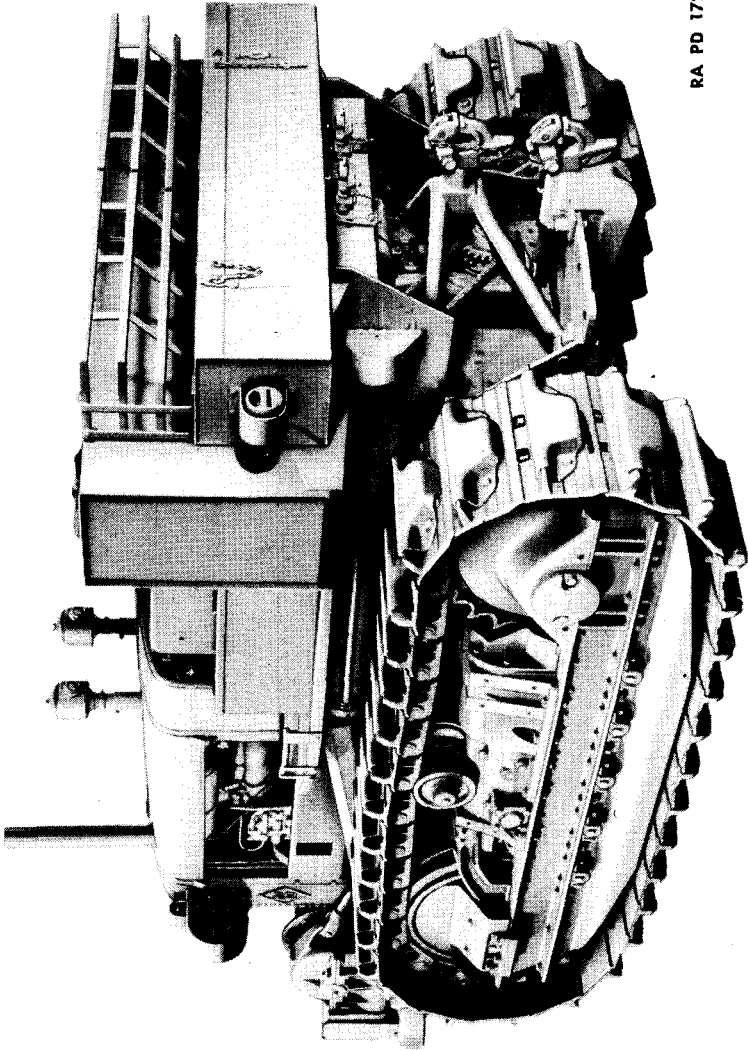

RA PD 17203

Figure 2—Heavy Tractor M1—Three-quarter Left Rear View

INTRODUCTION

RA PD 17204

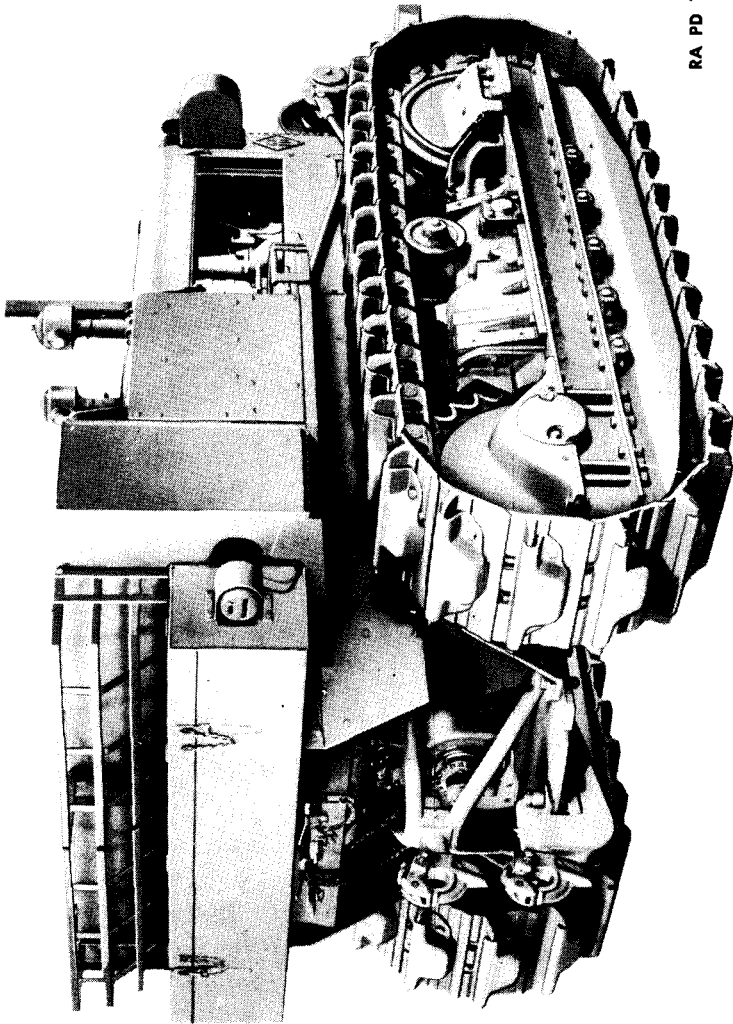

Figure 3—Heavy Tractor M1—Three-quarter Right Rear View

HEAVY TRACTOR M1

Section II

DESCRIPTION AND TABULATED DATA

| | Paragraph |
|----------------------|-----------|
| Description | 4 |
| Tabulated data | 5 |

4. DESCRIPTION.

a. **General.** This tractor is of the crawler or track-laying type and may be used for either highway or cross country travel. Because of its relatively low center of gravity, the tractor can climb slopes as steep as 30 degrees, depending on the kind of footing available and the load being pulled.

b. **Engine.** Power is supplied by a water-cooled, 4-cylinder, valve-in-head, 2-cycle Diesel engine. A multiple speed transmission is used offering six forward speeds ranging from 1.87 miles per hour to 11.00 miles per hour and two reverse speeds of 2.05 miles per hour and 4.60 miles per hour at full throttle engine speed. The fuel tank has a capacity of 156 gallons which permits about 20 hours of operation without refueling.

c. **Steering.** Steering is accomplished by means of steering clutches operated by two levers, mounted in the center of the tractor within easy reach of the operator. Each lever controls a multiple disk steering clutch through which power is delivered from the transmission to the final drive sprockets.

d. **Seat.** The seat has removable cushions and safety straps and will accommodate the operator and three other men.

e. **Winch.** The winch is mounted on the front of the tractor and is driven by a reversible power take-off from the tractor transmission. A control lever for the power take-off is just ahead of the seat and in easy reach of the operator.

f. **Equipment.** Equipment on the tractor includes batteries, electric starter, generator, lights, mile meter, engine air heater and engine pre-heater for cold weather starting, fire extinguisher, electric and air trailer brake control system, snatch block, tow chain, and loose tools.

g. **Tractor and Engine Numbers.** The serial number of the tractor is stamped on the steering clutch lever stop which is on the gear shifter housing and also on the rear of the transmission case on the right side just below the top. The engine number can be found on a bronze plate on the right side of the engine in back of the governor.

DESCRIPTION AND TABULATED DATA

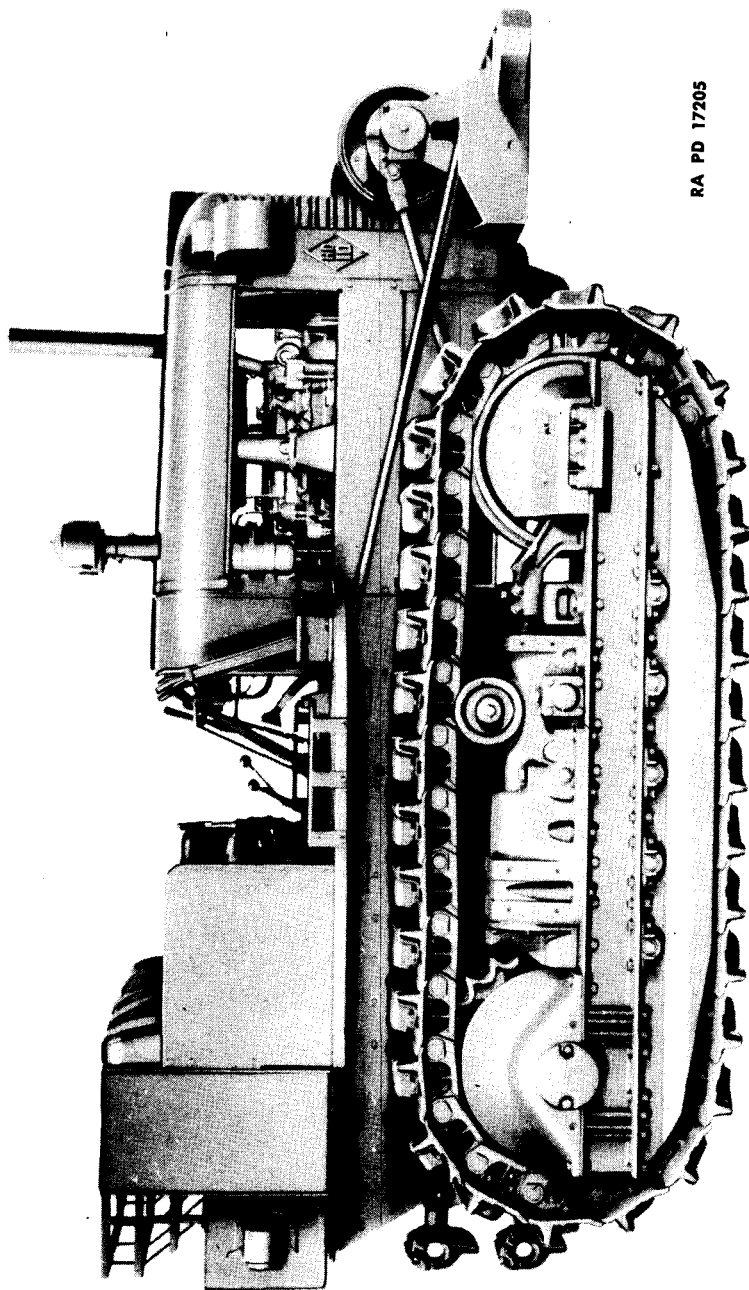

RA PD 17205

Figure 4—Heavy Tractor M1—Right Side View

HEAVY TRACTOR M1

RA PD 17206

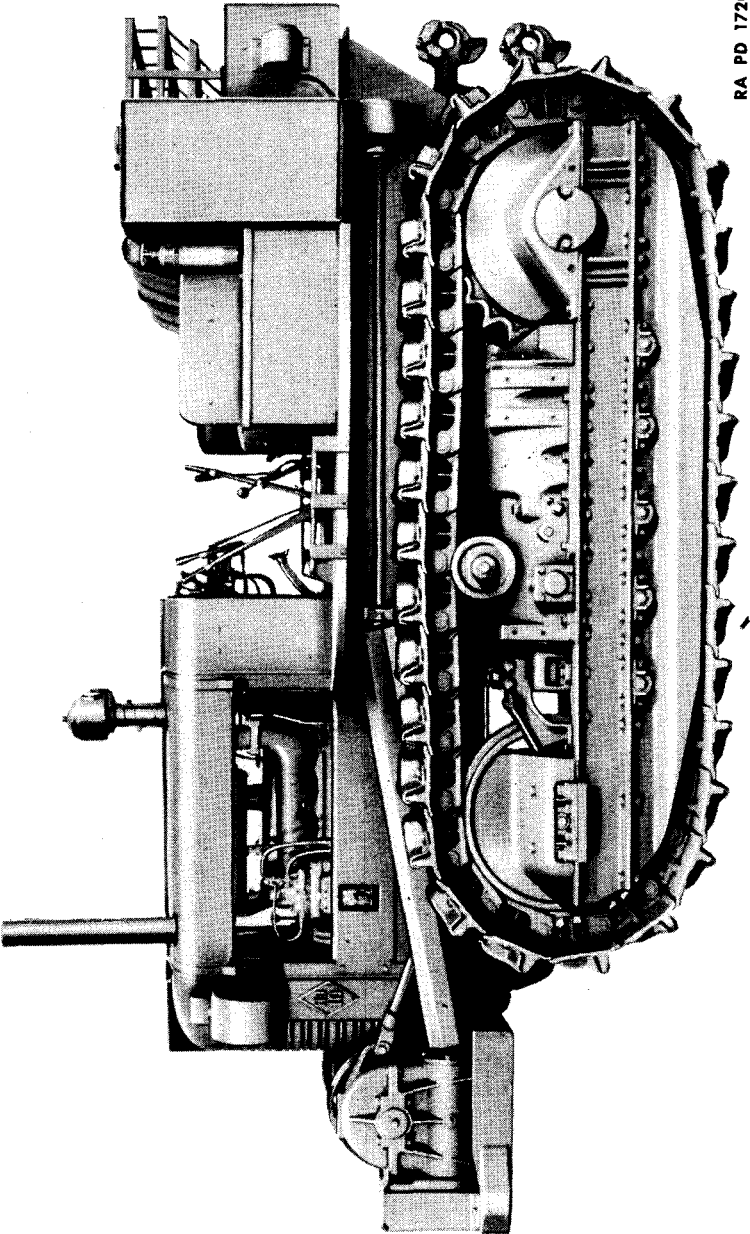
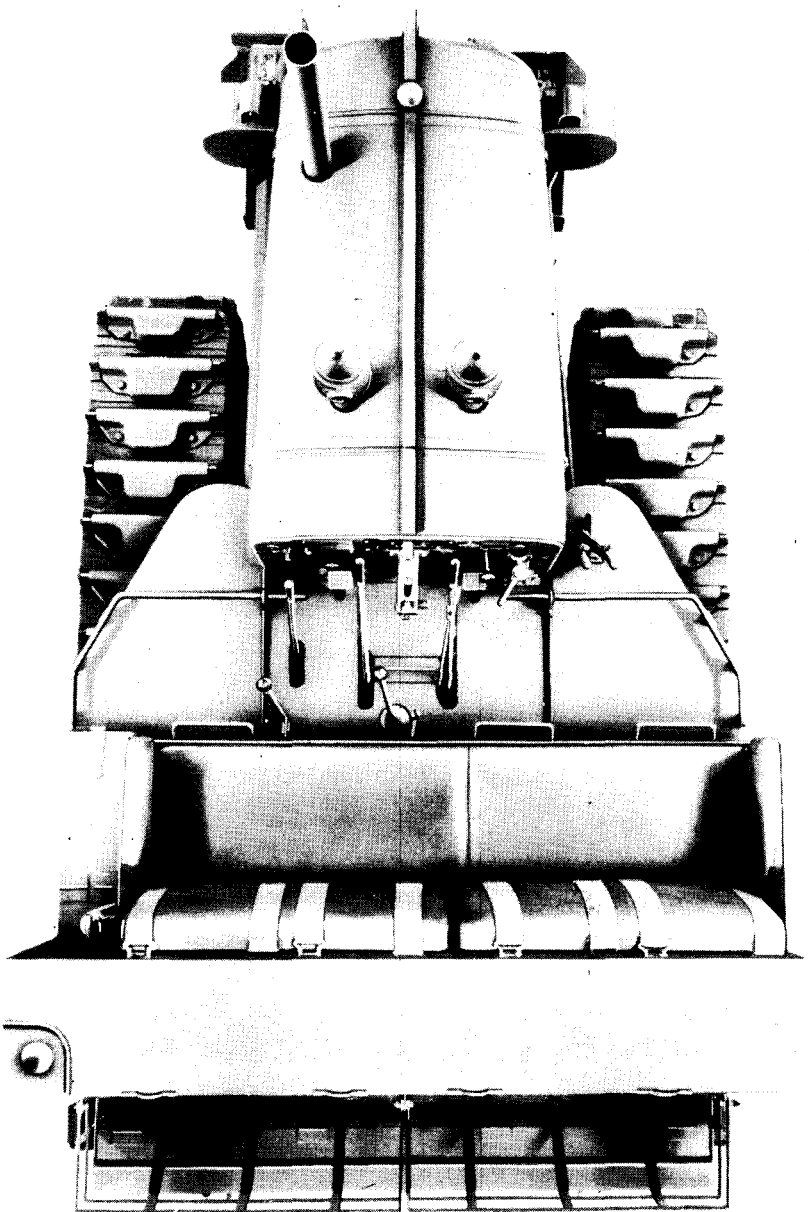

Figure 5—Heavy Tractor M1—Left Side View

DESCRIPTION AND TABULATED DATA



RA PD 17207

Figure 6—Heavy Tractor MI—Top View

HEAVY TRACTOR M1

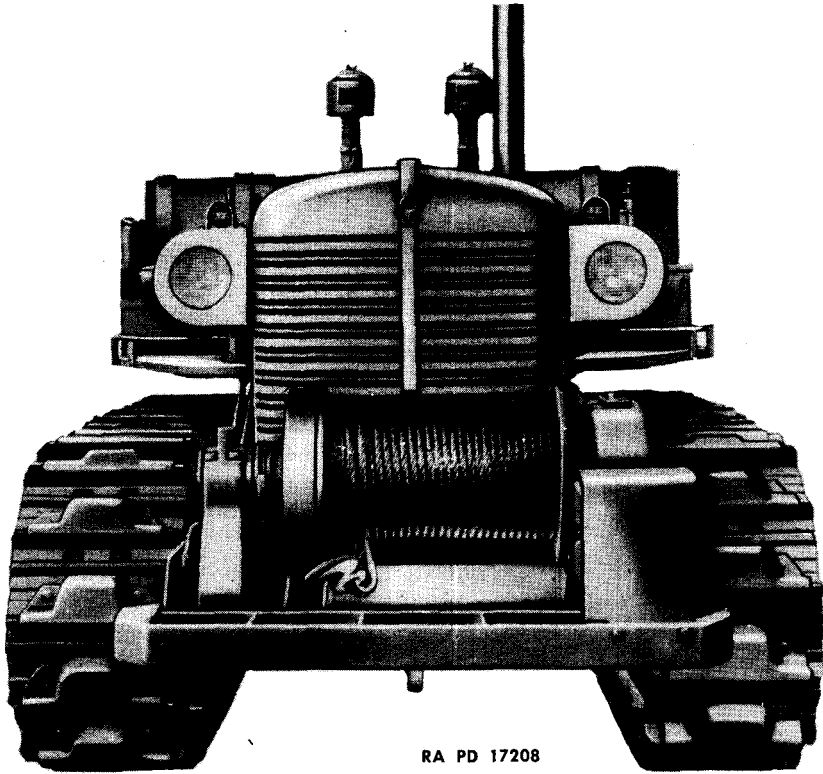

RA PD 17208

Figure 7—Heavy Tractor M1—Front View

5. TABULATED DATA.

a. General.

Maximum drawbar horsepower:

| | |
|--|------|
| At 2,000 rpm (full throttle)..... | 88.5 |
| At 1,750 rpm (throttle in stop notch)..... | 84.2 |

Maximum drawbar pull:

| | |
|--|-----------|
| At 2,000 rpm (full throttle)..... | 18,350 lb |
| At 1,750 rpm (throttle in stop notch)..... | 20,120 lb |
| Shipping weight (approx.)..... | 25,500 lb |

b. Dimensions.

| | |
|---|--------------|
| Over-all length | 14 ft 5½ in. |
| Over-all width | 8 ft 1 in. |
| Over-all height | 8 ft 4 in. |
| Tread width (center to center of tracks)..... | 6 ft 2 in. |

DESCRIPTION AND TABULATED DATA

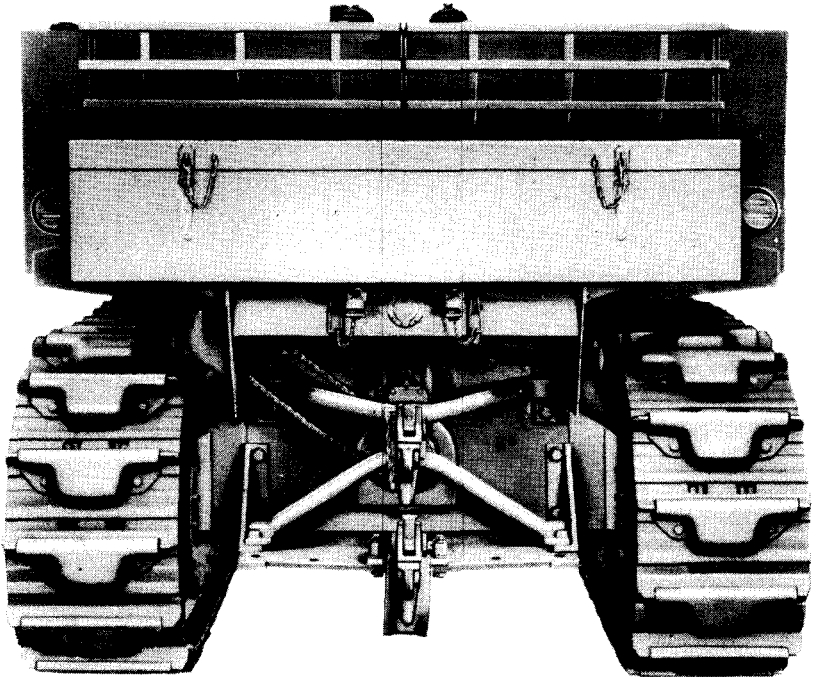

RA PD 17209

Figure 8—Heavy Tractor M1—Rear View

| | |
|-----------------------------------|------------------------------------|
| Ground clearance | 12 in. |
| Height of lower pintle | 21 ⁵ / ₈ in. |
| Height of upper pintle | 34 ¹ / ₄ in. |
| Lateral movement of drawbar | 32 in. |
| Turning radius | 10 ft 10 in. |

c. Performance.

Speeds and drawbar pull:

At 2,000 rpm (full throttle)

| | |
|------------------------------|-----------|
| First gear (1.87 mph) | 18,350 lb |
| Second gear (2.98 mph) | 10,950 lb |
| Third gear (4.21 mph) | 7,160 lb |
| Fourth gear (4.88 mph) | 5,860 lb |
| Fifth gear (6.72 mph) | 3,560 lb |
| Sixth gear (11.00 mph) | 1,120 lb |
| Low reverse gear (2.05 mph) | |
| High reverse gear (4.60 mph) | |

HEAVY TRACTOR M1

At 1,750 rpm (throttle in stop notch)

| | |
|------------------------------|-----------|
| First gear (1.63 mph) | 20,120 lb |
| Second gear (2.60 mph) | 12,170 lb |
| Third gear (3.68 mph) | 8,080 lb |
| Fourth gear (4.27 mph) | 6,680 lb |
| Fifth gear (5.88 mph) | 4,230 lb |
| Sixth gear (9.62 mph) | 1,590 lb |
| Low reverse (1.80 mph) | |
| High reverse (4.02 mph) | |

Maximum trench crossing (estimated) 3 ft

Maximum fording depth (at minimum speed):

Without drain plugs in master clutch and steering clutch compartments 21 in.

With drain plugs in master clutch and steering clutch compartments 41¼ in.

Maximum grade ascending ability (estimated) 30 deg

Maximum grade descending ability (estimated) 30 deg

Allowable list (side slope) (estimated) 30 deg

Maximum vertical obstacle 22½ in.

d. Engine (General Motors 4-71 RC14).

| | |
|--|----------------|
| Number of cylinders | 4 |
| Firing order | 1-3-4-2 |
| Bore and stroke | 4¼ in. x 5 in. |
| Piston displacement | 284 cu in. |
| Rated speed (at full throttle) | 2,000 rpm |
| Rated speed (throttle in stop notch) | 1,750 rpm |
| Revolutions per minute (at maximum torque) | 800-1,200 |

e. Steering.

| | |
|---|---------------|
| Method | Clutches |
| Number of friction surfaces (each clutch) | 30 |
| Total area of friction surfaces (each clutch) | 1516.5 sq in. |

f. Tracks.

| | |
|---|--------------------|
| Length of track on ground | 6 ft 5¾ in. |
| Ground contact area (each track) | 1,542 sq in. |
| Width of shoes | 20 in. |
| Grouser height | 2 in. |
| Number of track shoe bolts (per shoe) | 4 |
| Diameter of track shoe bolts | 2⅓ in. |
| Diameter of track pins | 1¾ in. |
| Diameter of track pin bushings | 2½ in. |
| Number of shoes per track | 32 |
| Ground pressure (approx.) | 8.27 lb per sq in. |
| Type of bearings in truck wheels and idlers | Tapered roller |

DESCRIPTION AND TABULATED DATA

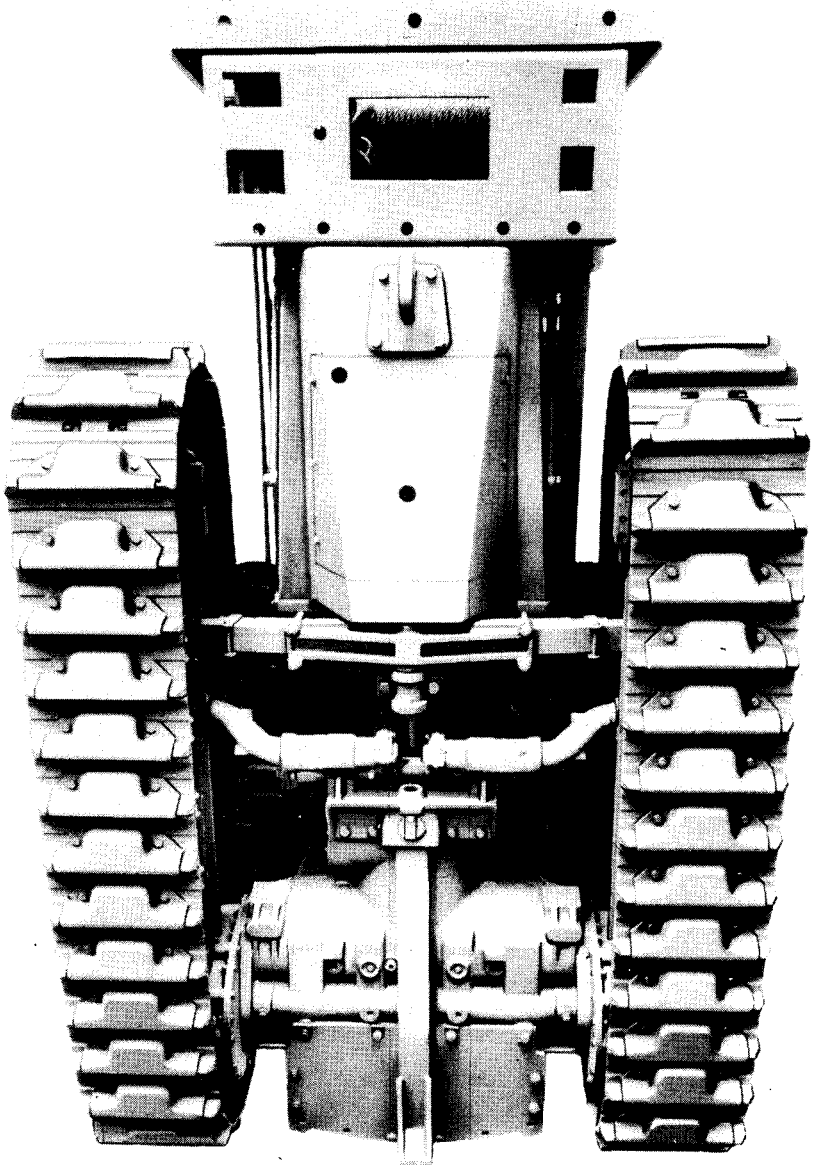

RA PD 17210

Figure 9—Heavy Tractor M1—Bottom View

HEAVY TRACTOR M1

g. Winch.

| | |
|---------------------------------|------------------------------------|
| Length of drum | 22 ³ / ₄ in. |
| Diameter of drum | 7 in. |
| Length of cable | 300 ft |
| Diameter of cable | ³ / ₄ in. |
| Maximum cable speed (bare drum) | 33 ft per min |
| Maximum pull | 30,000 lb |

h. Power Take-Off.

| | |
|---------------------------------|-----|
| Rpm at rated engine speed (max) | 540 |
|---------------------------------|-----|

i. Capacities.

| | |
|------------------------------|-----------------------------------|
| Fuel tank | 156 gal |
| Engine crankcase | 3 ¹ / ₄ gal |
| Air compressor crankcase | ³ / ₄ qt. |
| Cooling system | 9 ³ / ₄ gal |
| Transmission case | 6 gal |
| Final drive case | 2 gal |
| Track release spring housing | 1 ⁷ / ₈ gal |
| Winch gear housing | 1 gal |
| Power take-off housing | 2 ¹ / ₈ gal |

Section III

OPERATING INSTRUCTIONS AND CONTROLS

| | Paragraph |
|--|-----------|
| Inspection of new tractor | 6 |
| Prepare new tractor for use | 7 |
| Prepare new batteries for use | 8 |
| Operation of new tractor | 9 |
| Engine starting instructions (temperature normal) | 10 |
| Engine starting instructions (temperature 40 F to 0 F) | 11 |
| Engine starting instructions (temperature below 0 F) | 12 |
| Stop engine | 13 |
| Use of master clutch | 14 |
| Transmission | 15 |
| Steering | 16 |
| Steering clutch brakes | 17 |
| Steering down hill | 18 |
| Operating in abnormal conditions | 19 |
| Use of winch and controls | 20 |
| Power take-off | 21 |
| Use of trailer brakes | 22 |
| Parking vehicles | 23 |
| Lighting system | 24 |
| Hour meter | 25 |
| Mile meter | 26 |

6. INSPECTION OF NEW TRACTOR.

a. Make a complete inspection for any shortage or damage which may have occurred while in transit or in storage.

7. PREPARE NEW TRACTOR FOR USE.

a. Remove the air cleaner oil bath cups to make sure they contain the correct amount and grade of oil (par. 73).

b. Inspect the oil level in the engine crankcase, air compressor crankcase, transmission case, final drive gear cases, track release spring housings, winch gear housing, and the power take-off housing.

c. Lubricate all other parts of the tractor in accordance with instructions in section IV. The truck wheels, track support rollers, and front idlers must be filled by means of a special flushing lubricator supplied with the tractor. These rollers have been filled with oil at the factory, but before tractor is put into operation they should be thoroughly flushed and refilled to remove any metal particles which might remain from manufacturing operation and have loosened during shipment.

NOTE: All lubrication points are painted red.

HEAVY TRACTOR M1

d. Check and fill fuel tank with the correct fuel oil. Special care must be taken to prevent the entrance of dirt or foreign materials while filling the tank.

e. Fill the cooling system with clean water. **CAUTION:** Remove the pipe plug (fig. 28) in the thermostat housing while filling cooling system. This allows the air to pass out of motor block while water is put in. Replace the plug when water runs out of the hole and finish filling. In winter weather, use a standard antifreeze solution in the cooling system. The solution should be tested daily and kept to the proper strength for the prevailing temperatures. The antifreeze used should have a higher boiling point than the engine operating temperature (160 F to 180 F).

8. PREPARE NEW BATTERIES FOR USE.

a. The batteries shipped with the tractor contain dry charged plates but no electrolyte. Vent plugs are screwed in tight and must remain so until the cells are filled with electrolyte. Keep vent plugs and sealing disks tight until ready to prepare battery for service; then discard disks.

(1) Remove sealing disks, located on top or under vent plugs, and make certain vent holes in all plugs are open.

(2) Fill cells to $\frac{3}{8}$ inch above separators with electrolyte not warmer than 70 F. (Electrolyte is furnished with tractor.)

(3) Let battery stand one hour; then, if liquid level has fallen, add electrolyte to restore level. Screw vent plugs in place. Wipe off any spillage.

(4) Charge battery 16 to 20 hours at 14 amperes before placing in service. Use series charging (never constant potential) for this initial charging.

9. OPERATION OF NEW TRACTOR.

a. Operate a new tractor with a light load during the first 60 hours. After the first 10 hours of operation, the tractor should be stopped and inspected for loose bolts and nuts. The steering clutch and the master clutch adjustments should be checked (pars. 108 and 112).

10. ENGINE STARTING INSTRUCTIONS (Temperature Normal).

a. Figure 10 shows the operating controls and instruments.

b. Each time before starting engine, the operator should make a prestarting inspection (par. 34). Then proceed as follows:

(1) Close radiator shutter by pulling on shutter control lever.

(2) Push engine shut-off control forward.

(3) Open throttle lever to stop notch.

CAUTION: See that master clutch and power take-off are disengaged and gear shift lever is in neutral position.

OPERATING INSTRUCTIONS AND CONTROLS

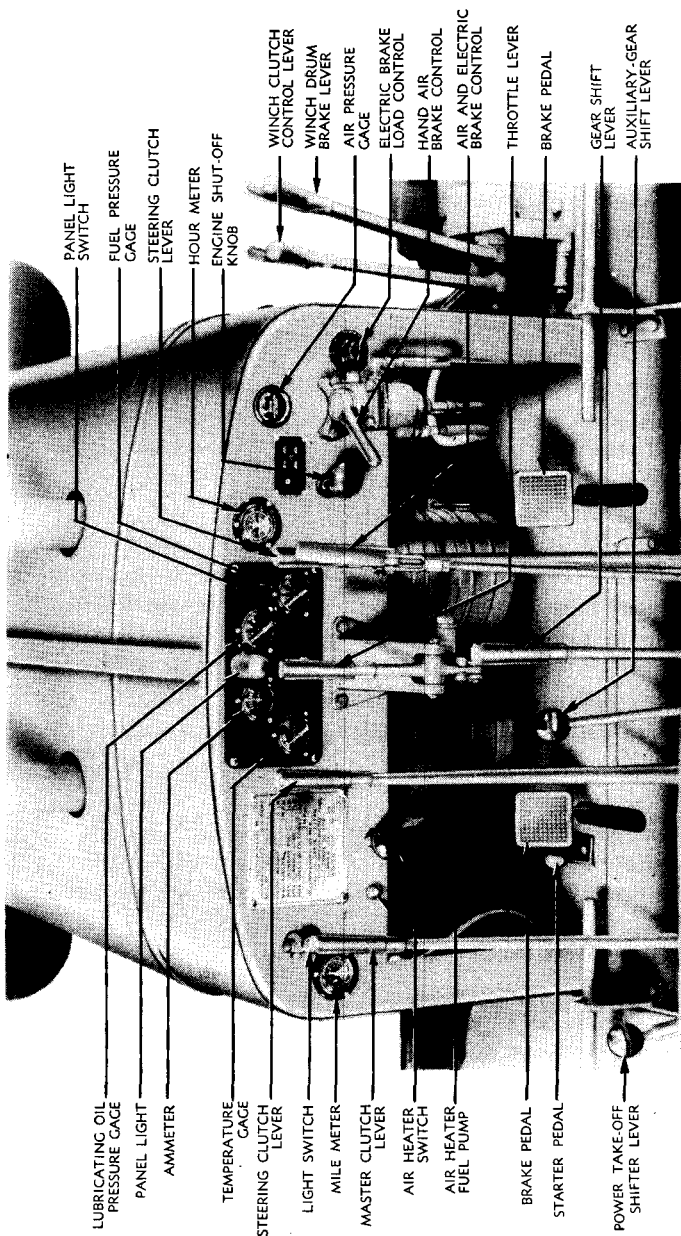

RA PD 53975

Figure 10—Operator's Controls

HEAVY TRACTOR M1

(4) Push starter pedal. As soon as engine fires and begins to run, close throttle to about three-quarter engine speed and allow engine to warm up. When engine temperature reaches 160 F, open radiator shutter; shutter should be adjusted so that an operating temperature of 160 F to 180 F is maintained at all times.

(5) Check lubricating oil pressure. Oil pressure should be between 25 and 35 on the gage with engine running at full governed speed and heated to normal operating temperature. Pressure may drop to five on the gage when engine is idling. If the oil is cold, no pressure may register for about 15 seconds after the engine starts. If the pressure does not rise to between 25 and 35 under normal operating conditions, the engine should be stopped and the cause determined.

(6) Check fuel oil pressure. Fuel pressure at full governed engine speed should be from 20 to 30 on the gage. Operate throttle to meet various operating conditions.

11. ENGINE STARTING INSTRUCTIONS (TEMPERATURE 40 F to 0 F).

a. Engine can be started in temperatures of zero or a little below by using the air heater, if engine and batteries are in good condition and lubricating oil used is of the proper viscosity.

b. Operation of Air Heater.

(1) Close radiator shutter by pulley and shutter control.

(2) Push engine shut-off knob to its "IN" position and open throttle lever to stop notch.

(3) Release air heater fuel pump plunger by turning one-quarter to one-half turn counterclockwise.

(4) Close air heater switch by pressing on the button at left side of dash, engage starter, and operate pump with smooth even strokes. **NOTE:** These three operations must be performed simultaneously. By doing this, practically all fuel pumped through the air heater will be burned, reducing collection of raw fuel in the air box to a minimum. If the starter is not used with the air heater, oxygen in the engine will soon be exhausted; then the flame will go out and raw fuel will be pumped into the engine. The air heater should be operated for a short period after engine starts; to keep the engine operating smoothly.

(5) Check lubricating oil pressure (par. 10).

(6) Check fuel oil pressure. Fuel pressure at full governed engine speed should be from 20 to 30 on the gage. Operate throttle to meet various operating conditions.

OPERATING INSTRUCTIONS AND CONTROLS

12. ENGINE STARTING INSTRUCTIONS (TEMPERATURE BELOW 0 F).

a. In temperatures below zero, it may be necessary to use the engine preheater (figs. 11, 12, and 13).

b. Install preheater intake assembly on engine in place of one of the air box inspection covers, if this has not been done previously. This intake elbow is divided into two parts by a baffle. The heater extension tube will fit into upper part. The lower opening is for exhaust of heater gases after circulation through the air box.

c. Operation of Engine Preheater.

(1) Remove filler plug and fill case about two-thirds full of fuel oil, the same as is used in the fuel tank of the tractor.

(2) Replace filler plug securely to prevent leakage.

(3) Close needle valve.

(4) Pump up to about 120 pounds pressure with hand pump.

(5) Close air regulator plate next to preheater fan.

(6) Plug preheater fan wire into the socket on front of cowl which is directly connected to the battery. The heater fan should start immediately and run as long as the connection is maintained.

(7) Separate heater from extension tube; then open needle valve until a good spray or mist is ejected. Ignite spray with a match or other means; then place heater on extension tube.

(8) Loosen wing nuts on the top of intake elbow and open cover. Place end of preheater extension tube into intake elbow. Open air regulator plate. Preheater will blow hot gases into engine air box and will circulate them around all cylinders. For the proper length of time to leave preheater on, refer to the following chart:

| Atmospheric Temperature | Preheater On |
|-------------------------|------------------|
| 0 F..... | 10 to 15 minutes |
| — 10 F..... | 10 to 15 minutes |
| — 20 F..... | 10 to 20 minutes |
| — 30 F..... | 15 to 20 minutes |
| — 40 F..... | 15 to 30 minutes |

(9) After preheater has been in operation for the proper length of time, remove it; close needle valve and air regulator plate; remove plug from socket; close cover on intake elbow and fasten it securely. Start the engine immediately, using the engine air heater, as when starting in mild cold weather conditions. **CAUTION:** Do not attempt to start the engine until the engine preheater has been removed and the intake cover has been securely replaced.

HEAVY TRACTOR M1

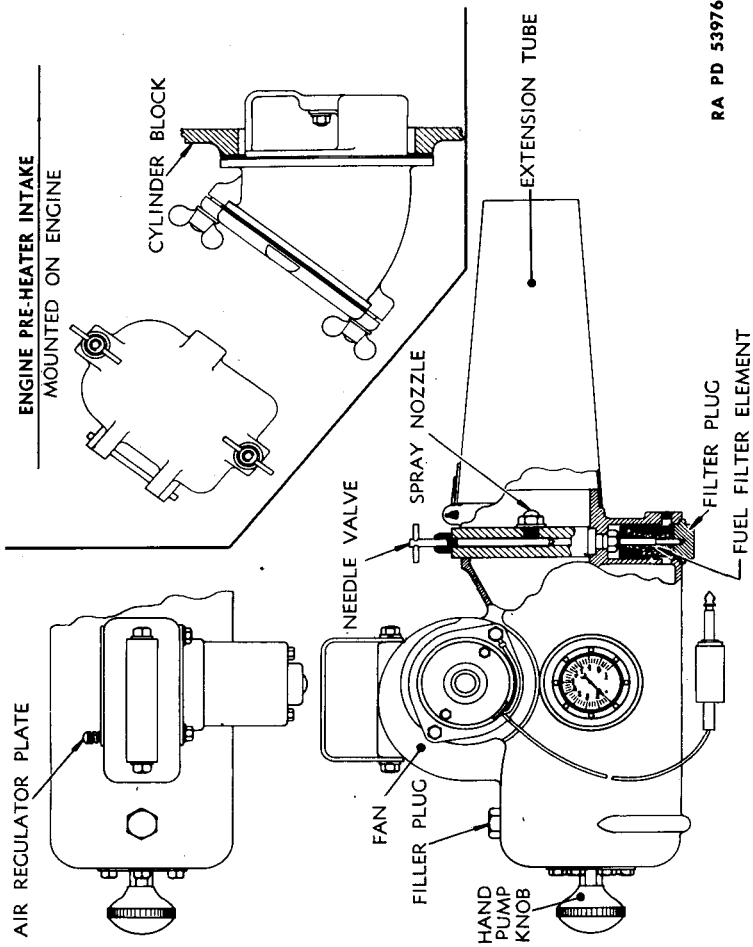
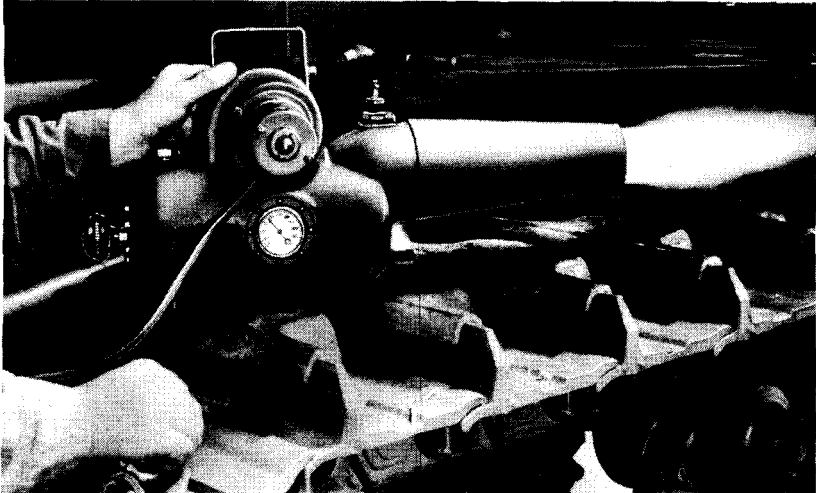

Figure 11 — Engine Preheater

OPERATING INSTRUCTIONS AND CONTROLS



RA PD 17701

Figure 12—Engine Preheater

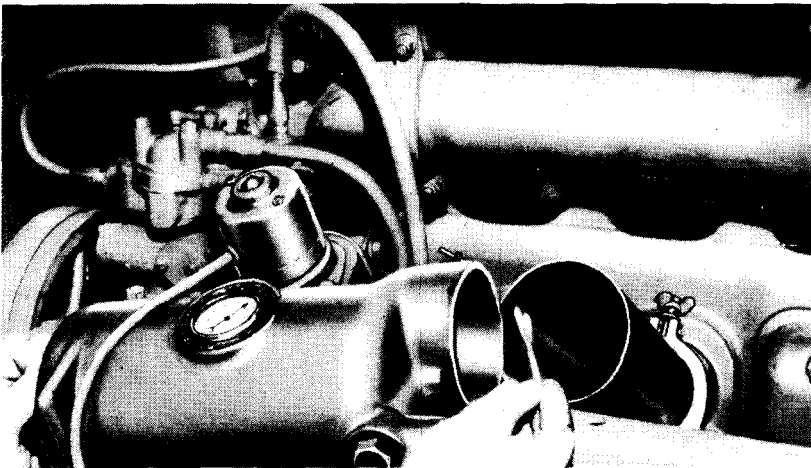

RA PD 17662

Figure 13—Igniting Preheater Spray

d. The engine preheater is used to warm up engine for easy cranking only and will not aid combustion by furnishing warm air to the cylinders. For this reason, it is necessary to use the engine air heater, as this unit heats the cold air before it is drawn into the combustion chamber.

e. Place preheater back in box on tractor.

HEAVY TRACTOR M1

13. STOP ENGINE.

a. Close the throttle lever and pull engine shut-off knob all the way out.

14. USE OF MASTER CLUTCH.

a. When the correct gears are engaged, open the throttle and pull back steadily on master clutch lever until all slack is taken up between tractor and load; then, pull lever back quickly to full extent to lock clutch in its engaged position.

b. Do not slip the master clutch in an effort to pull an overload at high speeds. Avoid excessive wear on the clutch disk facings by shifting to a lower speed when necessary. Do not let engine idle with master clutch disengaged. When engine is idling, shift gears into neutral and engage master clutch.

15. TRANSMISSION.

a. **Description.** The transmission has six forward and two reverse speeds. The high and low range make possible this variety of speeds.

b. **Care.** The transmission requires little attention other than maintaining proper oil level. Lubrication instructions are covered in section IV. The transmission case should be washed with OIL, engine, SAE 10, at the time the oil is changed. Fill to the proper level with OIL, engine, SAE 10. Operate the tractor in low gear first for a few minutes. Drain and lubricate.

c. **Use of Gear Shift Levers** (figs. 14 and 15). Two levers are used to shift the gears. The left lever (looking forward) is an auxiliary lever for shifting the auxiliary gears and has two positions, indirect (forward) and direct (backward). The right lever is the gear shift lever and has four positions. When the auxiliary gear shift lever is in the direct (back) position the tractor can be run in third, fifth, sixth, and high reverse; when in indirect (forward) position the tractor can be run in first, second, fourth, and low reverse.

d. The following chart shows the position of the two gear shift levers to obtain any of the six forward and two reverse speeds:

| Gear | Gear Shift Lever | Auxiliary Shift Lever |
|--------------|-------------------|-----------------------|
| First | Left and back | Forward (indirect) |
| Second | Right and forward | Forward (indirect) |
| Third | Left and back | Back (direct) |
| Fourth | Left and forward | Forward (indirect) |
| Fifth | Right and forward | Back (direct) |
| Sixth | Left and forward | Back (direct) |
| Low reverse | Right and back | Forward (indirect) |
| High reverse | Right and back | Back (direct) |

Once a speed has been selected and the tractor is in operation, further gear shifting cannot be done until the clutch has been disengaged and the tractor stopped.

OPERATING INSTRUCTIONS AND CONTROLS

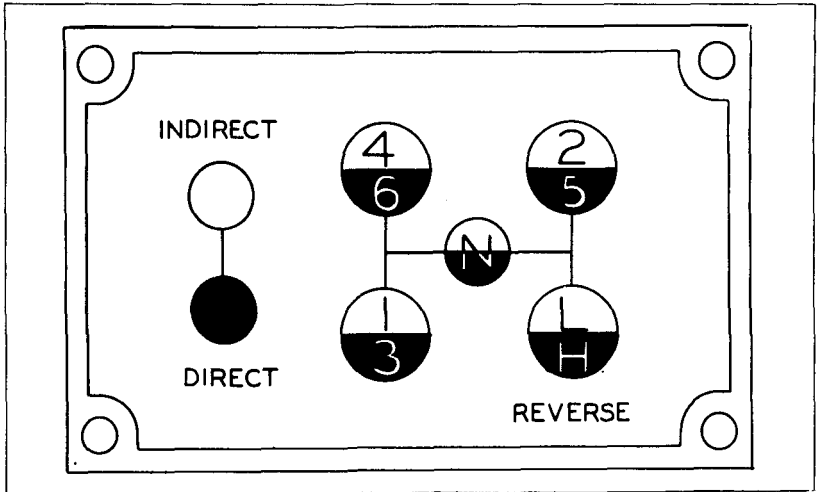

RA PD 17213

Figure 14—Gear Shift Instruction Plate

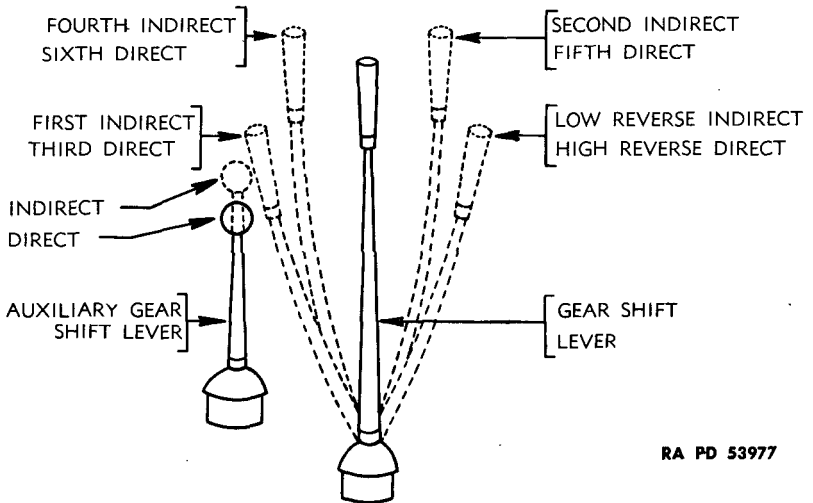

RA PD 53977

Figure 15—Gear Shift Lever Positions

e. To shift gears, push master clutch lever forward and shift gears to the desired speed. When the master clutch lever is pushed forward, it forces the release bearing carrier against the clutch brake assembly fastened to the clutch shaft, thus bringing the transmission gears to a rapid stop. This quick stopping of the gears enables the operator to shift without clashing the gears.

HEAVY TRACTOR M1

16. STEERING.

a. Steering the tractor is accomplished by the use of steering clutches which are operated by steering levers to disconnect power from either track. Turn the tractor in the desired direction by pulling back to the full extent the steering lever on the side toward which the turn is to be made. This disengages the clutch on that side and should be done quickly and evenly to avoid excessive clutch wear. **CAUTION:** Do not release the levers and let them fly forward. Do not operate tractor with steering clutches partially disengaged. Avoid excessive wear of the steering clutches by releasing and engaging the steering clutches smoothly and completely.

17. STEERING CLUTCH BRAKES.

a. The steering clutch brakes are for retarding the speed or holding the track on the inside of the turn stationary when the steering clutch on that side is released for making the turn. Always release the steering clutch before depressing the brake when making a turn. The steering brakes are also used as service brakes for retarding the speed of the tractor when going down grade and to hold the tractor stationary.

18. STEERING DOWN HILL.

a. In steering the tractor down steep grades with the load pushing the tractor, the use of the steering clutches is opposite to that of a tractor pulling a load. If it is desired to make a turn toward the right, the left steering clutch should be released. The engine, being connected to the right track, acts as a brake retarding its progress, while the left track is released and free to travel faster.

b. If a shorter turn is desired when the load is pushing the tractor, apply the brake on the side opposite the side on which the clutch is released.

19. OPERATING IN ABNORMAL CONDITIONS.

a. The master clutch and steering clutch compartments are dry compartments and are provided with drain holes to drain out any oil that might leak into the compartments by overlubrication or other causes (fig. 9). In normal operation, these holes are to be left open. When operating in mud, water, or extreme dusty or sandy conditions the plugs provided with the tractor should be installed in these drain holes to prevent the entrance of dirt or water. The plugs should be removed daily to allow any oil or grease that might accumulate in the compartments to drain out, preventing it from getting on the brake bands or clutch facings. If the tractor is idle at night, the plugs may be removed to drain the compartments, then replaced in the morning. Inspect the final drives frequently and drain, wash, and refill the case as often as the lubricant shows the presence of any mud or water.

OPERATING INSTRUCTIONS AND CONTROLS

20. USE OF WINCH AND CONTROLS.

a. **To Engage the Winch.** Before operating the winch, the engine must be idling and the tractor stopped, with the engine clutch disengaged. Then, pull the power take-off shifter lever back until the lock on the lever engages in the front notch (unwinding position for unreeling cable from drum). Release the winch brake, engage the master clutch, and the cable will unreel from the drum. Unreel just enough cable so that the hook can be attached to the load and disengage the master clutch.

b. **To pull load after cable is attached,** push power take-off shifter lever ahead until lock catches in rear notch (winding position). Set the foot brakes by pushing the brake pedals down hard and lock them by lifting up on brake pedal lever locks. Engage master clutch and cable will wind up and pull load. **NOTE:** Winch can be operated in either of two speeds by shifting the tractor auxiliary gear shift lever. Direct position gives the highest winch speed. In indirect position, the winch runs at 44 percent of the speed when in direct position and gives a corresponding increase in winch pull. Use caution in engaging load to prevent cable breakage or excessive strain on winch. Always try to keep cable wound evenly and smoothly on the drum. Stop winch by disengaging master clutch. If load is to be moved a little at a time, cable will be held taut when master clutch is disengaged by the automatic safety brake on the winch worm shaft. If cable is tight when pull is completed, move tractor ahead to relieve strain so cable may be released. Wind cable up, release jaw clutch and pull power take-off shifter lever into neutral position (lock in middle notch). Set winch hand brake by pushing inside lever on fender forward. **CAUTION:** Never pull out winch jaw clutch when winch is under load.

c. The winch hand brake is used only to control the drum when reeling off cable by hand or if another machine is pulling on the cable to unreel it. **CAUTION:** Be sure jaw clutch is disengaged if cable is unreeled in this way.

21. POWER TAKE-OFF.

a. Bearings on the upper power take-off shaft are splash-lubricated, and if the tractor is used with the power take-off disengaged, these bearings will receive no lubrication. Therefore, while the tractor is running, the power take-off should be engaged once a day and run a few minutes in order to lubricate these bearings. **CAUTION:** Make sure that this is done to prevent these bearings from running dry and freezing.

22. USE OF TRAILER BRAKES.

a. Brakes on a trailer pulled by the tractor may be operated either by air or by electricity (depending on the type of brakes mounted on

HEAVY TRACTOR M1

the trailing unit) since the tractor is equipped with complete controls and operating mechanism for both air brakes and electric brakes. Trailer brakes operate only on the load behind the tractor and are not effective in stopping the tractor itself.

b. The trailer brakes have two controls. The hand grip on the right steering clutch lever (fig. 10), when compressed, operates either the air or the electric brakes, while the hand control on the right of dash is used for operating the air brakes only. Only one system is used at a time, depending on whether drawn vehicle is equipped with air or electric brakes.

c. **Connections.**

(1) Two air hose couplings are provided for connecting trailer air brake hoses. The one on the left is marked "SERVICE" and the one on the right "EMERGENCY." The corresponding hoses on the trailer should be connected to these couplings. When tractor is operating without trailer, valves should be closed and the dummy couplings hanging on tractor should be installed to keep dirt and dust out of system.

(2) The rear coupling socket on the tractor is wired so that when the plug from a trailer vehicle equipped with electric brakes is inserted, all electric brake and light apparatus will operate properly from tractor light switches and brake controls.

d. **Operation of Electric Brakes.** The brakes should be operated according to the requirements of the trailer. If a light braking effect is desired, the electric brake load control at the right of dash may be set accordingly. Turning knob to left (counterclockwise) gives a lighter braking effect, and turning knob to right increases braking power. The brake can be applied only by squeezing grip on right steering clutch lever. Trailer stop light goes on automatically.

e. **Operation of Air Brakes.** The air brakes can be applied either by squeezing the steering lever grip or by moving hand air brake control at right of dash to the right. Use air brakes lightly by moving air brake control lever clear to right and back halfway quickly. Repeat this action until stop is made. This causes brake shoes to be applied repeatedly against brake drums without locking and sliding wheels. When it is necessary to stop the vehicle as quickly as possible, the operator can lock the wheels by holding the lever all the way to the right until the stop is made. The steering lever grip is operated in the same manner if this brake control is used.

f. The master clutch of the tractor should be disengaged and tractor brakes applied whenever trailer brakes are used. Care should be taken that trailer and tractor brakes are applied evenly and at the same time to prevent jackknifing of the tractor and trailer unit.

OPERATING INSTRUCTIONS AND CONTROLS

23. PARKING VEHICLES.

a. If tractor and trailer are to be parked, especially on a slope where there is a possibility of rolling, the tractor foot brakes should be set by depressing pedals as far down as possible and lifting brake pedal lever locks to lock them in position.

24. LIGHTING SYSTEM.

a. The lighting control system on the tractor is designed to operate both the lights on the trailed vehicle and those on the tractor. Proper connections are located at the rear of the tractor.

b. **Light Switches.** The light switch at left of dash has three positions for turning on the various lights. When the knob is pulled out to the first stop, only the blackout lights are turned on. For regular service lights, the small button on the top of the switch must be pressed down and knob pulled out to the second stop. To use the stop light only, for day driving, press top button and pull knob full out. This light goes on automatically when the master clutch lever is pushed forward to disengage clutch.

c. The panel light is turned on by pulling out knob marked "PANEL LIGHT." This will not function unless other lights have been turned on also.

d. Turn off all lights by pushing knobs all the way in.

25. HOUR METER (fig. 16).

a. **Description.** This meter is electrically operated. A small automatic pressure switch is closed by oil pressure as soon as the engine is started and the oil pressure reaches five pounds. The small hand at the top left of the dial will then start rotating. This hand indicates that the meter is operating.

b. How to Read Hour Meter.

(1) The three hands in the center of the dial record the number of hours the tractor has operated and are of three different lengths. Total hours is determined by reading the number each hand has passed, the same as we look at a clock to see which number the hour hand, the minute hand, and the second hand have passed, and thereby tell the time.

(2) The shortest hand requires 1,000 hours of operation for it to pass each numeral, or 10,000 for a complete revolution. It stands between 2 and 3 which indicates over 2,000 hours of operation (fig. 16). This indicates that the first numeral in the number of hours operated

HEAVY TRACTOR M1

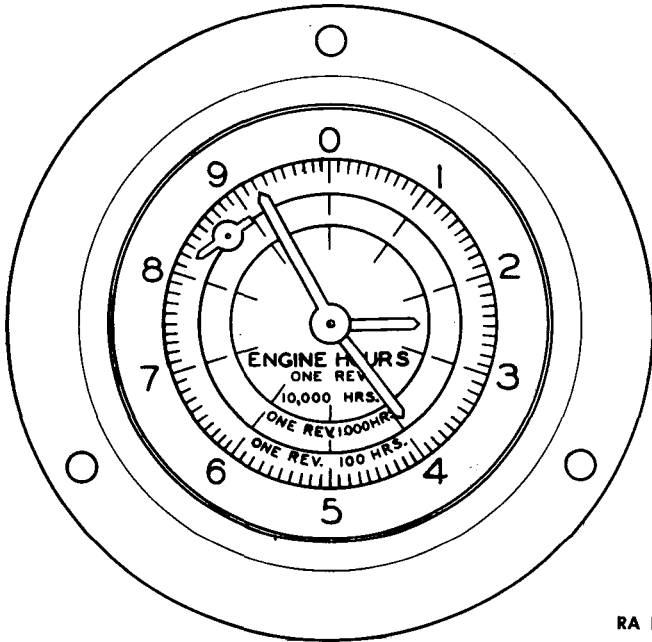

RA PD 17214

Figure 16—Hour Meter

will be 2, followed by three other numerals indicated by the position of the other two hands, which in turn show how many hours more than 2,000 that the tractor has operated.

(3) The middle length hand requires 100 hours of operation for it to pass each numeral, or 1,000 hours for a complete revolution. In figure 16 it stands between 3 and 4, which indicates over 300 hours that must be added to the 2,000. The second numeral then will be 3. Now observe the position of the longest hand to determine in the same manner how many hours must be added to the 2,300 indicated by the other two hands.

(4) This longest hand requires 1 hour of operation for it to pass each mark on the outer circle, 10 hours to pass each numeral or 100 hours for a complete revolution. Here it stands on the second mark past 9, which indicates 92 hours to be added to the 2,300 so that the correct meter reading is 2,392.

c. The small hand at top left of dial will continue to rotate for approximately a minute after engine is stopped, or until oil pressure drops below five pounds.

OPERATING INSTRUCTIONS AND CONTROLS

26. MILE METER.

a. **Description.** This meter is located at the left side of the dash and distances traveled should be entered in log book for record purposes. The mile meter is driven by a flexible cable extending from the back of meter into the transmission case to a spur gear driven by a worm gear on the front end of the lower transmission shaft.

b. **How to Read Mile Meter.** Refer to paragraph 25 b on reading of hour meter. The mile meter should be read in the same manner as the hour meter, except that miles will be noted instead of hours.

HEAVY TRACTOR M1

Section IV

LUBRICATION

| | Paragraph |
|--|-----------|
| General | 27 |
| Lubrication guide | 28 |
| Detailed lubrication and service instructions for using arms | 29 |
| Points to be lubricated by ordnance maintenance personnel | 30 |
| Reports and records | 31 |
| Supplementary lubrication illustrations | 32 |

27. GENERAL.

a. The following lubrication instructions for the Heavy Tractor M1, Allis-Chalmers HD-10W, are published for the information and guidance of all concerned, and supersede all previous instructions.

b. **References.** Materiel must be lubricated in accordance with the latest instructions contained in technical manuals and/or ordnance field service bulletins.

28. LUBRICATION GUIDE.

a. Lubrication instructions for all points to be serviced by the using arms are shown in the lubrication guide (figs. 17 and 18) which specifies the types of lubricants required and the intervals at which they are to be applied.

29. DETAILED LUBRICATION AND SERVICE INSTRUCTIONS FOR USING ARMS.

a. **Air Cleaner.** Proper maintenance of air cleaner is essential to prolonged engine life. Service air cleaner as indicated on lubrication guide.

b. **Fuel Filters.** When elements become plugged, replace with new elements. Do not attempt to wash old elements. The average period of replacement is 400 hours, or until drop in fuel pressure is noted. Service fuel filters, as indicated in note 9 of lubrication guide.

c. **Oil Filter.** Earlier models have two oil filters. Later models have only one.

(1) The filter common to all models is on the right-hand side of the engine and should be serviced as follows:

(a) Remove drain plug from filter adapter and drain filter housing.

(b) Remove stud from top of filter housing and lift off housing. Remove filter element.

LUBRICATION

(c) Wash element in Diesel fuel. Scrub with soft brush. Do not scrape with sharp instrument or wire brush, as damage may result.

(d) Clean filter housing and adapter. Reassemble filter.

(2) The second oil filter, used only in earlier models, should be serviced as follows:

(a) Remove filter element every 240 hours of operation.

(b) Wash filter base and shell. Install new element.

d. **Generator.** The two hinged cap oilers should be lubricated sparingly with OIL, engine, crankcase grade, every 64 hours of operation. Do not oil excessively. CAUTION: Never oil commutator.

e. **Final Drive.** Service final drive as indicated in lubrication guide. Magnetic drain plug is designed to catch all iron particles that might chip or wear off during operation. This plug should be cleaned and magnetism tested each time it is removed to drain final drive case.

f. **Steering Clutches and Master Clutch.** Washing of clutch units about every 240 hours is essential to efficient operation. Wash each clutch as follows:

(1) Lubricate throwout bearings.

(2) Install plug in drain hole of steering clutch compartment.

(3) Fill compartment with 5 gallons of Diesel fuel or SOLVENT, dry-cleaning, bringing level to about 4 inches below the steering clutch shaft.

(4) Start engine and move tractor for several minutes without releasing steering clutches. Stop tractor and drain compartment.

(5) Replace plugs and fill with the same amount of Diesel fuel or SOLVENT, dry-cleaning. Operate tractor with no load for 5 minutes, releasing both steering clutches as often as possible. Remove drain plug and return it to tool box. Drain, and permit clutches to dry.

(6) Lubricate clutch throwout bearings and mechanism.

(7) Drain, flush and refill final drive compartment with lubricant recommended on lubrication guide.

(8) Use similar procedure for washing master clutch. Lubricate release mechanism and linkage by splashing about one quart of OIL, engine, SAE 10, against back of clutch assembly and over release assembly linkage. Allow oil to drain from clutch compartment.

g. **Power Take-Off.** CAUTION: Bearings of the upper power take-off shaft are splash-lubricated. If the tractor is used with the power take-off disengaged, these bearings will receive no lubrication. Power take-off should be engaged at least once a day and operated for a few minutes to assure that these bearings receive lubrication. Breather cap on top of power take-off housing should be washed periodically in clean Diesel fuel.

HEAVY TRACTOR M1

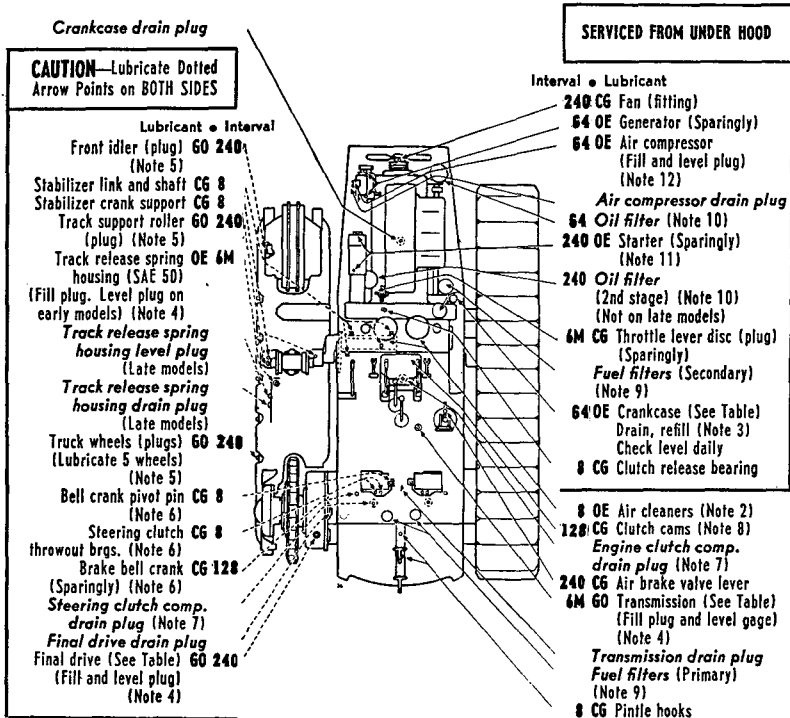

KEY

| LUBRICANTS | |
|--|-------------------------------------|
| OE — OIL, engine | CG — GREASE, general purpose |
| Crankcase grade | No. 1 (above +32°) |
| GO — LUBRICANT, gear, universal | No. 0 (+32° to 0°) |

| INTERVALS |
|------------------------|
| 8 — 8 HOURS |
| 64 — 64 HOURS |
| 128 — 128 HOURS |
| 240 — 240 HOURS |
| 6M — 6 MONTHS |
| CHECK DAILY |
| Crankcase |
| Air cleaner |

TABLE OF CAPACITIES AND LUBRICANTS TO BE USED

| | Capacity | Above +32° | +32° to 0° | Below 0° |
|-------------------------|----------|--|--------------|--------------------|
| | | Caution: Use only U.S. Army Spec. 2-104a | | |
| CRANKCASE | 13 qt. | OE SAE 30 | OE SAE 10 | Refer to para. 135 |
| TRANSMISSION | 24 qt. | GO | GO | |
| FINAL DRIVE (each unit) | 8 qt. | SAE 90 | SAE 80 | |

RA PD 53972

Figure 17.—Lubrication Guide
34

LUBRICATION

NOTES

Additional Lubrication and Service Instructions on Individual Units and Parts

COLD WEATHER: For Lubrication and Service below 0°, refer to Sect. XXV

1. **FITTINGS** — Clean before applying lubricant. (Winch) Lubricate until new grease is forced from the bearing, unless otherwise specified. **CAUTION:** Lubricate after washing tractor.
2. **AIR CLEANERS** — Proper maintenance of air cleaners is essential to prolonged engine life. (Engine air cleaners) Check level every 8 hours. Clean and refill to circular level mark with used crankcase oil or OIL, engine, crankcase grade, every 8 to 30 hours, depending on dust conditions. Remove entire air cleaner twice a year, wash and reoil. Clean air pipes and reassemble. Keep all connections tight. Empty pre-cleaners every 8 hours or more frequently if required. **CAUTION:** Do not allow dirt level to rise above top of glass. (Air compressor air cleaner) Remove filter mat and wash every 128 hours. (Air compressor governor air cleaner) Remove and wash strainer every 240 hours.
3. **CRANKCASE** — Check oil level daily. Drain only when engine is hot. Drain every 64 hours and refill to FULL mark on gage. Run engine a few minutes and recheck oil level. **CAUTION:** Be sure pressure gage indicates oil is circulating.
4. **GEAR CASES** — Check level weekly, except track release spring housing, check every 240 hours; add lubricant if necessary. Check with tractor on level ground. Make visual inspection for leakage weekly. Report leakage to ordnance maintenance personnel. Drain, flush and refill as indicated at points on Lubrication Guide. When draining, drain immediately after operation. Clean and reoil gauze in power take-off fill pipe cap with OIL, engine, crankcase grade, every 64 hours. **CAUTION:** Bearings on the upper power take-off shaft are splash lubricated. If the tractor is used with the power take-off disengaged, these bearings will receive no lubrication. Power take-off should be engaged at least once a day and operated for a few minutes to insure that these bearings receive lubrication.
5. **TRACK SUPPORT ROLLERS, IDLERS AND TRUCK WHEELS** — Remove plugs and flush with **LUBRICANT**, gear, universal, seasonal grade. **CAUTION:** Service front idlers with 10 strokes each, track support rollers with 8-1/2 strokes each and truck wheels with 6 strokes each, using AC flushing lubricator.
6. **STEERING CLUTCH THROWOUT BEARINGS, BELL CRANK PIVOT PIN, BRAKE BELL CRANK** — Use **GREASE**, general purpose, seasonal grade. (Steering clutch throwout bearings and bell crank pivot pin) Lubricate every 8 hours. (Brake bell crank) Lubricate sparingly every 128 hours. To reach fittings, remove driver's seat.
7. **ENGINE AND STEERING CLUTCH COMPARTMENTS** — Remove plugs daily after using tractor to drain accumulated oil. Replace plugs. **CAUTION:** Be sure that plugs are in place when operating in deep mud or water.
 - a. Steering clutches and engine clutch — Washing of clutch units about every 240 hours is essential to efficient operation. Use the following procedure: Lubricate throwout bearings until they are filled. Install plugs in drain holes of steering clutch compartment. Fill compartment with 5 gal. of diesel fuel or SOLVENT, dry-cleaning, bringing level to about 4 in. below steering clutch shaft. Start engine and run tractor back and forth for several minutes without releasing steering clutches. Stop tractor and drain each compartment. Replace plugs and refill with same amount of clean SOLVENT, dry-cleaning. Operate tractor with no load for 5 minutes, releasing both steering clutches as often as possible. Drain and permit clutches to dry. Lubricate clutch throwout bearings and mechanism. Drain, flush and refill final drive compartments with **LUBRICANT**, gear, universal, SAE 90.
8. **ENGINE CLUTCH CAMS** — Remove cover at top of clutch housing, turn crank to reach 3 fittings.
9. **FUEL FILTERS** — First Stage) Located under seat. Remove and replace element every 300 to 500 hours depending upon operating condition. Be sure gasket around the filter housing is in good condition. Drain sediment trap through drain plug at bottom of trap. (Second Stage) Remove and renew cartridge every 300 to 500 hours depending on operating conditions. Fill filter with oil. Be sure gasket around the filter housing is in good condition. Open drain plug daily to remove sediment and water. (Third Stage) Remove and replace element every 300 to 500 hours depending on operating condition. Install spring and element with end marked "top" up. Fill filter with fuel. Install new gasket. If cotton wound filter element is used, place washer over hollow stud in filter housing.
10. **OIL FILTER** — Clean oil filters at each crankcase oil change. Remove drain plug in filter base and drain filter body. Remove nut from top of filter body and lift off center shell. Remove filter elements. Wash elements in diesel fuel being careful not to scratch or distort elements. Dry all parts and reassemble filter. After cleaning filter, refill crankcase to FULL mark on gage. Run engine a few minutes and recheck oil level. (Early models) Every 240 hours or every fourth oil change, wash filter base and shell and install new cartridge in secondary stage filter.
11. **STARTER** — Use OIL, engine, SAE 30, sparingly every 240 hours. If removed, lubricate outboard bearing through oiler with OIL, engine, SAE 30.
12. **COMPRESSED AIR TANK** — Drain water from air tank daily.
13. **UNIVERSAL JOINTS AND SLIP JOINT** — Remove guard. Lubricate with **GREASE**, general purpose, seasonal grade. (Early models) Remove plugs and insert fittings to lubricate. Replace plugs. (Late models) Lubricate through fittings.
14. **WINCH JAW CLUTCH** — When operating in dusty or muddy conditions, the sliding jaw clutch must be cleaned frequently and oiled with OIL, engine, seasonal grade, to insure smooth operation.
15. **OIL CAN POINTS** — Lubricate control shafts and clevises with OIL, engine, crankcase grade, every 64 hours.
16. **POINTS REQUIRING NO LUBRICATION** — Tracks, clutch pilot bearing, chain.

RA PD 53972B

Notes for Figures 17 and 18

HEAVY TRACTOR M1

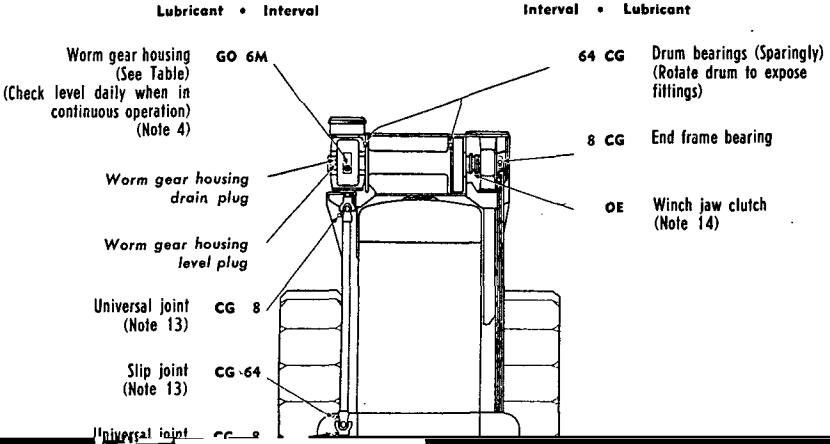

LUBRICATION

h. Winch. Gear cases and other points are lubricated at intervals corresponding with those for the tractor itself. They should be lubricated, as indicated on the lubrication guide.

i. Winch Jaw Clutch. When operating under dusty or muddy conditions, the sliding jaw clutch must be cleaned frequently and lubricated with OIL, engine, seasonal grade, to insure smooth operation.

j. Drive Chain. Clean frequently and oil with LUBRICANT, gear, universal, SAE 90.

k. Clutch Hub and Pilot Bearing. At 100 hour inspection or when engine is removed, disassemble, clean and repack with GREASE, ball and roller bearing, and reassemble.

30. POINTS TO BE LUBRICATED BY ORDNANCE MAINTENANCE PERSONNEL.

a. Water Pump. Packed at assembly. If disassembled, clean and repack bearings with GREASE, ball and roller bearing.

b. Starter. Clean and repack all ball bearings with GREASE, special, high temperature.

c. Generator.

(1) Clean and repack ball bearings with GREASE, special, high temperature.

(2) Coat pole and exposed armature shaft surfaces with OIL, engine, SAE 30, to prevent rusting.

31. REPORTS AND RECORDS.

a. Reports. If lubrication instructions are closely followed, proper lubricants used, and satisfactory results are not obtained, a report will be made to the ordnance officer responsible for the maintenance of the materiel.

b. Records. A complete record of lubrication servicing will be kept for the materiel.

32. SUPPLEMENTARY LUBRICATION ILLUSTRATIONS.

a. The location of lubrication fittings and methods of lubrication are shown in figures 17 to 23 inclusive.

HEAVY TRACTOR M1

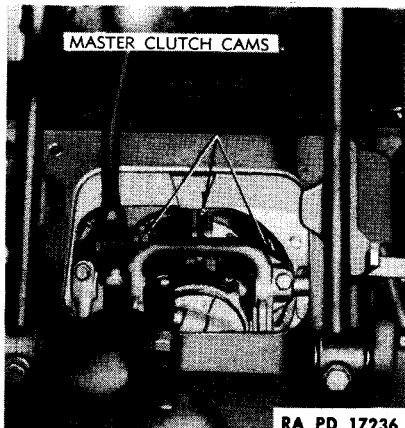
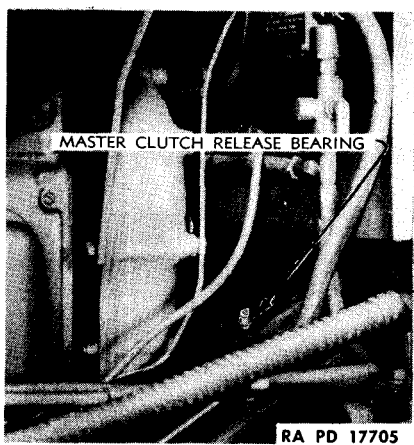
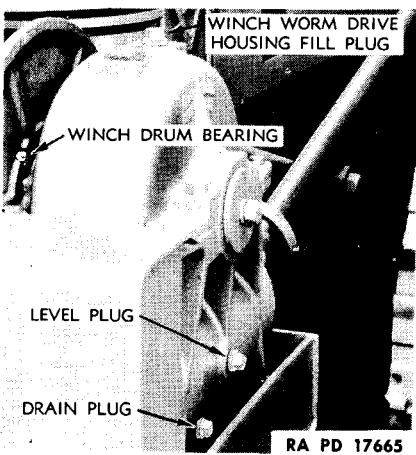
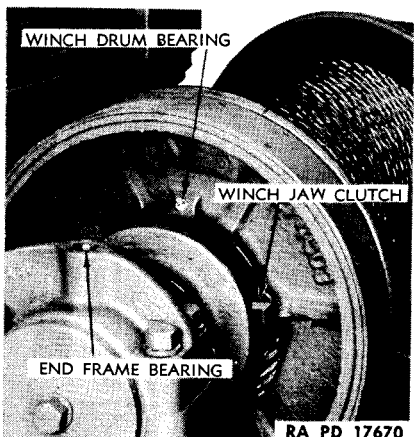
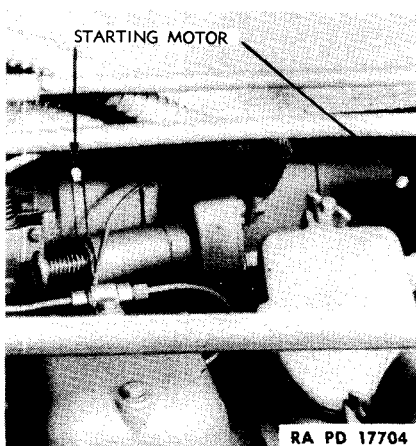
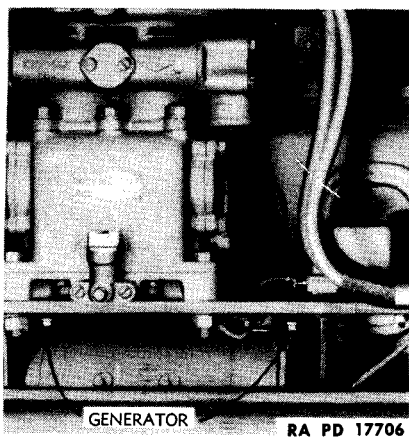
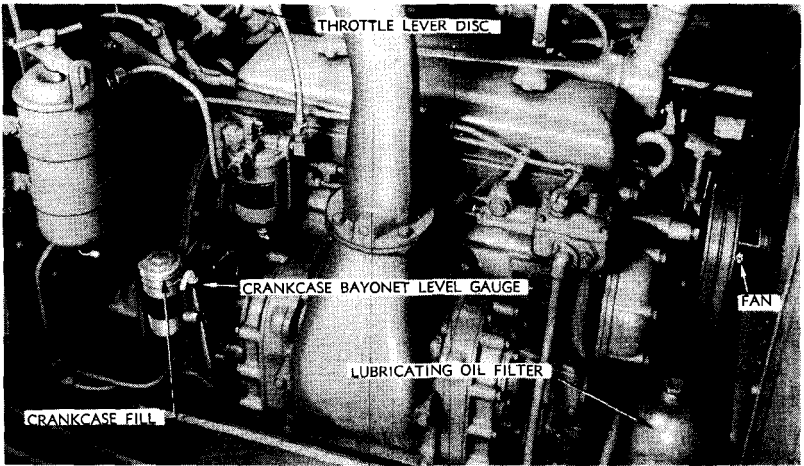
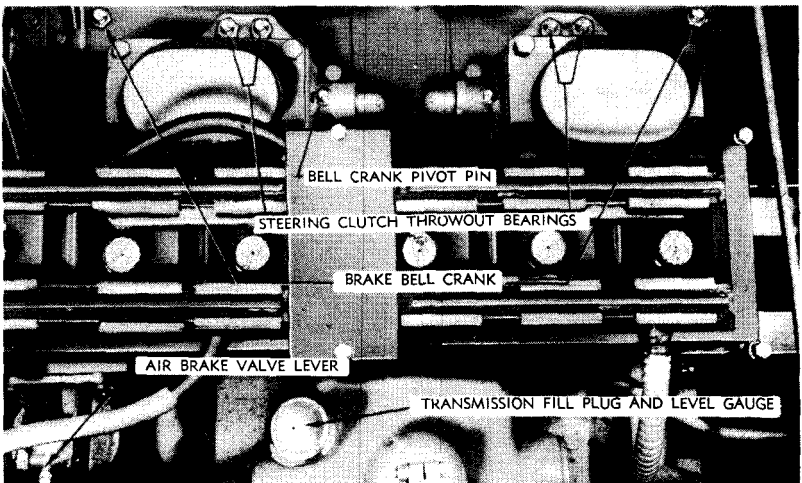

Figure 19—Lubrication Fittings

LUBRICATION



RA PD 17217



RA PD 17655

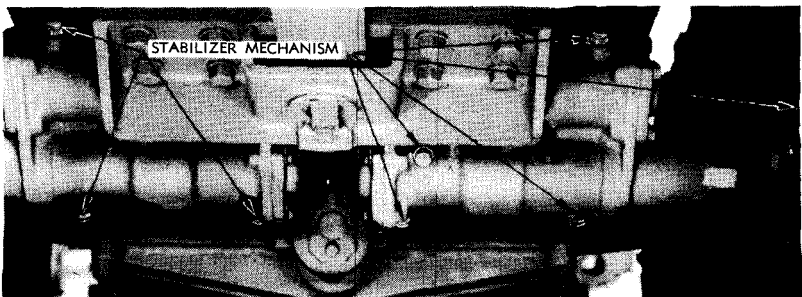

RA PD 17221

Figure 20—Lubrication Fittings

HEAVY TRACTOR M1

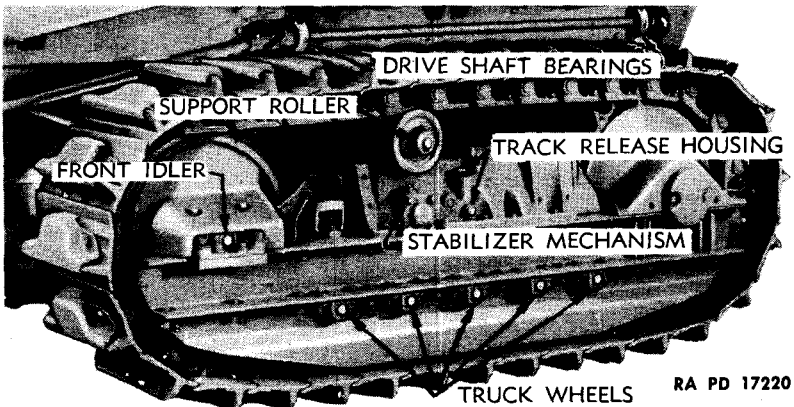
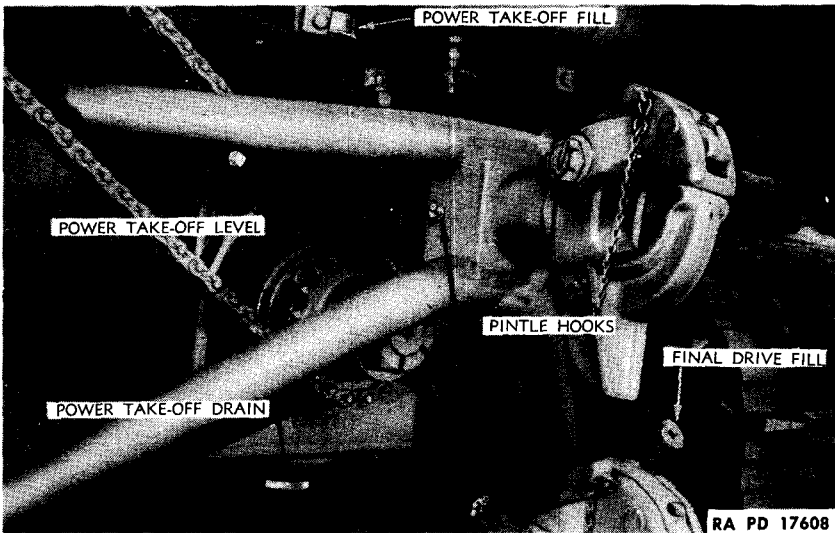
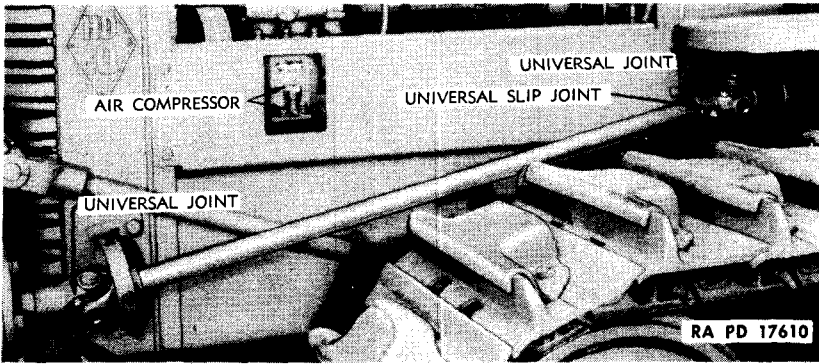
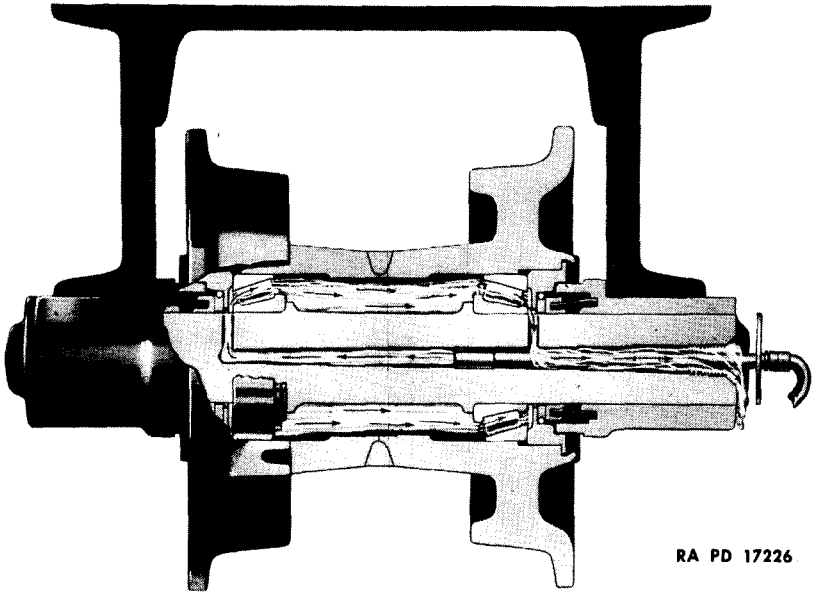

Figure 21 - Lubrication Fittings

LUBRICATION



RA PD 17226

Figure 22—Cutaway Truck Wheel with Flushing Lubricator

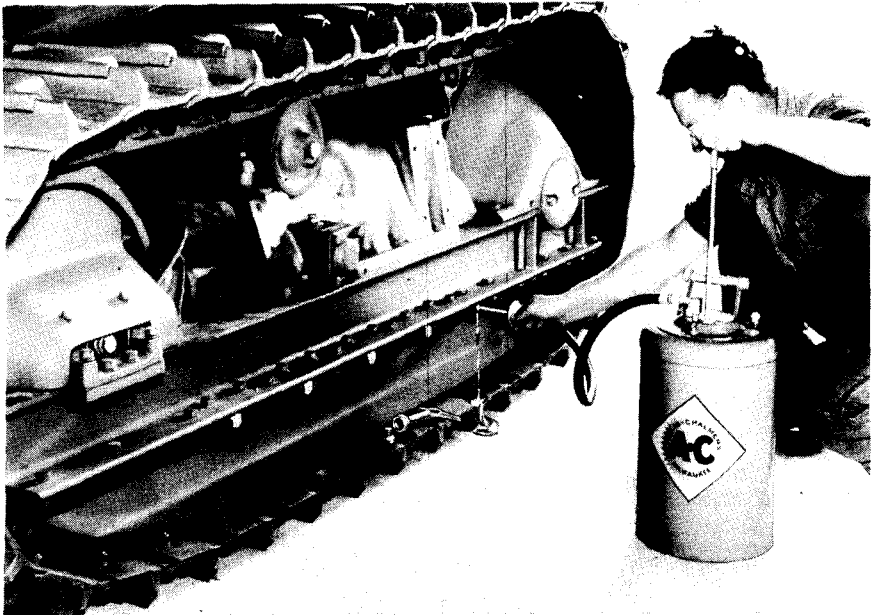

RA PD 17265

Figure 23—Lubricating Truck Wheels

HEAVY TRACTOR M1

Section V

PREVENTIVE MAINTENANCE

| | Paragraph |
|---|-----------|
| General | 33 |
| Prestarting inspection | 34 |
| Inspection during operation..... | 35 |
| Inspection after operation..... | 36 |
| Inspection after each 50 hours of operation..... | 37 |
| Inspection after each 100 hours of operation..... | 38 |
| Inspection for operation in water..... | 39 |
| Inspection for operation in deep snow..... | 40 |
| Inspection for operation in sandy terrain..... | 41 |
| Inspection for operation in deep mud..... | 42 |

33. GENERAL.

a. To insure mechanical efficiency, it is necessary that the tractor be systematically inspected at regular intervals in order that defects may be discovered and corrected, and the necessary adjustments made before damage results.

b. Cracks that develop in castings or other metal parts may often be detected by dust and oil deposits after the completion of a run. General wear of all parts should be noted at all inspection periods, and parts needing replacement because they are nearly worn out, should be reported before break-down occurs.

34. PRESTARTING INSPECTION.

a. Before the engine is started, the operator or organization personnel should check the following:

- (1) Check the fuel supply.
- (2) Remove the bayonet gage to determine engine crankcase oil level. If found to be below "FULL" mark, add one quart of the correct oil for each mark that level is below "FULL."
- (3) Check air compressor oil level. Add oil if necessary.
- (4) Inspect water or antifreeze solution in cooling system. Add liquid if no water can be seen when radiator cap is removed.
- (5) Inspect the entire unit for loose bolts or nuts if repairs have been made since the previous operating period.
- (6) Check oil level in final drives. Keep filled to level of filler plug.
- (7) Check transmission oil level. This level should be kept between "LOW" and "FULL" marks on bayonet gage.

PREVENTIVE MAINTENANCE

- (8) Make inspection of tractor tool equipment. Report any tools or special equipment missing.
- (9) Inspect for presence of fire extinguisher.
- (10) Make sure that all operating levers work freely and correctly.
- (11) Make sure that all lights and brakes are in operating condition.
- (12) Make sure that equipment which tractor is pulling is securely hitched and safety cables or chains are in place.
- (13) Observe operating instruments. Oil pressure gage should read zero, fuel pressure gage zero, ammeter zero, etc.
- (14) Drain fuel tank sediment sumps.
- (15) Drain second stage fuel filters.

35. INSPECTION DURING OPERATION.

a. An operator should make it a habit to glance often at the operating instruments to be sure all parts of tractor are functioning properly. He should be alert for indications of abnormal operation of the engine and tractor. If instruments fluctuate abnormally, the cause should be immediately determined. After engine reaches operating temperature (170 F to 180 F), oil pressure should be 25 to 35 pounds, fuel pressure 20 to 30 pounds at three quarters or full throttle. Radiator shutter should be regulated to keep engine at operating temperature.

b. Operator should note if master clutch engages and disengages properly and if pull required to engage clutch is 50 to 55 pounds when engine is running.

c. The steering levers and brake pedals should be checked for clearances and operation.

d. Any slippage of clutches should be detected and corrective measures taken immediately.

36. INSPECTION AFTER OPERATION.

a. The following points should be inspected after operation and all oil levels brought up to "FULL."

- (1) Engine and air compressor crankcases oil level.
- (2) Transmission case oil level.
- (3) Final drive gear cases oil level.
- (4) Winch gear housing oil level.
- (5) Power take-off oil level.
- (6) Cooling system. Add water if necessary.
- (7) Batteries. Keep water level three eighths of an inch above separators.

HEAVY TRACTOR M1

- (8) Precleaners. Empty dirt out of compartments.
- (9) Air cleaners. Remove oil cups, clean and refill to proper level.
- (10) Open fuel tank drain cocks to remove water and dirt from sediment sumps.
- (11) Open air tank cocks to allow any accumulated water to drain out.
- (12) Inspect for loose bolts, nuts, or broken parts.

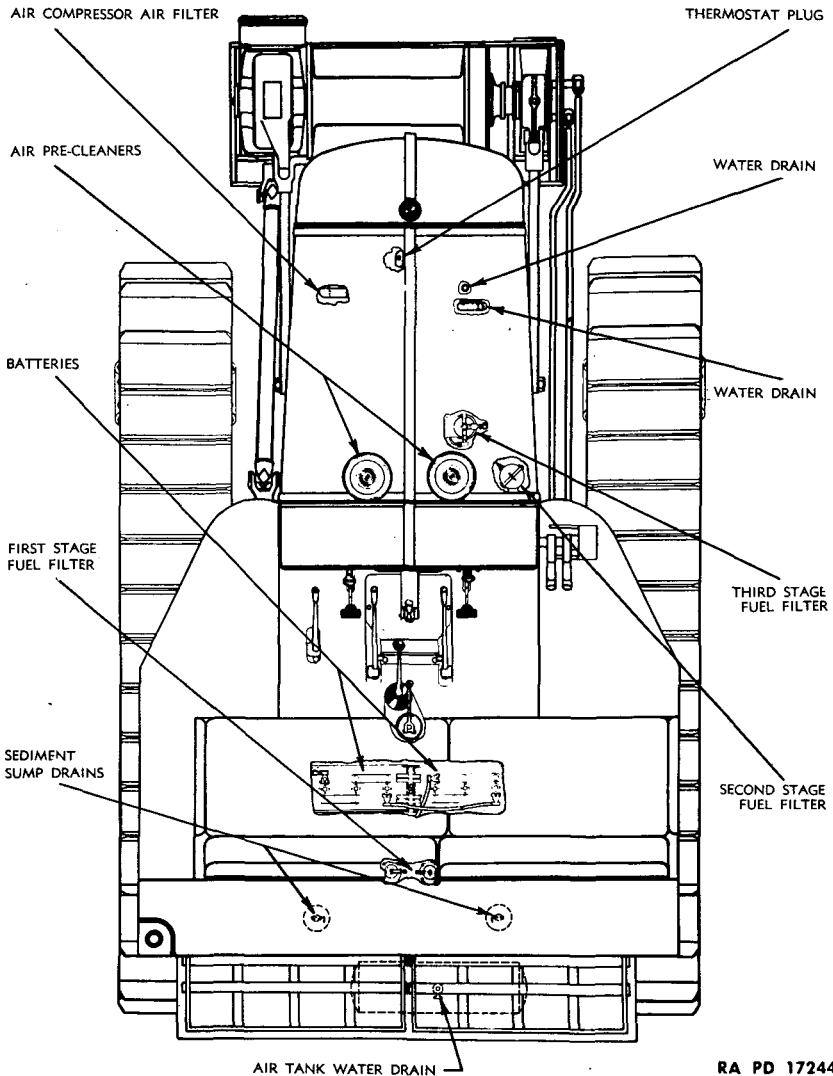

RA PD 17244

Figure 24—Service Chart

PREVENTIVE MAINTENANCE

37. INSPECTION AFTER EACH 50 HOURS OF OPERATION.

a. Check.

- (1) Master clutch adjustment (par. 108).
- (2) Steering clutch throwout adjustment (par. 112).
- (3) Brake adjustment (par. 115).
- (4) Front idler and track adjustment (par. 120).
- (5) Winch worm shaft safety brake (par. 125).

38. INSPECTION AFTER EACH 100 HOURS OF OPERATION.

a. Check.

- (1) Generator belt adjustment (par. 87).
- (2) Air compressor belt adjustment (par. 103).
- (3) Fan belt adjustment (par. 80).
- (4) Remove air compressor filter mat and wash in gasoline. Do this more often in extremely dusty conditions (par. 103).
- (5) Wire insulation and connections.
- (6) Check fuel filters under seat. Install new filter elements if necessary.

b. See that air box vent tube is not clogged. Remove and clean if necessary.

c. Measure engine valve clearance. Adjust to 0.010 inch, with engine at operating temperature (par. 60).

39. INSPECTION FOR OPERATION IN WATER.

a. Before driving the tractor into water, the operator should estimate what the maximum depth will be, the kind of footing the tractor will have for traction, and the length of time the tractor will be in the water.

b. If the water is over 20 inches deep, the two large pipe plugs in the tractor tool box should be installed in the two drain holes in the bottom of the transmission case. This will prevent water getting into the steering clutch compartment. The small pipe plug should be installed in the drain hole of the master clutch compartment.

c. With these plugs installed, the tractor is capable of operating in water up to a depth of about 41 inches. The ends of the fan blades, when at the lowest point, are $41\frac{3}{4}$ inches above the ground (measured from the tip of the grousers). As long as the fan blades do not hit the water, no damage will result. If the fan blades do hit the water, the angle of the blades is such that they will bend out and cut into the radiator core.

d. After operating in water, the drain plugs should be removed. The tractor should be allowed to stand for a short while and the drain plugs in the final drive cases and track release housings loosened and removed partially to see if any water or dirt has entered these housings.

HEAVY TRACTOR M1

SERVICE

Tractor, Heavy, M1

AIR PRE-CLEANERS

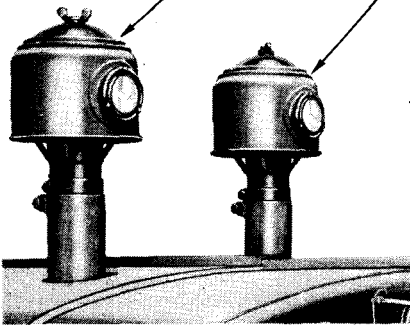

RAPD 17242

Air Pre-Cleaners — Remove and clean dirt compartment after operation or more often in extremely dusty condition. Level of dirt in compartment should never be allowed to become higher than top of glass.

Fuel Filters — Replace fuel filter elements in first stage fuel filter, second stage fuel filter and third stage fuel filter monthly or whenever a drop in fuel pressure indicates fuel filters are clogged.

Batteries — Check water level in batteries, located under seat, after operation and add distilled water regularly to keep water level $\frac{3}{8}$ " above separators. Keep top of batteries and terminals clean.

RA PD 17246

SECOND STAGE FUEL FILTER

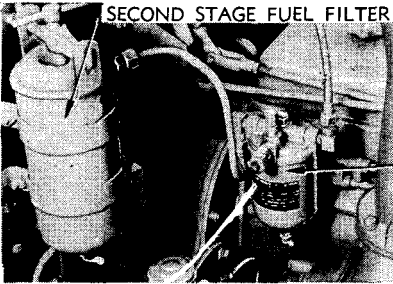

THIRD STAGE FUEL FILTER



RAPD 17240

FIRST STAGE FUEL FILTER

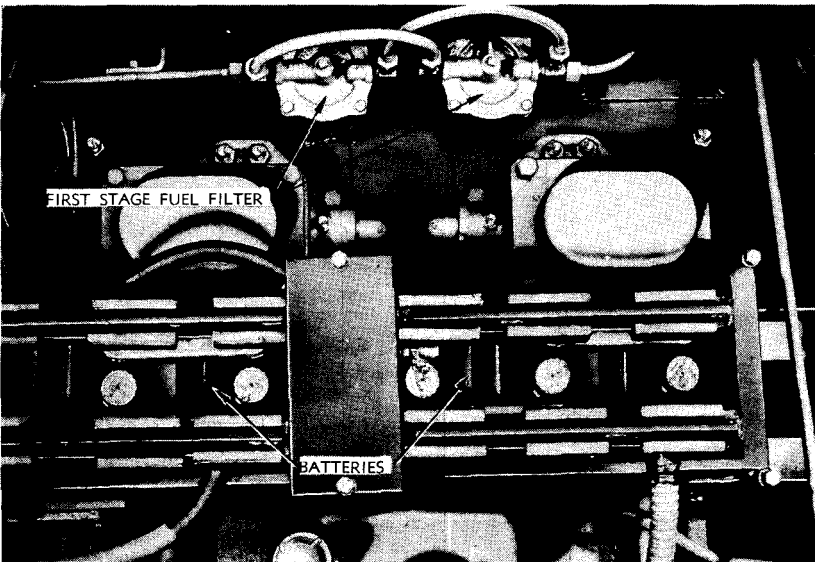
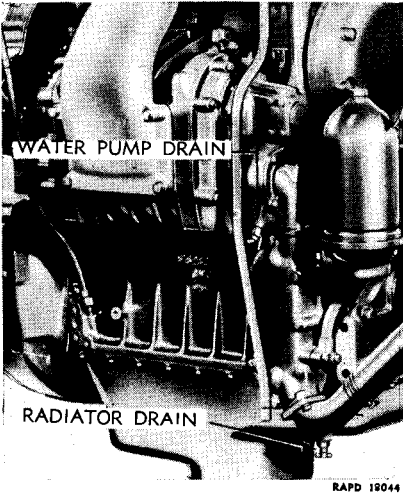

Figure 25—Service Instructions

PREVENTIVE MAINTENANCE



RAPD 19044

SERVICE

Tractor, Heavy, M1

Cooling System—Both water pump drain and radiator drain should be opened to completely drain system. When filling system thermostat plug must be removed, until water reaches level of plug, to allow air to escape. Drain, flush, and refill cooling system monthly.

Air Compressor Filter—Remove air compressor filter and wash out with gasoline or fuel oil every 100 hours or oftener in dusty conditions. Saturate filter mat with light engine oil before replacing.

Air Reservoir—Open drain cock on bottom of tank after operation to allow any accumulated water to drain out.

Sediment Sumps—Drain water and dirt from sediment sumps, located under fuel tank, after operation. This should be done before each operating period.

RA PD 18045

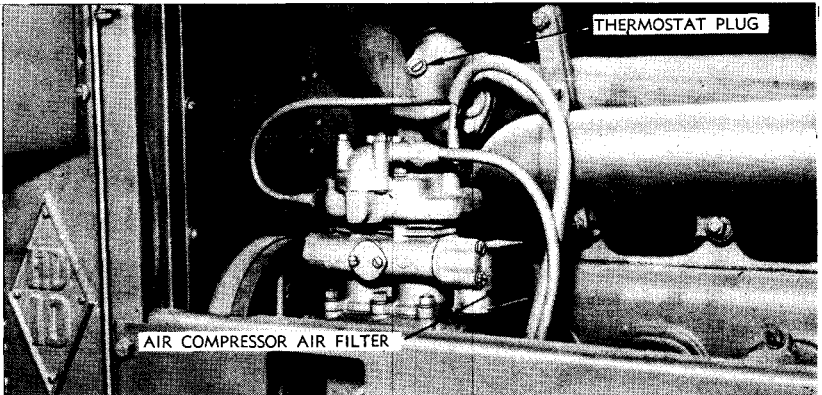

RAPD 41065

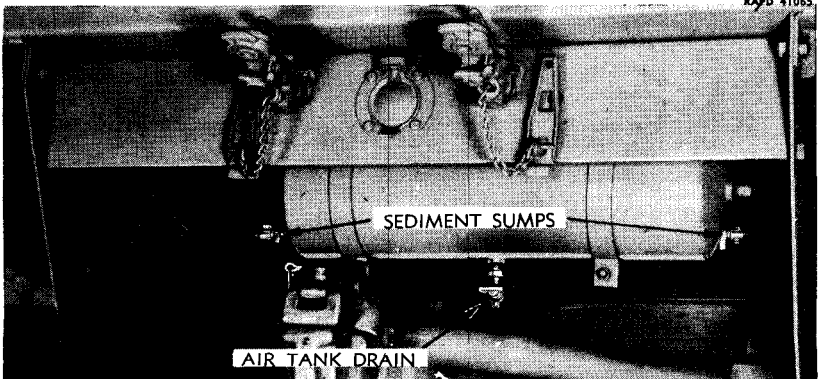

RAPD 17225

Figure 26—Service Instructions

HEAVY TRACTOR M1

This is especially important in cold weather when the water might freeze. If any water or dirt has entered these compartments, they should be drained, flushed out, and refilled with clean oil.

e. The plugs used in the master clutch and steering clutch compartments should *always* be put in tractor tool box when removed to prevent loss and insure having them with tractor when again needed.

40. INSPECTION FOR OPERATION IN DEEP SNOW.

a. Before driving in deep snow, install the two large pipe plugs in the drain holes in the bottom of the transmission case to prevent snow getting into the steering clutch compartment. The small pipe plug should be installed in the drain hole of the master clutch compartment.

b. After the vehicle has been operated in deep snow, the following inspection should be made:

(1) Remove snow which has become hard-packed in the track openings, and inspect track rollers and truck wheels for any damage.

(2) Inspect bottom of vehicle for any damage which may have been caused by striking objects hidden in the snow.

(3) Inspect final drive cases and track release housing for water and dirt. Drain, flush out, and refill with clean oil if necessary.

41. INSPECTION FOR OPERATION IN SANDY TERRAIN.

a. Before driving in sand, install pipe plugs in the drain holes in the transmission case and the master clutch compartment.

b. After the vehicle has been operated in sandy terrain and dust laden atmosphere, the following inspection should be made:

(1) Inspect precleaner and remove any accumulated dirt.

(2) Inspect air cleaner, and clean and refill with new oil if necessary.

(3) Inspect fuel and oil filters. Clean filters or replace filtering element where required.

42. INSPECTION FOR OPERATION IN DEEP MUD.

a. Before driving in deep mud, install the pipe plugs in the drain holes in the transmission case and the master clutch compartment.

b. After the vehicle has been operated in deep mud, it should be thoroughly washed, all mud removed, and the following inspections made:

(1) Inspect lubrication fittings to determine if they have become clogged with mud. Remove any mud present, and lubricate part.

(2) Check rollers and truck wheels for free movement to determine if any mud has found its way into the bearings.

(3) Inspect final drive cases and track release housing for water and mud. Drain, flush out, and refill with clean oil if necessary.

Section VI

GENERAL CARE AND PRESERVATION

| | Paragraph |
|----------------|-----------|
| Records | 43 |
| Cleaning | 44 |

43. RECORDS.

a. **Use.** An accurate record must be kept of each motor vehicle issued by the Ordnance Department. For this purpose the Ordnance Motor Book (O. O. Form No. 7255), generally called "Log Book," is issued with each vehicle and must accompany it at all times. This book furnishes a complete record of the vehicle from which valuable information concerning operation and maintenance costs, etc., is obtained, and organization commanders must insist that correct entries be made. This book will habitually be kept in a canvas cover to prevent it from being injured or soiled.

b. **Assignment Record.** The page bearing a record of assignment must be destroyed prior to entering a combat zone. All other references which may be posted regarding the identity of the organization must also be deleted.

44. CLEANING.

a. Grit, dirt, and mud are the sources of greatest wear to a vehicle. If deposits of dirt and grit are allowed to accumulate, particles will soon find their way into bearing surfaces, causing unnecessary wear, and, if the condition is not remedied, will soon cause serious difficulty. When removing engine parts or any other unit, in making repairs and replacements, or, if in the course of inspection, working joints or bearing surfaces are to be exposed, all dirt and grit that might find its way to the exposed surfaces must first be carefully removed. The tools must be clean, and care must always be taken to eliminate the possibilities of brushing dirt or grit into the opening with the sleeve or other part of the clothing. To cut oil-soaked dirt and grit, hardened grit, or road oil, use SOLVENT, dry-cleaning, applied with cloths (not waste) or a brush. Care should be taken to keep water from entering electrical accessories such as starter, generator, etc. Detailed information on cleaning is included in TM 9-850.

b. Oil cups or grease fittings which have become clogged should be opened with a piece of wire. Wood should never be used for this purpose, as splinters are likely to break off and permanently clog these passages. Particular care should be taken to clean and decontaminate vehicles that have been caught in a gas attack. See section VIII for details of this operation.

HEAVY TRACTOR M1

Section VII

PAINTING

| | Paragraph |
|------------------------------------|-----------|
| General | 45 |
| Preparing for painting | 46 |
| Painting metal surfaces | 47 |
| Paint as a camouflage | 48 |
| Removing paint | 49 |
| Painting lubricating devices | 50 |

45. GENERAL.

a. Ordnance materiel is painted before issue to the using arms and one maintenance coat per year will ordinarily be ample for protection. With but few exceptions this materiel will be painted with ENAMEL, synthetic, olive-drab, lusterless. The enamel may be applied over old coats of long oil enamel and oil paint previously issued by the Ordnance Department if the old coat is in satisfactory condition for repainting.

b. Paints and enamels are usually issued ready for use and are applied by brush or spray. They may be brushed on satisfactorily when used unthinned in the original package consistency or when thinned no more than 5 percent by volume with THINNER. The enamel will spray satisfactorily when thinned with 15 percent by volume of THINNER. (Linseed oil must not be used as a thinner since it will impart a luster not desired in this enamel.) If sprayed, it dries hard enough for repainting within ½ hour and dries hard in 16 hours.

c. Complete information on painting is contained in TM 9-850.

46. PREPARING FOR PAINTING.

a. If the base coat on the materiel is in poor condition, it is more desirable to strip the old paint from the surface than to use sanding and touch-up methods. After stripping, it will then be necessary to apply a primer coat.

b. PRIMER, ground, synthetic, should be used on wood as a base coat for synthetic enamel. It may be applied either by brushing or spraying. It will brush satisfactorily as received or after the addition of not more than 5 percent by volume of THINNER. It will be dry enough to touch in 30 minutes, and hard in 5 to 7 hours. For spraying, it may be thinned with not more than 15 percent by volume of THINNER. Lacquers must not be applied to the PRIMER, ground, synthetic, within less than 48 hours.

PAINTING

c. **PRIMER**, synthetic, rust-inhibiting, for bare metal, should be used on metal as a base coat. Its use and application is similar to that outlined in subparagraph **b** above.

d. The success of a job of painting depends partly on the selection of a suitable paint, but also largely upon the care used in preparing the surface prior to painting. All parts to be painted should be free from rust, dirt, grease, kerosene, oil, and alkali, and must be dry.

47. PAINTING METAL SURFACES.

a. If metal parts are in need of cleaning, they should be washed in a liquid solution consisting of $\frac{1}{2}$ pound of **SODA ASH** in 8 quarts of warm water, or an equivalent solution, then rinsed in clear water and wiped thoroughly dry. Wood parts in need of cleaning should be treated in the same manner, but the alkaline solution must not be left on for more than a few minutes and the surfaces should be wiped dry as soon as they are washed clean. When artillery or automotive equipment is in fair condition and only marred in spots, the bad places should be touched with **ENAMEL**, synthetic, olive-drab, lusterless, and permitted to dry. The whole surface will then be sandpapered with **PAPER**, flint, No. 1, and a finish coat of **ENAMEL**, synthetic, olive-drab, lusterless, applied and allowed to dry thoroughly before the materiel is used. If the equipment is in bad condition, all parts should be thoroughly sanded with **PAPER**, flint, No. 2, or equivalent, given a coat of **PRIMER**, ground, synthetic, and permitted to dry for at least 16 hours. They will then be sandpapered with **PAPER**, flint, No. 00, wiped free from dust and dirt, and a final coat of **ENAMEL**, synthetic, olive-drab, lusterless, applied and allowed to dry thoroughly before the materiel is used.

48. PAINT AS A CAMOUFLAGE.

a. Camouflage is now a major consideration in painting ordnance vehicles, with rust prevention secondary. The camouflage plan at present employed utilizes three factors: color, gloss, and stenciling.

(1) **COLOR**. Vehicles are painted with **ENAMEL**, synthetic, olive-drab, lusterless, which was chosen to blend in reasonably well with the average landscape.

(2) **GLOSS**. The lusterless enamel makes a vehicle difficult to see from the air or from relatively great distances over land. A vehicle painted with ordinary glossy paint can be detected more easily and at greater distances.

(3) **STENCILING**. White stencil numbers on vehicles have been eliminated because they can be photographed from the air. A blue-drab stencil enamel is now used which cannot be so photographed. It is illegible to the eye at distances exceeding 75 feet.

HEAVY TRACTOR M1

b. Preserving Camouflage.

(1) Continued friction or rubbing must be avoided, as it will smooth the surface and produce a gloss. The vehicle should not be washed more than once a week. Care should be taken to see that the washing is done entirely with a sponge or a soft rag. The surface should never be rubbed or wiped, except while wet, or a gloss will develop.

(2) It is not desirable that vehicles, painted with lusterless enamel, be kept as clean as vehicles were kept when glossy paint was used. A small amount of dust increases the camouflage value. Grease spots should be removed with SOLVENT, dry-cleaning. Whatever portion of the spot cannot be so removed should be allowed to remain.

(3) Continued friction of wax-treated tarpaulins on the sides of a vehicle will also produce a gloss, which should be removed with SOLVENT, dry-cleaning.

(4) Tests indicate that repainting with olive-drab paint will be necessary once yearly, with blue-drab paint twice yearly.

49. REMOVING PAINT.

a. After repeated paintings, the paint may become so thick as to crack and scale off in places, presenting an unsightly appearance. If such is the case, remove the old paint by use of a lime-and-lye solution (see TM 9-850 for details) or REMOVER, paint and varnish. It is important that every trace of lye or other paint remover be completely rinsed off and that the equipment be perfectly dry before repainting is attempted. It is preferable that the use of lye solutions be limited to iron or steel parts. If used on wood, the lye solution must not be allowed to remain on the surface for more than a minute before being thoroughly rinsed off and the surface wiped dry with rags. Crevices or cracks in wood should be filled with putty and the wood sandpapered before refinishing. The surfaces thus prepared should be painted according to directions in paragraph 47.

50. PAINTING LUBRICATING DEVICES.

a. Oil cups, grease fittings, oilholes, and similar lubricating devices, as well as a circle about three-fourths of an inch in diameter at each point of lubrication, will be painted with ENAMEL, red, water-resisting, in order that they may be readily located.

Section VIII

MATERIEL AFFECTED BY GAS

| | Paragraph |
|---|-----------|
| Protective measures | 51 |
| Cleaning | 52 |
| Decontamination | 53 |
| Special precautions for automotive materiel | 54 |

51. PROTECTIVE MEASURES.

a. When materiel is in constant danger of gas attack, unpainted metal parts will be lightly coated with engine oil. Instruments are included among the items to be protected by oil from chemical clouds or chemical shells. Care will be taken that the oil does not touch the optical parts of instruments or leather or canvas fittings. Materiel not in use will be protected with covers as far as possible.

b. Ordinary fabrics offer practically no protection against mustard gas or lewisite. Rubber and oilcloth, for example, will be penetrated within a short time. The longer the period during which they are exposed, the greater the danger of wearing these articles. Rubber boots worn in an area contaminated with mustard gas may offer a grave danger to men who wear them several days after the bombardment. Impermeable clothing will resist penetration more than an hour, but should not be worn longer than this.

52. CLEANING.

a. All unpainted metal parts of materiel that have been exposed to any gas except mustard and lewisite must be cleaned as soon as possible with SOLVENT, dry-cleaning, or ALCOHOL, denatured, and wiped dry. All parts should then be coated with engine oil.

53. DECONTAMINATION.

a. For the removal of liquid chemicals (mustard, lewisite, etc.) from materiel, the following steps should be taken:

(1) PROTECTIVE MEASURES.

(a) For all of these operations a complete suit of impermeable clothing and a service gas mask will be worn. Immediately after removal of the suit, a thorough bath with soap and water (preferably hot) must be taken. If any skin areas have come in contact with mustard, if even a very small drop of mustard gets into the eye, or if the vapor of mustard has been inhaled, it is imperative that complete first-aid measures be given within 20 to 30 minutes after exposure. First-aid instructions are given in TM 9-850 and FM 21-40.

HEAVY TRACTOR M1

(b) Garments exposed to mustard will be decontaminated. If the impermeable clothing has been exposed to vapor only, it may be decontaminated by hanging in the open air, preferably in sunlight for several days. It may also be cleaned by steaming for 2 hours. If the impermeable clothing has been contaminated with liquid mustard, steaming for 6 to 8 hours will be required. Various kinds of steaming devices can be improvised from materials available in the field.

(2) PROCEDURE.

(a) Commence by freeing materiel of dirt through the use of sticks, rags, etc., which must be burned or buried immediately after this operation.

(b) If the surface of the materiel is coated with grease or heavy oil, this grease or oil should be removed before decontamination is begun. SOLVENT, dry-cleaning, or other available solvents for oil should be used with rags attached to ends of sticks.

(c) Decontaminate the painted surfaces of the materiel with bleaching solution made by mixing one part AGENT, decontaminating (chloride of lime), with one part water. This solution should be swabbed over all surfaces. Wash off thoroughly with water, then dry and oil all surfaces.

(d) All unpainted metal parts and instruments exposed to mustard or lewisite must be decontaminated with AGENT, decontaminating, noncorrosive, mixed one part solid to fifteen parts solvent (ACETYLENE TETRACHLORIDE). If this is not available, use warm water and soap. Bleaching solution must not be used, because of its corrosive action. Coat all metal surfaces lightly with engine oil.

(e) In the event AGENT, decontaminating (chloride of lime) is not available, materiel may be temporarily cleaned with large volumes of hot water. However, mustard lying in joints or in leather or canvas webbing is not removed by this procedure and will remain a constant source of danger until the materiel can be properly decontaminated. All mustard washed from materiel in this manner lies unchanged on the ground, necessitating that the contaminated area be plainly marked with warning signs before abandonment.

(f) The cleaning or decontaminating of materiel contaminated with lewisite will wash arsenic compounds into the soil, poisoning many water supplies in the locality for either men or animals.

(g) Leather or canvas webbing that has been contaminated should be scrubbed thoroughly with bleaching solution. In the event this treatment is insufficient, it may be necessary to burn or bury such materiel.

(h) Detailed information on decontamination is contained in FM 21-40, TM 9-850, and TC 38, 1941, Decontamination.

HEAVY TRACTOR M1

PART TWO—Organization Instructions

Section IX

GENERAL INFORMATION ON MAINTENANCE

Paragraph

Scope 55

55. SCOPE.

a. The scope of maintenance and repairs by the crew and other units of the using arms is determined by the ease with which the project can be accomplished, the amount of time available, weather conditions, temperatures, the equipment available, the skill of the personnel, and other circumstances which may be present.

b. The definitions given below are included in order that the operation prescribed may be correctly interpreted by those doing the work.

(1) *Service*. Consists of cleaning, lubricating, tightening bolts and nuts, and making external adjustments of subassemblies or assemblies and controls.

(2) *Repair*. Consists of making repairs to, or replacements of, a part, subassembly or assembly that can be accomplished without completely disassembling the subassembly or assembly, and does not require heavy welding or riveting, machining, fitting, and/or alining.

(3) *Replace*. Consists of removing the part, subassembly or assembly from the tractor and replacing it with a new, reconditioned, or rebuilt part, whichever the case may be.

(4) *Rebuild*. Consists of completely reconditioning and placing in serviceable condition any unserviceable part, subassembly or assembly of the tractor including welding, riveting, machining, fitting, alining, assembling, and testing.

c. The following are the maintenance duties which may be performed by the using arm personnel. NOTE: The using arm personnel is authorized to remove and reinstall an engine or transmission assembly. However, the replacement of an engine with another engine, or the replacement of a transmission assembly with another transmission assembly, must not be done by using arms unless authorization is received from ordnance personnel.

GENERAL INFORMATION ON MAINTENANCE**ENGINE**

| | |
|--|-------------------|
| Engine (par. 55 c, Note) | Replace |
| Engine (pars. 63 and 64) | Clean and service |
| Valve rocker assembly (par. 59) | Replace |
| Valve clearance (par. 60) | Adjust |
| Exhaust manifold and muffler (par. 62) | Replace |

FUEL AND AIR SYSTEM

| | |
|--|--------------------|
| Fuel tank (par. 66) | Clean and replace |
| Fuel filters (par. 68) | Service or replace |
| Fuel pump (par. 69) | Replace |
| Injectors (par. 70) | Adjust or replace |
| Fuel lines and connections (par. 71) | Repair or replace |
| Precleaners (par. 72) | Service or replace |
| Air cleaner (par. 73) | Service or replace |

COOLING SYSTEM

| | |
|-------------------------------------|--------------------|
| Water pump assembly (par. 75) | Replace |
| Manifold (par. 76) | Replace |
| Radiator (par. 77) | Clean and flush |
| Thermostat assembly (par. 78) | Replace |
| Hoses and pipes (par. 79) | Replace |
| Fan assembly (par. 80) | Replace |
| Fan belt (par. 80) | Service or replace |

LUBRICATING SYSTEM

| | |
|----------------------------|---------|
| Oil lines | Replace |
| Oil filter (par. 83) | Replace |
| Oil cooler (par. 84) | Replace |

ELECTRICAL SYSTEM

| | |
|--|----------------------------|
| Batteries (par. 86) | Service or replace |
| Generator (par. 87) | Replace |
| Generator voltage control unit (par. 88) | Replace |
| Starting motor assembly (par. 89) | Replace |
| Ammeter (par. 90) | Replace |
| Hour meter (par. 91) | Replace |
| Air heater (par. 92) | Replace |
| All switches (par. 93) | Replace |
| All lamps (par. 94) | Aline, service, or replace |
| All wires (par. 96) | Repair or replace |

HEAVY TRACTOR M1

NONELECTRICAL INSTRUMENTS

| | |
|------------------------------------|---------|
| Oil pressure gage (par. 97) | Replace |
| Fuel pressure gage (par. 98) | Replace |
| Temperature gage (par. 99) | Replace |
| Air pressure gage (par. 100) | Replace |
| Mile meter (par. 101) | Replace |

ELECTRIC AND AIR BRAKE SYSTEM

| | |
|--|--------------------|
| Air compressor assembly (par. 103) | Service or replace |
| Air brake controls (par. 103) | Replace |
| Electric brake controls (par. 104) | Replace |

MASTER CLUTCH

| | |
|---|----------------|
| Master clutch assembly (par. 108) | Adjust or wash |
|---|----------------|

STEERING CLUTCHES

| | |
|---|----------------|
| Steering clutches (pars. 112 and 113) | Adjust or wash |
|---|----------------|

TRACTOR BRAKES

| | |
|----------------------------------|--------|
| Steering brakes (par. 115) | Adjust |
|----------------------------------|--------|

FINAL DRIVE ASSEMBLY

| | |
|--|--------|
| Sprocket hub bearings (par. 118) | Adjust |
|--|--------|

TRACKS AND TRUCK FRAME ASSEMBLY

| | |
|---|--------------------|
| Front idlers (par. 120) | Service or replace |
| Track release assembly (par. 120) | Adjust |
| Truck wheels (par. 121) | Service or replace |
| Truck wheel guards (par. 121) | Replace |
| Track support rollers (par. 122) | Service or replace |
| Track shoe or plate | Replace |
| Pintle drawbar (par. 123) | Replace |
| Pintle bracket (par. 123) | Replace |

WINCH

| | |
|---------------------------------|---------|
| Winch assembly (par. 125) | Adjust |
| Winch cables (par. 125) | Replace |

MISCELLANEOUS

| | |
|---|--|
| Lubrication (pars. 27 to 32) | |
| Tractor cleaning (par. 44) | |
| Tractor painting (pars. 45 to 50) | |

d. In the following sections on maintenance of the tractor, specific mention is not always made of lock washers, cotter keys, and safety wire. It is to be understood that whenever these items are removed they are to be reinstalled or replaced at assembly.

Section X

STANDARD TOOLS AND EQUIPMENT

| | |
|------------------------------|------------------|
| | Paragraph |
| Equipment and location | 56 |
| Care of equipment | 57 |

56. EQUIPMENT AND LOCATION.

a. The items listed below are furnished as standard equipment with each tractor and are in tool boxes on the tractor.

| Equipment | Stowage Position |
|--|--------------------------------------|
| BLOCK, snatch (1) | In box |
| BOOK, model HD-10 instruction, (1) | In box |
| BOOK, model HD-10 parts, (1) | In box |
| CHAIN, tow (1) | In box |
| CLIP, for attaching seat back cushions (2) | In box |
| FULCRUM, valve lifter (used with valve lifter and injector remover tool) (1) | In tool box |
| GASKET, plug (2) | In box |
| GUN, hand grease, push type (1) | In box |
| GUN, pressure grease, with hose, lever type (1) | In box |
| HAMMER (1) | In tool box |
| KIT, injector service (1) includes: | In tool box |
| BRUSH, large (1) | GAGE, timing (1) |
| BRUSH, small (1) | STONE (1) |
| DRILL (1) | VISE, pin (1) |
| GAGE, feeler (1) | WIRE, probing (1) |
| KIT, wrench (1) includes: | In tool box |
| WRENCH, open-end, $\frac{7}{16}$ -in. | WRENCH, open-end, $\frac{5}{8}$ -in. |
| — $\frac{1}{2}$ -in. (1) | — $\frac{3}{4}$ -in. (1) |
| WRENCH, open-end, $\frac{9}{16}$ -in. | WRENCH, open-end, $\frac{7}{8}$ -in. |
| — $1\frac{1}{16}$ -in. (1) | — $1\frac{1}{16}$ -in. (1) |
| WRENCH, open-end, $1\frac{9}{32}$ -in. | WRENCH, open-end, 1-in. |
| — $2\frac{5}{32}$ -in. (1) | — $1\frac{1}{4}$ -in. (1) |
| LUBRICATOR, flushing, with hose (1) | In box |
| PLIERS (1) | In tool box |
| PLUG, pipe $\frac{1}{2}$ -in. std. (1) | In box |
| PREHEATER, engine (1) | In box |
| SCREW, cap, for attaching seat back cushions (4) | In box |
| SCREWDRIVER (1) | In tool box |
| TOOL, valve lifter and injector removal (1) | In tool box |
| WASHER, lock $\frac{3}{8}$ -in. for attaching seat back cushions (4) | In box |

HEAVY TRACTOR M1

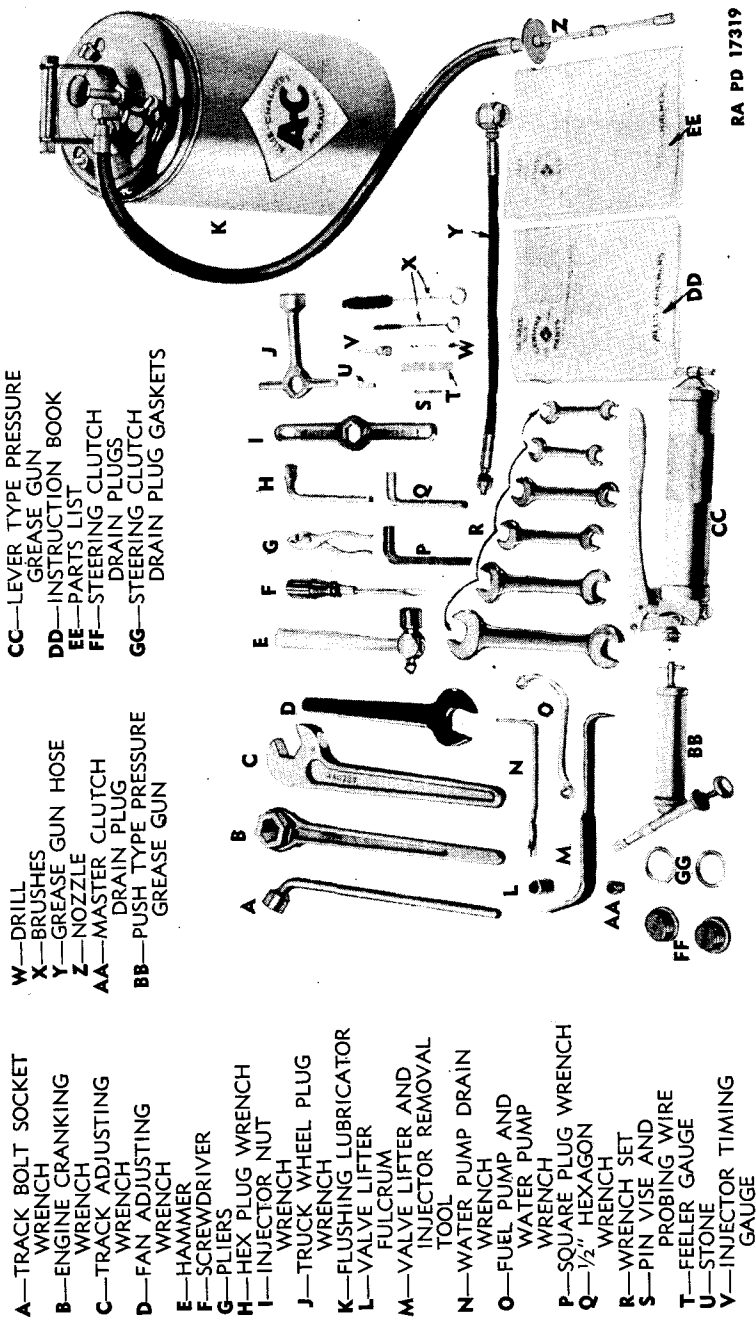

Figure 27 —Standard Tool Equipment

RA PD 17319

STANDARD TOOLS AND EQUIPMENT

| Equipment | Stowage Position |
|--|------------------|
| WRENCH, engine cranking (1) | In tool box |
| WRENCH, fan adjusting (1) | In tool box |
| WRENCH, fuel pump (1) | In tool box |
| WRENCH, hexagon, 1/2-in. (1) | In tool box |
| WRENCH, hexagon plug (1) | In tool box |
| WRENCH, injector nut (1) | In tool box |
| WRENCH, square plug (1) | In tool box |
| WRENCH, track bolt socket (1) | In tool box |
| WRENCH, track release adjusting (1) | In tool box |
| WRENCH, water drain (1) | In tool box |
| List of approved lubricating oils for use in positive seal assemblies, transmission, and final drives | In box |

57. CARE OF EQUIPMENT.

a. An accurate record of all tools and equipment should be kept in order that their location and condition may be known at all times. Items becoming lost or unserviceable should be immediately replaced. All tools and equipment should be cleaned and in proper condition for further use before being returned to their location.

HEAVY TRACTOR M1

Section XI

ENGINE

| | Paragraph |
|---|-----------|
| General description and data | 58 |
| Rocker arm assembly | 59 |
| Valve clearance | 60 |
| Governor | 61 |
| Exhaust manifold and muffler | 62 |
| Removal of engine from tractor | 63 |
| Installation of engine in tractor | 64 |

58. GENERAL DESCRIPTION AND DATA (figs. 28 to 32).

a. The engine in this tractor is a water-cooled, 2-cycle Diesel with two cylinders in line. This engine differs from the conventional 4-cycle

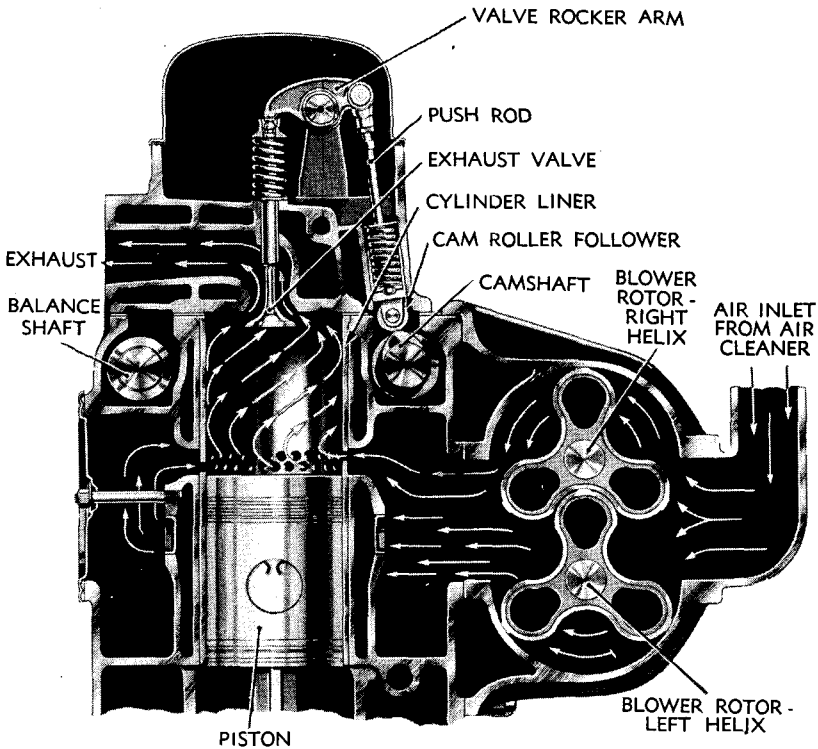

RA PD 56398

Figure 28—Cross Section of Engine Showing Circulation of Air

ENGINE

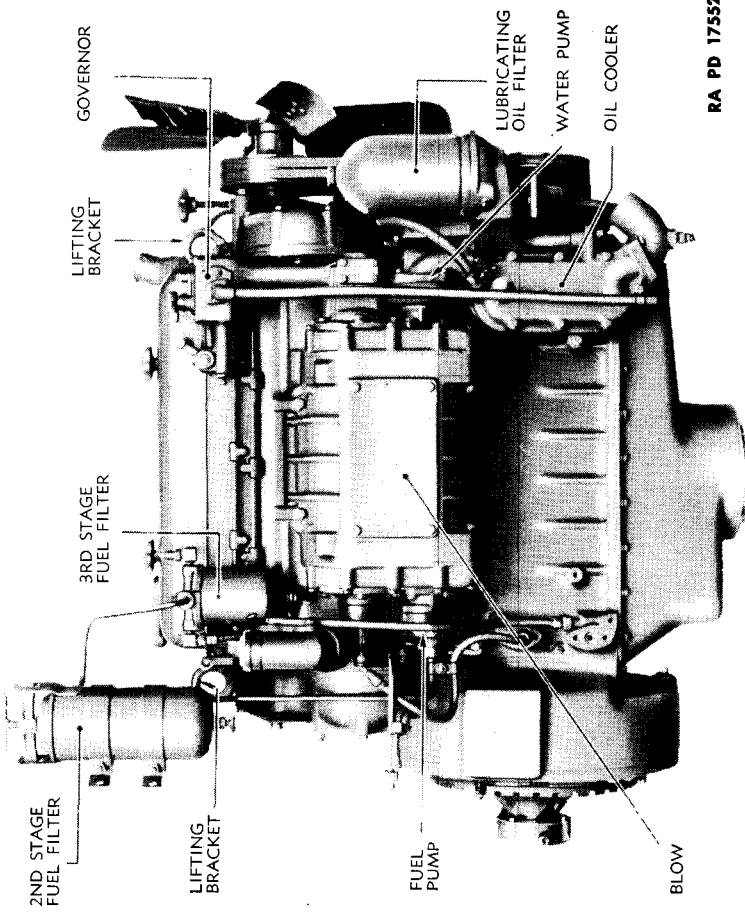

RA PD 17552

Figure 29—Engine—Right Side

HEAVY TRACTOR M1

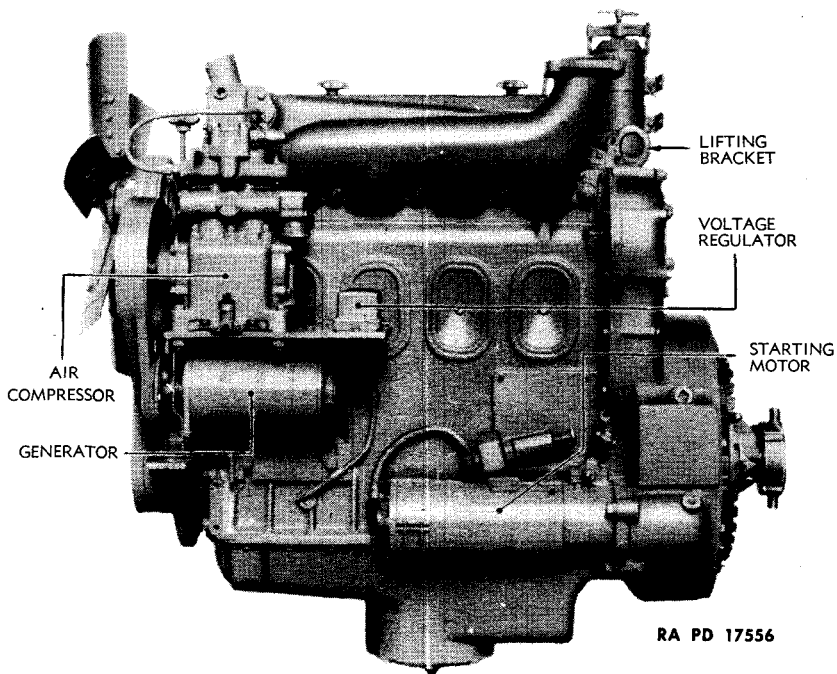

RA PD 17556

Figure 30—Engine—Left Side

engine in that it requires only two strokes of the piston, one up and one down, to complete an operating cycle instead of four strokes as in the 4-cycle engine. In the 2-cycle engine, intake and exhaust occur together when the piston is at the bottom of its stroke; every upstroke is a compression stroke; every downstroke delivers power. Thus the intake and exhaust strokes of the 4-cycle engine are eliminated. The 2-cycle engine exhausts burned gases and fills its cylinders with fresh air, not by the pumping action of the engine itself, but by means of a rotary blower mounted on the right side of the engine and driven from the engine crankshaft. As the piston nears the end of its power stroke, the exhaust valves (two for each cylinder) in the cylinder head open to allow the burned gases to escape and the piston uncovers the intake ports in the lower part of the cylinder wall (64 holes in each cylinder liner) to permit fresh air from the blower to rush in, forcing burned gases out through the exhaust valves and filling the cylinder with a new charge of fresh air (fig. 28). As the piston rises on the compression stroke, it closes off the intake ports, the exhaust valves close, and the charge of air is compressed into one-sixteenth of its former volume. This compression causes the air to become extremely hot. A charge of

ENGINE

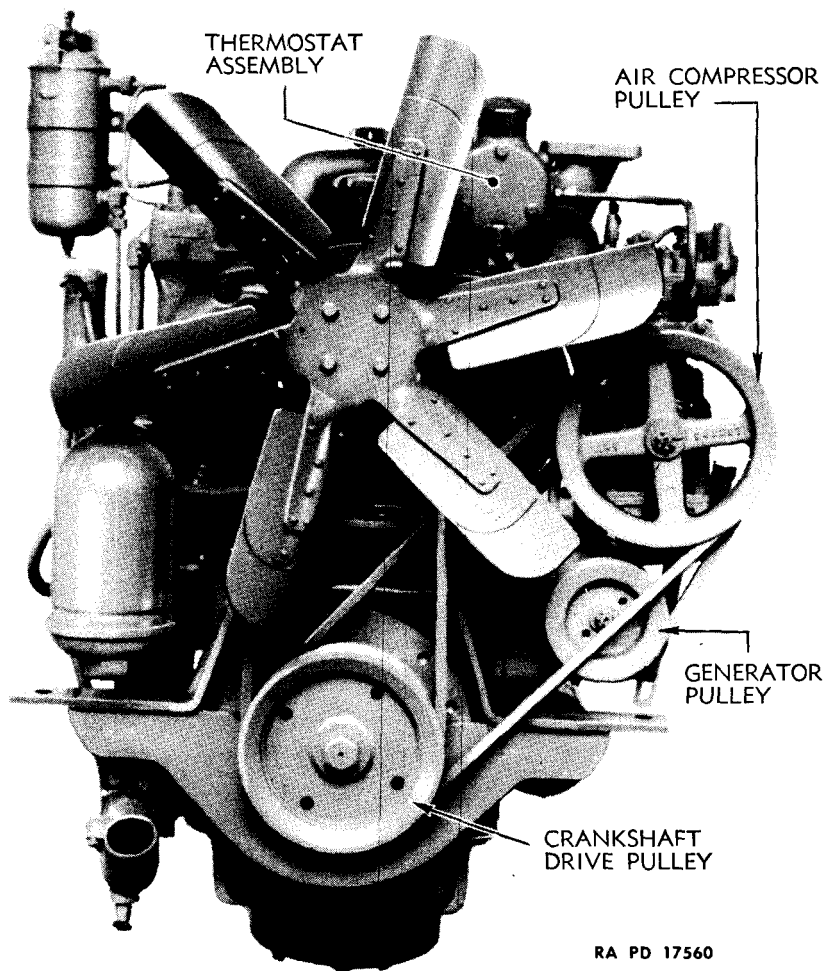

RA PD 17560

Figure 31—Engine—Front View

Diesel fuel is injected into this hot compressed air by the injector, just before the piston reaches the top of its stroke. The fuel is ignited by the hot air and burns, and the expansion caused by the combustion of the gases formed forces the piston down on its power stroke.

b. Basic engine parts are readily accessible. On the right-hand side, as viewed from the operator's seat, are located the blower, engine governor, fuel pump, second and third stage fuel filters, lubricating oil filter and cooler, and water pump. The air compressor, starter, air heater, and generator are mounted on the left-hand side.

HEAVY TRACTOR M1

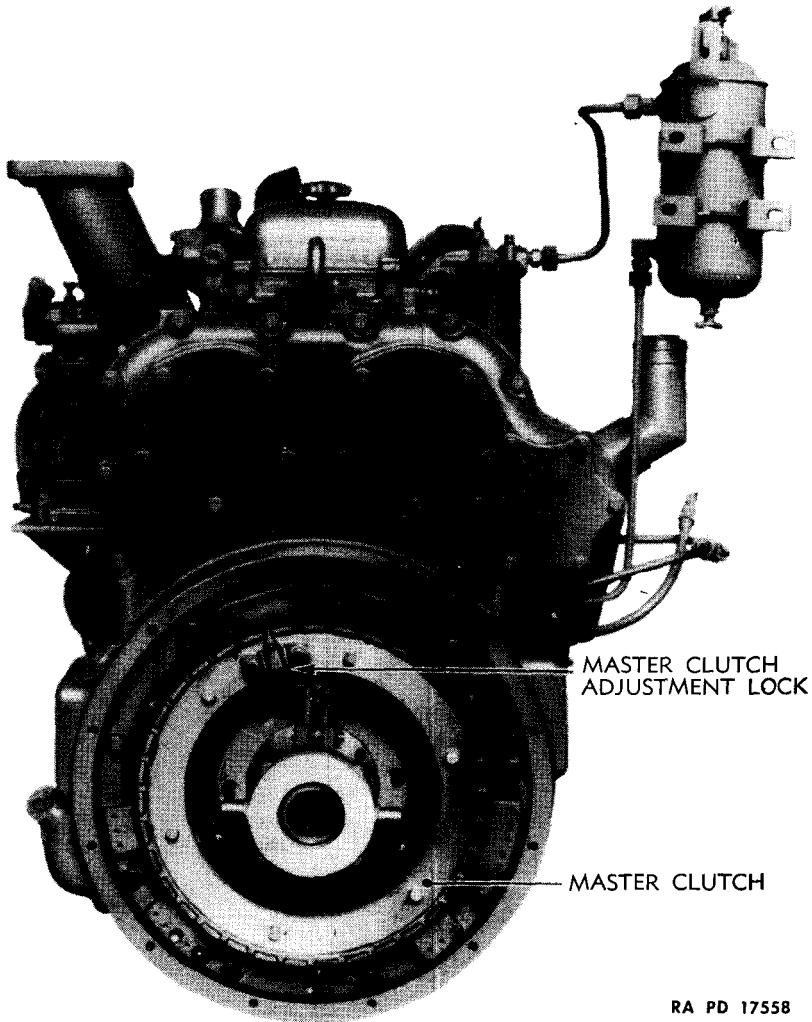

RA PD 17558

Figure 32—Engine—Rear View

c. The fuel pump and water pump are driven by the lower blower rotor shaft. The fan and air compressor are driven by V-belts from a pulley on the crankshaft, and the generator is driven by a V-belt from the air compressor pulley.

d. The flywheel housing and timing gear cover are bolted directly to the rear end of the cylinder block. Lifter brackets are provided, attached to the top of the cylinder head. These are used in the removal or installation of the engine.

ENGINE

e. Tabulated Data.

| | |
|--|--------------------------|
| Make of engine | General Motors 4-71 RC14 |
| Weight with accessories, dry (approx.) | 1,865 lb |
| At 2,000 rpm maximum horsepower (engine alone) | 110.0 |
| At 1,750 rpm | 105.0 |
| Number of cylinders | 4 |
| Bore and stroke | 4¼ x 5 in. |
| Piston displacement | 284 cu. in. |
| Compression ratio | 16 to 1 |
| Number of exhaust valves per cylinder | 2 |
| Firing order, clockwise rotation (cranking) | 1-3-4-2 |
| Crankcase capacity | 13 qt |

Direction of rotation (viewed from operator's seat):

| | |
|----------------|------------------|
| Crankshaft | Counterclockwise |
| Starter | Clockwise |
| Generator | Counterclockwise |
| Fuel pump | Clockwise |
| Water pump | Clockwise |
| Oil pump | Counterclockwise |
| Blower | Counterclockwise |
| Air compressor | Counterclockwise |

Ratio of accessory drive to crankshaft speed:

| | | |
|----------------|-------|------|
| Starter | 9.27 | to 1 |
| Generator | 1.7 | to 1 |
| Fuel pump | 1.94 | to 1 |
| Water pump | 1.94 | to 1 |
| Oil pump | 1.39 | to 1 |
| Blower | 1.94 | to 1 |
| Air compressor | 0.933 | to 1 |

f. Trouble Shooting.

(1) UNEVEN RUNNING, EXCESSIVE VIBRATION OF ENGINE.

| <i>Probable Cause</i> | <i>Probable Remedy</i> |
|----------------------------------|--|
| Insufficient fuel supply. | Check fuel supply and filters (pars. 66 and 68). |
| Injectors out of time. | Time injectors (par. 70). |
| Injectors not equalized. | Equalize injectors (par. 70). |
| Valves out of adjustment. | Adjust valve clearance (par. 60). |
| Broken valve spring. | Notify ordnance personnel. |
| One or more cylinders misfiring. | Inspect fuel supply (par. 66). |
| Air leaks in fuel system. | Inspect for loose connections (par. 71). |

HEAVY TRACTOR M1

Probable Cause

Clogged fuel filters.
 Fuel lines cracked.
 Surging governor.

Probable Remedy

Replace filter elements (par. 68).
 Replace lines (par. 71).
 Bring engine up to operating temperature; check for binding in governor linkage.

(2) ENGINE RUNS HOT.

Insufficient cooling water supply.
 Radiator tubes clogged.
 Rotted hoses.
 Radiator fins clogged.

 Fan belts loose or broken.
 Water pump inoperative.
 Thermostat stuck in closed position.
 Lack of oil pressure.
 Carbon accumulation in engine.
 Radiator shutter closed.

Check water in radiator.
 Clean radiator (par. 77).
 Replace hoses (par. 79).
 Blow chaff, etc., out of fins (par. 77).
 Adjust or replace (par. 80).
 Replace water pump (par. 75).
 Replace (par. 78).

 Notify ordnance personnel.
 Notify ordnance personnel.
 Open shutter.

(3) LOSS OF POWER.

Insufficient fuel.
 Injectors out of time.
 Injectors not equalized.
 Governor out of adjustment.
 Butterfly valve out of adjustment.
 Air cleaner plugged.
 Port holes in cylinder liners plugged.
 Burned valves.
 Defective fuel pump.

Check fuel system.
 Time injectors (par. 70).
 Equalize injectors (par. 70).
 Notify ordnance personnel.
 Notify ordnance personnel.
 Clean air cleaner (par. 73).
 Notify ordnance personnel.

 Notify ordnance personnel.
 Replace (par. 69).

(4) BLACK SMOKE FROM EXHAUST.

Poor grade of fuel.
 Air cleaner improperly serviced.
 Muffler plugged.
 Hand hole cover loose or gaskets blown.
 Precleaners plugged.
 Port holes in cylinder liners clogged.
 Air box drain tube plugged.
 Injectors out of time.

Change to better fuel.
 Check air cleaners (par. 73).
 Replace muffler (par. 62).
 Tighten cover or replace gasket.

 Remove and clean (par. 72).
 Notify ordnance personnel.

 Remove and clean.
 Time injectors (par. 70).

ENGINE

| Probable Cause | Probable Remedy |
|---------------------------|-----------------------------------|
| Injectors not equalized. | Equalize injectors (par. 70). |
| Defective injector. | Replace injector (par. 70). |
| Valves out of adjustment. | Adjust valve clearance (par. 60). |
| Poor compression. | Notify ordnance personnel. |

(5) BLUE SMOKE FROM EXHAUST.

| | |
|--|--------------------------------------|
| Insufficient fuel to injectors. | Check fuel system (pars. 66 and 68). |
| Lubricating oil entering combustion chamber. | Notify ordnance personnel. |
| Injectors not equalized. | Equalize injectors (par. 70). |

(6) ENGINE DETONATES (KNOCKS).

| | |
|--|-----------------------------------|
| Injectors out of time. | Time injectors (par. 70). |
| Injectors not equalized. | Equalize injectors (par. 70). |
| Faulty injector. | Replace injector (par. 70). |
| Damaged main or connecting rod bearings. | Notify ordnance personnel. |
| Incorrect valve clearance. | Adjust valve clearance (par. 60). |
| Lubricating oil entering combustion chamber. | Notify ordnance personnel. |

59. ROCKER ARM ASSEMBLY.

a. General. There are three rocker arms for each cylinder. The two outer arms operate the exhaust valves and the center rocker arm operates the injector. The three rocker arms for each cylinder operate on a single shaft, supported by two brackets. A special 1/2-inch hollow cap screw holds each bracket to the cylinder head. The removal of these two cap screws permits the brackets to be removed from the shaft and the shaft to be removed from the rocker arms. The rocker arms may then be laid back, giving access to the injector and valve assemblies. The rocker arm assemblies may be replaced by the using arm personnel if they are broken or worn.

b. Removal of Rocker Arm Assembly.

WRENCH, open-end, 7/16-in. (2) WRENCH, open-end, 9/16-in.
WRENCH, open-end, 1/2-in. WRENCH, socket, 3/4-in.

(1) REMOVE PRECLEANERS AND HOOD. Refer to paragraph 70 d and figures 61 and 62.

(2) REMOVE ROCKER ARM COVER. Unscrew the two hand screws holding rocker arm cover to cylinder head and lift off cover.

HEAVY TRACTOR M1

(3) LOOSEN PUSH ROD LOCK NUTS.

WRENCH, open-end, 1/2-in.

Loosen nuts underneath clevis on push rods.

(4) REMOVE INJECTOR FUEL LINES.

WRENCH, open-end, 1/2-in.

Remove the fuel line connectors at both ends of injector fuel lines and remove lines. Place shipping caps on fittings from which lines were removed.

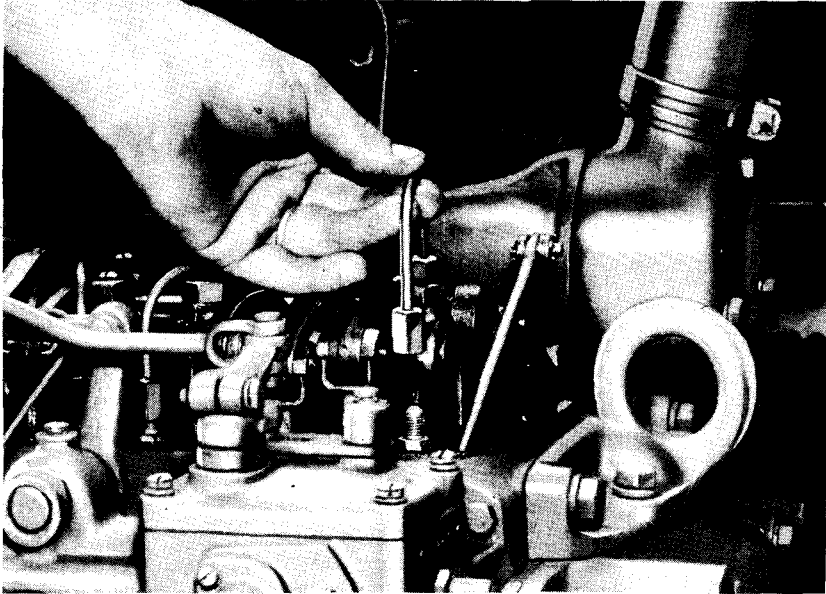

RA PD 17606

Figure 33—Injector Fuel Line Removed

(5) REMOVE ROCKER SHAFT BRACKETS.

WRENCH, socket, 3/4-in.

Remove the two cap screws holding the rocker arm assembly to cylinder head and remove brackets.

(6) REMOVE SHAFT. Remove shaft by sliding it out of rocker arms.

(7) REMOVE ROCKER ARM ASSEMBLIES. Unscrew push rods from clevises and remove rocker arms.

c. Installation.

GAGE, feeler

GAGE, injector timing

SCREWDRIVER

WRENCH, open-end, 1/4-in.

WRENCH, open-end, 1/2-in.

WRENCH, socket, 3/4-in.

ENGINE

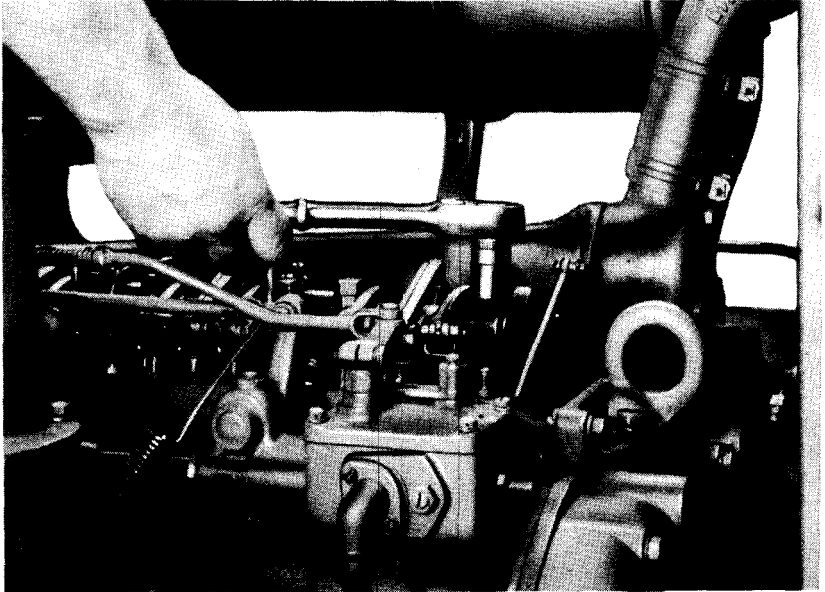

RA PD 17619

Figure 34—Removing Cap Screws from Rocker Arm Brackets

(1) **INSTALL ROCKER ARMS ON PUSH RODS.** Screw the push rods into the rocker arm clevis so that the end of the rod is flush with the top of the threaded part of the clevis. **NOTE:** This is very important because of the small clearance between the valve head and the top of the piston when the piston is at the top of its stroke. It is possible for the piston to strike the head of the valve, resulting in considerable damage, if rocker arm is not screwed down far enough. The injector rocker arm has a hardened ball stud and ball seat which form a universal joint.

(2) **SLIDE SHAFT THROUGH ROCKER ARMS.** If the original shaft is used, turn the side having the greatest evidence of wear up.

(3) **INSTALL BRACKETS.**

WRENCH, socket, $\frac{3}{4}$ -in.

Place the brackets on the shaft, smooth side towards rocker arms, and draw the long cap screws down firmly. As the brackets are tightened down, hold the brackets together, allowing only slight clearance between the rocker arms and brackets. A total of 0.003-inch to 0.006-inch clearance is sufficient.

(4) **INSTALL THE INJECTOR FUEL LINES.**

WRENCH, open-end, $\frac{1}{2}$ -in.

Remove the shipping caps and install the fuel lines.

HEAVY TRACTOR M1

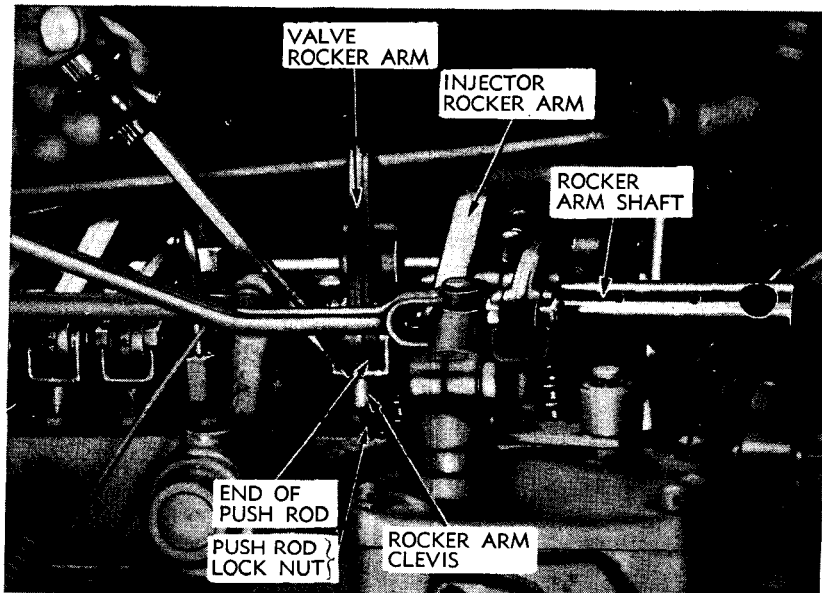

RA PD 56464

Figure 35—Installing Rocker Arm

(5) ADJUST VALVE CLEARANCE AND TIMING AND EQUALIZE INJECTOR. See paragraph 60 for valve clearance adjustment, and paragraph 70 for injector timing and equalizing.

60. VALVE CLEARANCE.

a. **General.** Correct valve clearance is important because of high compression pressure developed in a Diesel engine. Too little clearance causes a loss of compression, "missing," and eventual burning of the valves and valve seats. Too much clearance results in noisy engine operation. The correct valve clearance is 0.010-inch at operating temperature. The valve clearance is adjusted by turning the push rod in the rocker arm clevis, which changes the length of the rod. Turn the push rod to the left to decrease valve clearance (lengthen rod), and to the right to increase clearance (shorten rod). Follow the steps outlined below to set the valve clearance correctly.

b. Adjustment.

GAGE, feeler

WRENCH, open-end, 1/2-in.

WRENCH, open-end, 5/16-in.

(1) ROTATE ENGINE UNTIL INJECTOR IS AT BOTTOM OF STROKE. Rotate the engine with the starting motor until the injector plunger is fully depressed (injector rocker arm down).

ENGINE

- (2) ADJUST CLEARANCE BETWEEN ROCKER ARM AND PUSH ROD.
GAGE, feeler
WRENCH, open-end, $\frac{1}{2}$ -in.
WRENCH, open-end, $\frac{5}{16}$ -in.

Use the 0.010-inch feeler gage and adjust each push rod until the gage will just pass between the valve stem and the rocker arm.

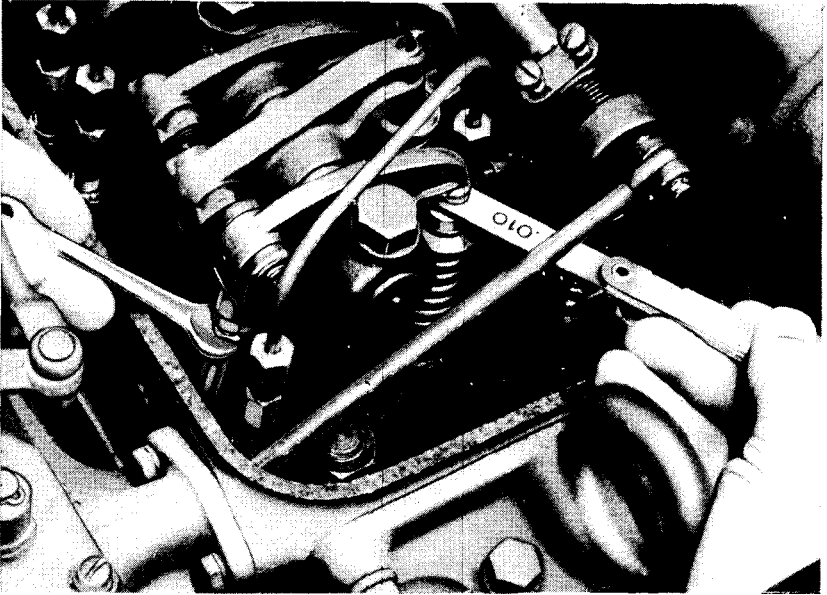

RA PD 17491

Figure 36—Valve Clearance Adjustment

- (3) TIGHTEN LOCK NUT.

WRENCH, open-end, $\frac{5}{16}$ -in. WRENCH, open-end, $\frac{1}{2}$ -in.

Hold push rod and tighten lock nut. Check again to see if 0.010-inch feeler gage can be inserted between the valve stem and rocker arm. A slight drag should be felt on feeler gage.

- (4) Repeat above steps for each cylinder.

61. GOVERNOR.

a. **Description.** The governor is of the mechanical, flyball or fly-weight type. Its purpose is to control engine idling speed and to limit maximum engine speed under the variable load requirements.

b. Many governors are adjusted unnecessarily because of failure to realize that, while irregularities in engine performance may result from faulty governors, they more often are due to other causes. A governor, when correctly adjusted, will seldom require attention.

HEAVY TRACTOR M1

c. The using arm personnel should not attempt any adjustment or replacement of the governor. All other possible causes of irregular engine performance should be eliminated first, and if the governor is still suspected as the cause, report it to the ordnance personnel.

62. EXHAUST MANIFOLD AND MUFFLER.

a. **Description.** The exhaust manifold is in one section and is held to the cylinder head by five $\frac{7}{16}$ -inch studs, nuts, and special washers. The muffler is bolted to the manifold with four $\frac{1}{2}$ -inch cap screws and lock washers and supported at each end by supports from the cylinder block end plates. There is also a muffler support strap between the exhaust manifold and the muffler.

b. Trouble Shooting.

(1) LOUD EXHAUST.

| Probable Cause | Probable Remedy |
|--------------------|-------------------|
| Gasket blown. | Replace gasket. |
| Holes in muffler. | Replace muffler. |
| Break in manifold. | Replace manifold. |
| Broken supports. | Replace supports. |

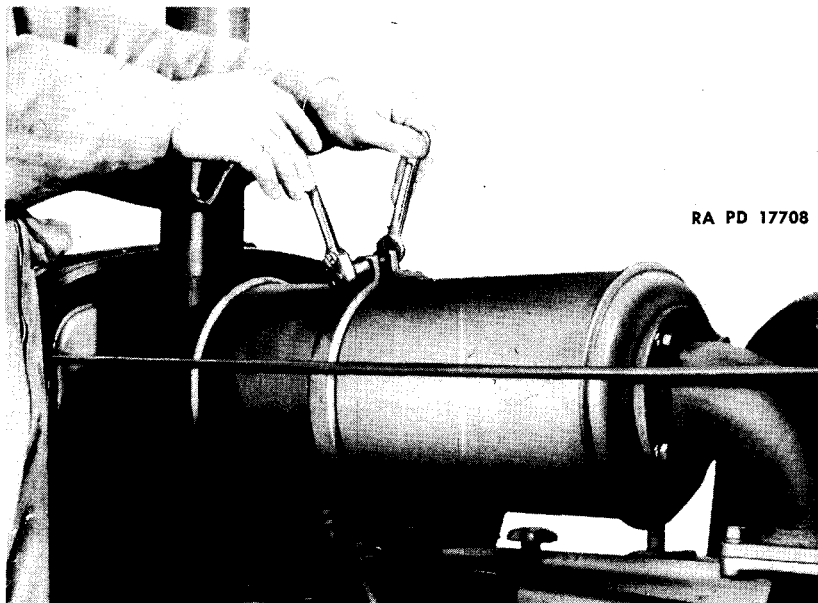

Figure 37—Removing Bolts from Muffler Clamp

ENGINE

c. Removal.

WRENCH, open-end, $\frac{9}{16}$ -in.

WRENCH, socket, $\frac{9}{16}$ -in.

WRENCH, socket, $\frac{5}{8}$ -in.

WRENCH, socket, $\frac{3}{4}$ -in. with extension

(1) REMOVE MUFFLER CLAMP.

WRENCH, open-end, $\frac{9}{16}$ -in.

WRENCH, socket, $\frac{9}{16}$ -in.

Remove the four bolts from clamp around muffler.

(2) REMOVE MUFFLER.

WRENCH, socket, $\frac{9}{16}$ -in.

WRENCH, socket, $\frac{3}{4}$ -in.

Remove the two cap screws holding muffler to front support, two cap screws holding stack elbow to muffler, and the four cap screws holding muffler and elbow to rear support and manifold, and remove muffler.

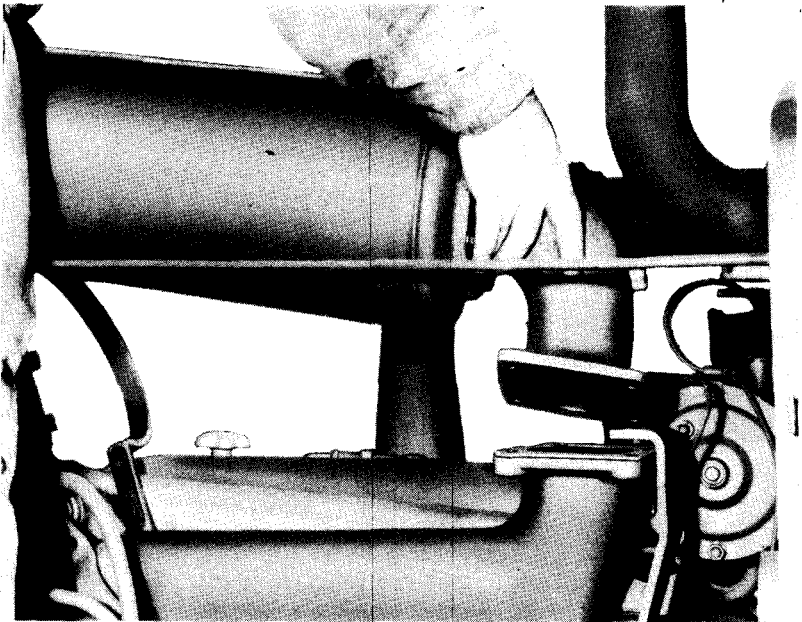

RA PD 17710

Figure 38—Removing Muffler

(3) REMOVE MANIFOLD.

WRENCH, socket, $\frac{5}{8}$ -in. with extension

Loosen the nuts on stud bolts holding manifold to cylinder head and lift manifold off the studs.

(4) REMOVE MUFFLER SUPPORTS.

WRENCH, open-end, $\frac{9}{16}$ -in.

WRENCH, socket, $\frac{9}{16}$ -in.

Remove the cap screws and nuts from bolts holding supports to

HEAVY TRACTOR M1

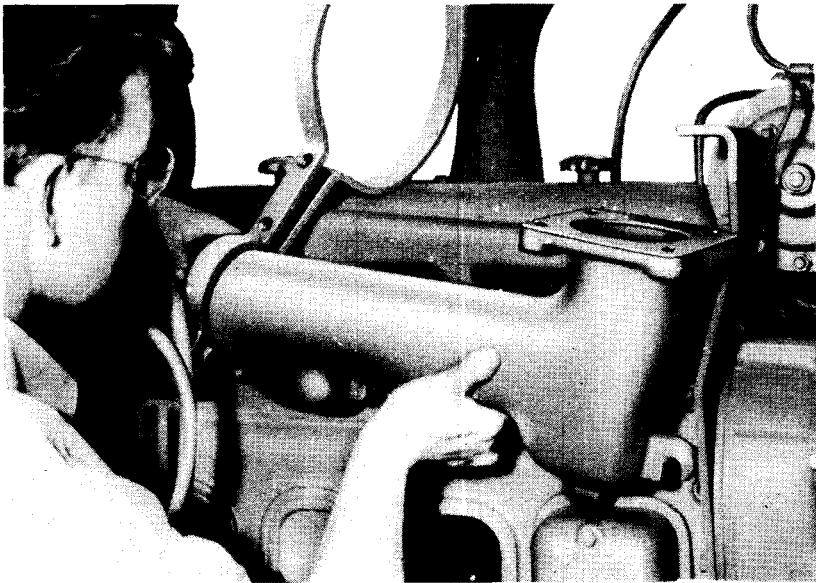

RA PD 17712

Figure 39—Removing Exhaust Manifold

cylinder block end plates, and remove supports. NOTE: Because the heat to which cap screws in the muffler are subjected causes them to “seize” in the threads, it is advisable to leave the muffler supports attached to the muffler and manifold, unless repair or replacement of some of the parts is necessary. Remove the cap screws and nuts on bolts holding the supports to the cylinder block end plate and remove the muffler, exhaust manifold and supports as a unit.

d. Installation.

WRENCH, open-end, $\frac{9}{16}$ -in.

WRENCH, socket, $\frac{9}{16}$ -in.

WRENCH, socket, $\frac{5}{8}$ -in.

WRENCH, socket, $\frac{3}{4}$ -in., with extension

(1) **INSTALL MANIFOLD.** Clean all old gaskets off manifold and head. Remove the nuts and washers from stud bolts in head and place new gaskets on studs. Shellac or grease is unnecessary. Place manifold on studs and tighten all nuts *evenly*.

(2) **INSTALL MUFFLER SUPPORTS.** Put supports in place and install bolts, cap screws, and lock washers, but do not tighten nuts or cap screws.

ENGINE

(3) INSTALL MUFFLER.

WRENCH, socket, $\frac{1}{16}$ -in. WRENCH, socket, $\frac{3}{4}$ -in.

Start cap screws with lock washers through front support and back support and manifold.

(4) TIGHTEN ALL BOLTS.

WRENCH, socket, $\frac{1}{16}$ -in. WRENCH, socket, $\frac{3}{4}$ -in.

Tighten cap screws bolting muffler bracket to manifold, first. Then, tighten all cap screws and nuts in muffler supports.

(5) INSTALL MUFFLER CLAMP.

WRENCH, socket, $\frac{1}{16}$ -in.

Place clamp around muffler body and manifold, install bolts, lock washers, and nuts, and tighten.

63. REMOVAL OF ENGINE FROM TRACTOR.

a. Equipment.

| | |
|--------------------------------|--|
| CHAIN HOIST | WRENCH, box, $\frac{1}{16}$ -in. with 90 deg offset |
| HAMMER, 2-lb | WRENCH, open-end, $\frac{3}{8}$ -in. |
| PLIERS | WRENCH, open-end, $\frac{7}{16}$ -in. |
| PUNCH, large | (2) |
| PUNCH, small | WRENCH, open-end, $\frac{1}{16}$ -in. |
| ROPE | WRENCH, open-end, $\frac{5}{8}$ -in. |
| SCREWDRIVER, 10-in. | WRENCH, open-end, $\frac{11}{16}$ -in. |
| WRENCH, $\frac{1}{2}$ -in. | WRENCH, open-end, $\frac{7}{8}$ -in. |
| WRENCH, $\frac{3}{4}$ -in. (2) | WRENCH, socket, $\frac{5}{8}$ -in. |
| WRENCH, $1\frac{5}{16}$ -in. | |
| WRENCH, 1-in. | |

b. Procedure.

(1) **DRAIN COOLING SYSTEM.** Open drain cocks in lower connector elbow and water pump.

(2) REMOVE PRECLEANERS AND HOOD.

WRENCH, $\frac{7}{16}$ -in. (2) WRENCH, open-end, $\frac{1}{16}$ -in.

Loosen clamp bolts ($\frac{7}{16}$ -in. wrenches) and lift precleaners off pre-cleaner extension tubes. Loosen bolts at each corner of hood ($\frac{1}{16}$ -in. wrench), pry bolts out of clips and lift hood off over exhaust tail pipe and precleaner elbows (figs. 61 and 62).

(3) REMOVE BOTH FRONT FENDERS.

WRENCH, $\frac{3}{4}$ -in. (2)

Remove four bolts in right fender and three bolts and one cap screw in left fender and remove fenders (fig. 74).

HEAVY TRACTOR M1

(4) REMOVE WINCH DRIVE SHAFT GUARD AND GUARD SUPPORT BRACKET.

WRENCH, $\frac{9}{16}$ -in.

WRENCH, 1-in.

WRENCH, $\frac{3}{4}$ -in. (2)

Remove winch drive shaft guard by removing the three bolts at rear of guard ($\frac{3}{4}$ -in. wrenches) and three cap screws at front ($\frac{9}{16}$ -in. wrench). Remove the two cap screws holding bracket to radiator shell (1-in. wrench) and then remove bracket. Remove the two corresponding cap screws on right side holding radiator shell to engine support.

(5) DISCONNECT WIRES AND UPPER RADIATOR HOSE.

SCREWDRIVER, 10-in. .

Disconnect ground terminal from battery post. Disconnect headlight wires at connector. This connector can be found near generator. Loosen lower clamp of top radiator hose and remove hose from thermostat housing.

(6) REMOVE ENGINE SUPPORT BOTTOM COVER.

WRENCH, $\frac{7}{8}$ -in.

Remove the six cap screws holding cover to engine support. It may be necessary to pry cover from support (fig. 88).

(7) DISCONNECT LOWER WATER CONNECTION.

WRENCH, $\frac{1}{2}$ -in.

Remove the two cap screws holding connection to oil cooler inlet.

(8) REMOVE RADIATOR GRILLE.

CHAIN HOIST

WRENCH, 1-in.

HAMMER, 2-lb

WRENCH, socket, $\frac{5}{8}$ -in. with

PUNCH, large

6-in. extension

ROPE

Remove the four nuts on each side from bolts holding grille to radiator ($\frac{5}{8}$ -in. wrench). Loosen the two remaining cap screws holding radiator shell to engine support (1-in. wrench) and tilt top of radiator back until radiator touches fan. Drive out the T-head bolts from which nuts were removed (hammer, punch), taking care not to damage threads, and lift out grille (rope, chain hoist). NOTE: The lower bolts on left-hand side should be removed last, as grille will have to be shifted to the left to allow this bolt to pass under flange on winch drum.

(9) REMOVE FAN ASSEMBLY.

PLIERS

WRENCH, $\frac{3}{4}$ -in.

Remove pin from radiator shutter control rod (pliers) and pull top of radiator as far forward as possible. Remove the three cap screws holding bracket of fan assembly (fig. 81) to balance weight cover of engine ($\frac{3}{4}$ -in. wrench), remove belts from pulley and lift out fan assembly. Disengage shutter control rod, as radiator is lifted out.

ENGINE

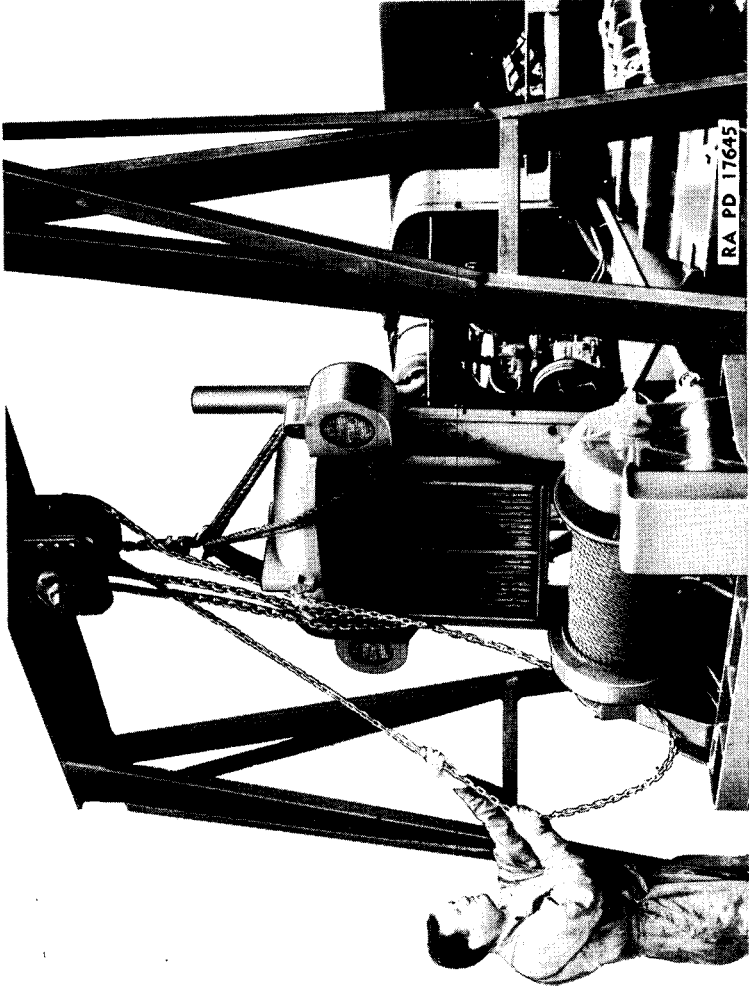
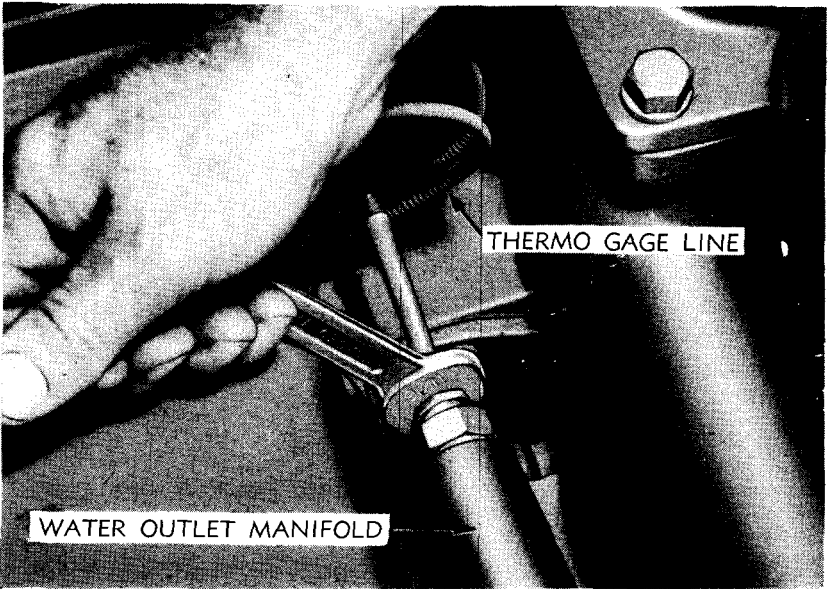

Figure 40 — Lifting Out Radiator Assembly

ENGINE



RA PD 56393

Figure 41—Removing Thermo Gage Tube from Water Outlet Manifold

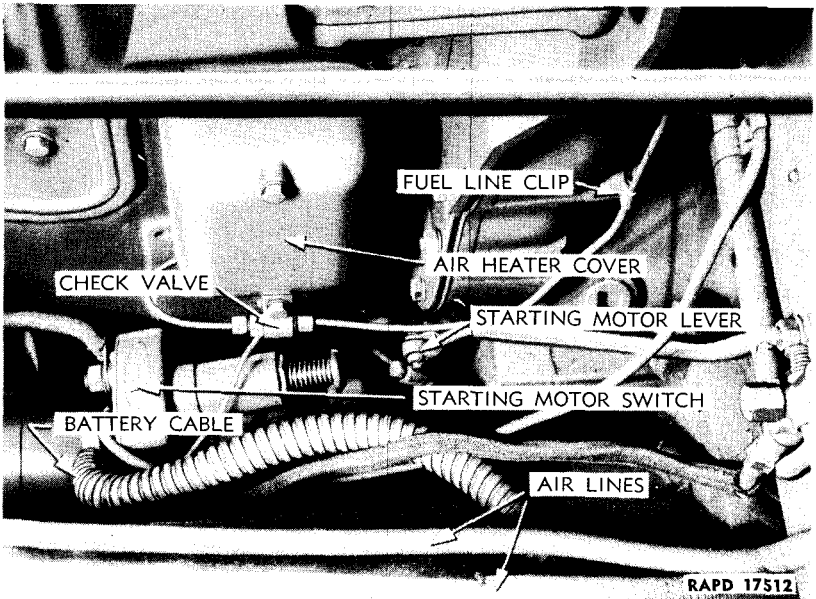

RAPD 17512

Figure 42—View Showing Wires, Lines, and Controls to Be Disconnected

HEAVY TRACTOR M1

remove cover, disconnect wire from bottom of coil ($\frac{3}{8}$ -in. wrench) and reinstall cover ($\frac{1}{2}$ -in. wrench).

(17) DISCONNECT STARTING MOTOR.

PLIERS

WRENCH, $\frac{3}{4}$ -in.

Disconnect battery cable from starting motor switch terminal. Tape end of battery cable to prevent its contacting metal. Lift ammeter and electric trailer brake control wire from terminal. Disconnect the starting motor control rod by removing cotter pin and pin (pliers) from the starter lever.

(18) DISCONNECT WIRE FROM VOLTAGE REGULATOR.

SCREWDRIVER, 10-in.

Disconnect wire running from voltage regulator to ammeter.

(19) REMOVE AIR LINES.

WRENCH, $\frac{7}{16}$ -in.

WRENCH, open-end, $\frac{5}{8}$ -in.

WRENCH, $\frac{1}{2}$ -in.

WRENCH, open-end, $\frac{7}{8}$ -in.

Disconnect the two air lines from fittings on top of air compressor ($\frac{5}{8}$ -in. and $\frac{7}{8}$ -in. wrenches) and remove bolts from clip holding lines to air compressor bracket ($\frac{7}{16}$ -in. and $\frac{1}{2}$ -in. wrenches).

(20) ENGAGE MASTER CLUTCH. The master clutch must be engaged so that throw-out bearing will clear clutch shaft when engine is moved ahead to be lifted out of tractor.

(21) REMOVE CLUTCH INSPECTION HOLE COVER.

PLIERS

WRENCH, $\frac{3}{4}$ -in.

Remove two cap screws and lift off floor plate over inspection hole cover ($\frac{3}{4}$ -in. wrench). Remove four cap screws from cover over master clutch inspection hole ($\frac{3}{4}$ -in. wrench). Remove cover, pull cotter pin (pliers) and remove yoke pin from end of master clutch control rod (fig. 114).

(22) REMOVE NUT FROM RELEASE BEARING LUBRICATING TUBE.

WRENCH, $1\frac{5}{16}$ -in.

Remove nut from lubricating tube on top of clutch housing and push grease tube down into clutch compartment. Prevent tube from turning or twisting while removing nut (fig. 43).

(23) DISCONNECT ENGINE FROM SPACER.

PUNCH, small

**WRENCH, box, $\frac{9}{16}$ -in., with
90 deg offset**

Remove the ten cap screws holding engine to spacer. **NOTE:** The two bottom cap screws may be most easily removed with a 90-degree offset, box socket wrench. The offset wrench can be placed between the flywheel housing and equalizer spring to remove the cap screws. Turn wrench with punch through opposite end of wrench.

ENGINE

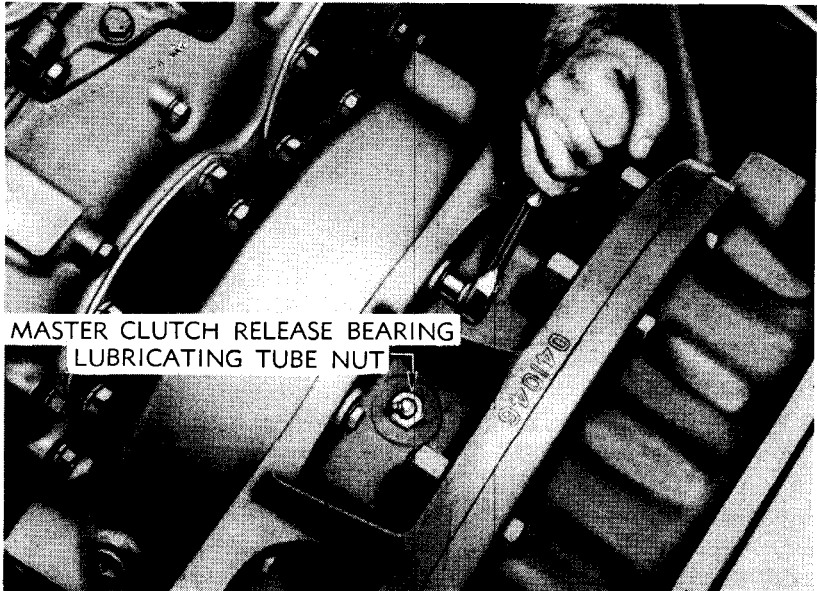

MASTER CLUTCH RELEASE BEARING
LUBRICATING TUBE NUT

RA PD 56394

Figure 43—View Showing Location of Engine-to-Spacer Cap Screws

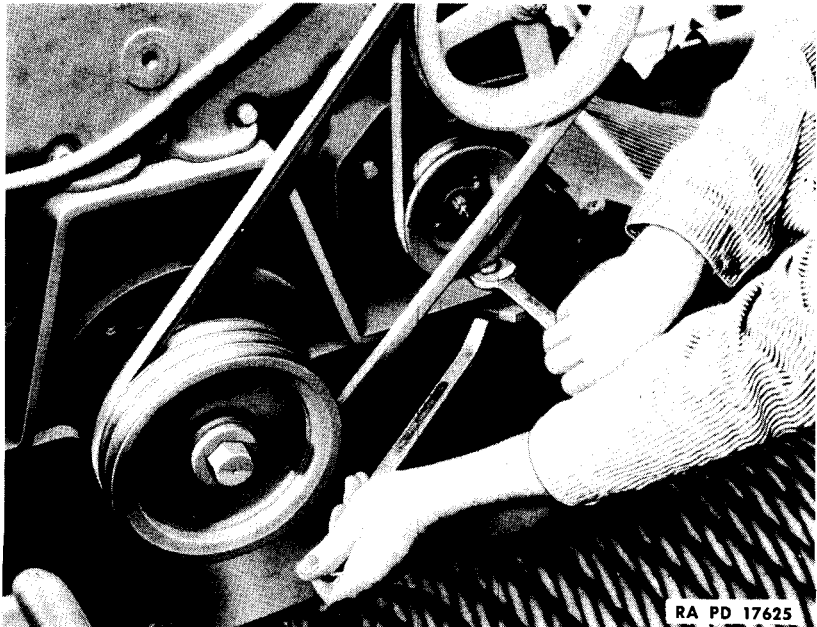

RA PD 17625

Figure 44—Removing Bolts from Front Engine Hanger

HEAVY TRACTOR M1

(24) REMOVE BOLTS FROM FRONT ENGINE HANGER.

WRENCH, $\frac{7}{8}$ -in.

WRENCH, $1\frac{5}{16}$ -in.

Remove the two bolts from the front engine hanger ($\frac{7}{8}$ -in. and $1\frac{5}{16}$ -in. wrenches), lift motor slightly, and take out the shims from between support and hanger.

(25) LIFT ENGINE FROM TRACTOR.

CHAIN HOIST

ROPE

Engine can now be removed by a chain hoist and rope connected to lifter brackets. Raise engine high enough to take weight off engine supports; then slide engine forward far enough so that master clutch throw-out bearing clears end of clutch shaft. Engine may then be lifted from tractor.

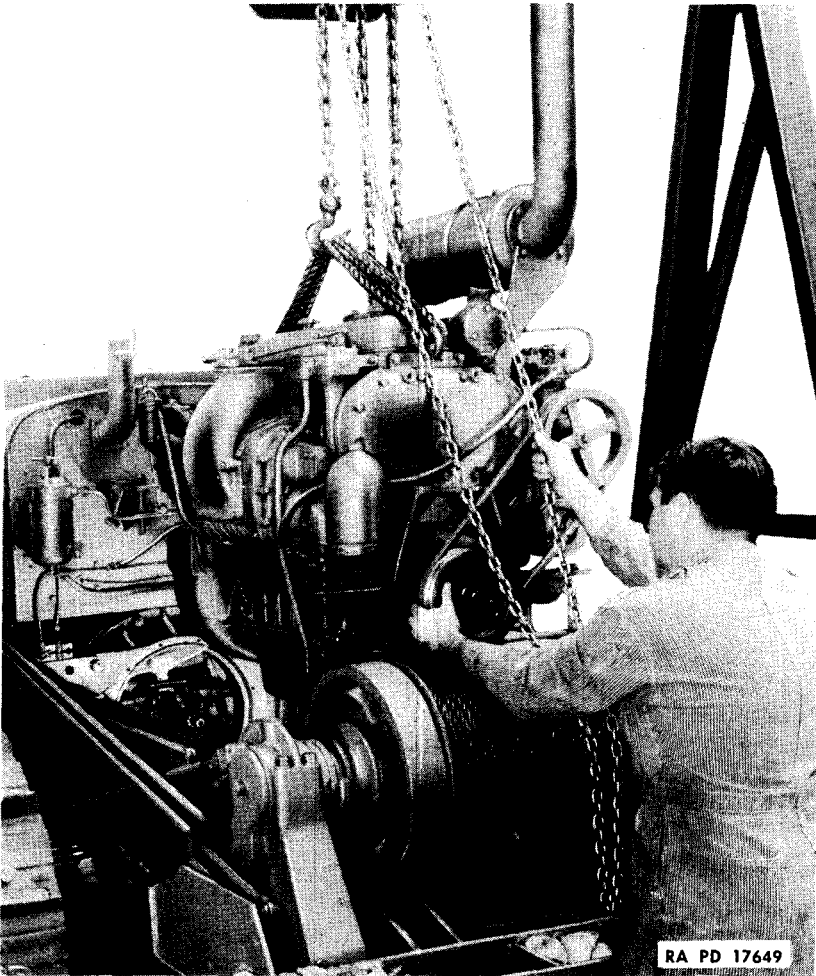

RA PD 17649

Figure 45—Lifting Engine from Tractor

ENGINE

64. INSTALLATION OF ENGINE IN TRACTOR.

a. Before installing engine back into tractor, wash dirt and grease from the engine support and master clutch compartment. At the same time, inspect the engine support assembly, engine spacer, and master clutch compartment and assemblies included in them, and if any repair work is necessary on them, do it before engine is installed. Check engine spacer and engine support bolts to see that all are tight and none missing. Check bolts holding winch assembly to engine support, tighten or replace them if necessary. Also inspect wiring and fuel lines on tractor for necessary repairs or replacement.

b. Equipment.

| | |
|--|---|
| BAR, pry | WRENCH, open-end, $\frac{3}{8}$ -in. |
| CHAIN HOIST | WRENCH, open-end, $\frac{7}{16}$ -in. |
| GAGE, injector timing | WRENCH, open-end, $\frac{1}{2}$ -in. |
| PLIERS | WRENCH, open-end, $\frac{9}{16}$ -in. |
| ROPE | (2) |
| SCALE or RULER | WRENCH, open-end, $\frac{5}{8}$ -in. |
| SCREWDRIVER, 8-in. | WRENCH, open-end, $1\frac{1}{16}$ -in. |
| SCREWDRIVER, 10-in. | WRENCH, open-end, $\frac{3}{4}$ -in. |
| WRENCH, 1-in. | WRENCH, open-end, $\frac{7}{8}$ -in. |
| WRENCH, box socket, $\frac{9}{16}$ -in., with 90 deg offset | WRENCH, open-end, $1\frac{5}{16}$ -in. |
| WRENCH, engine cranking | WRENCH, socket, $\frac{9}{16}$ -in. |
| WRENCH, fan adjusting | WRENCH, socket, $\frac{5}{8}$ -in., with 6-in. extension |
| WRENCH, open-end, $\frac{5}{16}$ -in. | WRENCH, socket, $\frac{3}{4}$ -in. |

c. Procedure.

(1) LOWER ENGINE INTO PLACE.

CHAIN HOIST

ROPE

NOTE: Master clutch must be engaged in order to install engine. Using chain hoist and rope, lower engine into position until the hole in clutch release bearing carrier lines up with end of clutch shaft. Start engine back onto shaft.

(2) LINE UP SPLINES.

WRENCH, engine cranking

Line up the splines on the clutch shaft with the splines in driven member of master clutch. Crankshaft will have to be turned to do this, using cranking wrench. Line up sliding blocks on release bearing carrier with slots in throw-out yoke. Push engine back until sliding blocks engage yoke and clutch shaft enters driven member hub.

(3) CONNECT ENGINE TO SPACER.

WRENCH, box socket, $\frac{9}{16}$ -in.,
with 90 deg offset

WRENCH, socket, $\frac{9}{16}$ -in.

HEAVY TRACTOR M1

Start the ten $\frac{3}{8}$ - x 2-inch cap screws with lock washers holding flywheel housing to engine spacer (two $\frac{9}{16}$ -in. wrenches). Tighten them securely before removing chain hoist and chain.

(4) INSTALL SHIMS UNDER FRONT ENGINE HANGER.

CHAIN HOIST

WRENCH, $\frac{7}{8}$ -in.

ROPE

WRENCH, $1\frac{5}{16}$ -in.

Use shims taken out when engine was removed. Crowd as many shims as possible without raising front of engine between front engine hanger end and engine support. Then, raise front of engine with chain hoist and add one more shim to each side (shims are $\frac{1}{32}$ -in. thick). Install the two $\frac{5}{8}$ - x 2-inch bolts with lock washers holding engine hanger and shims to engine support bracket (fig. 44).

(5) CONNECT RELEASE BEARING LUBRICATING TUBE.

WRENCH, open-end, $1\frac{1}{16}$ -in.

WRENCH, open-end, $1\frac{5}{16}$ -in.

Insert release bearing lubricating tube through hole in spacer and secure with $\frac{5}{8}$ -inch jam nut (fig. 43).

(6) CONNECT INNER CLUTCH ROD.

PLIERS

Connect inner clutch rod to sublever with pin and cotter pin.

(7) ADJUST MASTER CLUTCH AND CLUTCH BRAKE.

BAR, pry

WRENCH, $\frac{9}{16}$ -in.

PLIERS

WRENCH, $\frac{3}{4}$ -in. (2)

SCALE or RULER

Refer to section XVIII.

(8) INSTALL MASTER CLUTCH INSPECTION COVER.

WRENCH, socket, $\frac{3}{4}$ -in.

Install master clutch inspection cover and gasket with four $\frac{1}{2}$ - x $1\frac{1}{4}$ -inch cap screws with lock washers.

(9) INSTALL AIR INTAKE ELBOW.

SCREWDRIVER, 10-in.

WRENCH, $\frac{9}{16}$ -in.

Remove large cloth from blower intake. Install air intake elbow and gasket to top of air intake housing with four $\frac{3}{8}$ - x 1-inch cap screws and lock washers ($\frac{9}{16}$ -in. wrench). Slide hose coupling into position on air cleaner outlet pipe and tighten clamps (screwdriver).

(10) CONNECT CONTROL ROD.

PLIERS

Connect shut-off bell crank to air shutter shaft lever rod by installing yoke pin and cotter pin connecting the rod to the air shutter shaft lever. Connect shut-off bell crank to governor rod by installing yoke pin and cotter pin connecting the rod to the governor.

HEAVY TRACTOR M1**(18) INSTALL THERMO GAGE TUBE.****WRENCH**, open-end, $1\frac{1}{16}$ -in.

Install thermo gage tube in rear of water manifold and tighten jam nut (fig. 41).

(19) LOWER RADIATOR INTO POSITION.**CHAIN HOIST****WRENCH**, 1-in.**ROPE**

Lower radiator assembly into position on front of engine support. Start the two front lower $\frac{3}{4}$ - x $1\frac{3}{4}$ -inch cap screws with lock washers holding radiator to engine support, but do not tighten. Remove chain hoist and rope.

(20) INSTALL FAN ASSEMBLY AND CONNECT RADIATOR SHUTTER CONTROL ROD.**PLIERS****WRENCH**, fan adjusting**WRENCH**, $\frac{3}{4}$ -in.

Tilt radiator forward, lay belts in fan pulley and install fan assembly on balance weight cover with three $\frac{1}{2}$ - x $2\frac{1}{4}$ -inch cap screws with lock washers ($\frac{3}{4}$ -in. wrench). Adjust belts so one side of belt can be depressed 1 inch between pulley ($\frac{3}{4}$ -in. wrench and fan adjusting wrench). Install pin through control rod and radiator shutter lever and secure with cotter pin (pliers).

(21) INSTALL RADIATOR GRILLE.**HAMMER**, 2-lb**WRENCH**, socket, $\frac{5}{8}$ -in., with**PUNCH**, long

6-in. extension

Tilt radiator back until it touches fan. Set grille in position and install the eight T-head bolts with lock washers holding radiator grille to shell (punch, hammer, $\frac{5}{8}$ -in. wrench). Install lower left-hand bolt first as grille will have to be shifted to the left so that this bolt will pass flange of winch drum.

(22) CONNECT TOP RADIATOR HOSE. Shellac lower end of hose and place over thermostat housing outlet. Fasten clamp.

(23) INSTALL CAP SCREWS HOLDING RADIATOR,**WRENCH**, 1-in.

Install the two remaining $\frac{3}{4}$ - x $1\frac{3}{4}$ -inch cap screws with lock washers on right side of radiator. Do not tighten.

(24) INSTALL WINCH DRIVE SHAFT GUARD BRACKET.**SCREWDRIVER**, 10-in.**WRENCH**, 1-in.

Install bracket in position and install two $\frac{3}{4}$ - x 2-inch cap screws with lock washers through it into engine support on left side of radiator. Tighten radiator bolts on both sides (1-in. wrench). Tighten hose clamps on top hose (screwdriver).

ENGINE**(25) INSTALL LOWER WATER CONNECTION.****WRENCH**, 1/2-in.

Shellac new gasket to oil cooler inlet and install lower water connection with two 5/16- x 1-inch cap screws with lock washers.

(26) INSTALL ENGINE SUPPORT COVER.**WRENCH**, 7/8-in.

Install engine support bottom cover and secure with six 5/8- x 1 1/2-inch cap screws with lock washers. See that crankcase drain plug is tight in place.

(27) CONNECT HEADLIGHT WIRES. Connect headlight wires at connector near generator.

(28) FILL COOLING SYSTEM. Close drain cocks and fill cooling system with water, or, if it is below freezing, antifreeze solution. Remove pipe plug in thermostat housing while filling system. Install plug when water runs out the hole and finish filling radiator.

(29) FILL ENGINE AND AIR COMPRESSOR CRANKCASES WITH OIL. Fill engine crankcase to "FULL" mark on oil level bayonet gage with OIL, engine, seasonal grade (13 qt). Fill air compressor crankcase to level of filler plug with engine oil. See lubrication charts for specifications (sec. IV).

(30) EQUALIZE INJECTORS.**GAGE**, injector timing**WRENCH**, open-end, 1/2-in.**WRENCH**, open-end, 5/16-in.

Injectors must be equalized at this time. Remove rocker arm cover, if it has been installed, and follow procedure outlined in paragraph 70.

(31) INSTALL FRONT FENDERS.**WRENCH**, 3/4-in. (2)

Install right fender with four 1/2- x 1 1/4-inch bolts with lock washers. Install left fender with three 1/2- x 1 1/4-inch bolts and one cap screw with lock washer. Tighten bolts and cap screws.

(32) INSTALL WINCH DRIVE SHAFT GUARD.**WRENCH**, 5/16-in. (2)**WRENCH**, 3/4-in. (2)

Place winch drive shaft guard in place. Install three 3/8- x 1-inch cap screws with lock washers holding guard to front bracket (5/16-in. wrench). Install two 3/8- x 1 1/4-inch bolts (two 5/16-in. wrenches) and one 1/2- x 1 1/4-inch bolt with lock washers (two 3/4-in. wrenches) holding rear end of guard to left rear fender.

(33) START ENGINE. Open fuel shut-off cock under tank. Fasten ground terminal connection to battery post. Check all wires, fuel lines, and controls to be sure they are all connected and tight, and start engine.

HEAVY TRACTOR M1

It is advisable to fill the second and third stage fuel filters to save cranking the engine with starting motor for fuel pump to fill them, although it is not necessary. After engine starts, check all fuel, oil, and water connections and fuel and oil filters for leaks. Observe fuel and lubricating oil pressure gages to see that they are registering the correct pressures.

(34) INSTALL HOOD.

WRENCH, open-end, $\frac{9}{16}$ -in.

Install hood over precleaner elbows and exhaust tail pipe, insert corner hold-down bolts in clips, and tighten bolts.

(35) INSTALL PRECLEANERS.

WRENCH, $\frac{7}{16}$ -in. (2)

Install precleaners on air intake elbows and tighten clamp bolts.

Section XII

FUEL AND AIR SYSTEM

| | Paragraph |
|----------------------------------|-----------|
| General | 65 |
| Fuel supply tank | 66 |
| Sediment sumps | 67 |
| Fuel filters | 68 |
| Fuel pump | 69 |
| Injectors | 70 |
| Fuel lines and connections | 71 |
| Precleaners | 72 |
| Air cleaner | 73 |

65. GENERAL.

a. The fuel system consists of a fuel tank, sediment sumps, fuel pump, fuel filters, fuel lines and injectors. The 156-gallon supply tank is equipped with sediment sumps, drains, and a fuel shut-off valve. The first stage, or primary filter assembly, consists of two filters, exactly alike, mounted on a bracket bolted to the transmission case. There are also two other filters: the second stage filter, fastened on the front of the cowl, and the third stage filter, bolted to the engine. The fuel pump is

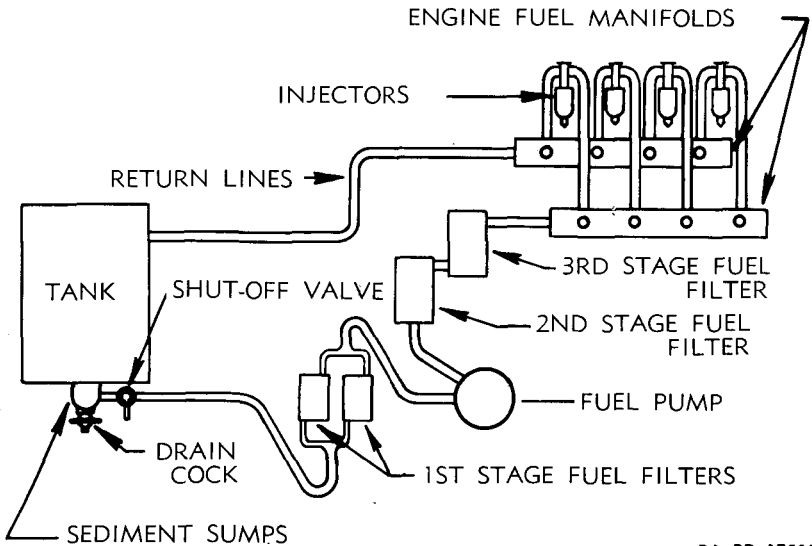

RA PD 17515

Figure 46—Fuel System Diagram

HEAVY TRACTOR M1

bolted to the rear of the blower and is driven by the lower blower rotor shaft.

b. The fuel is drawn from the bottom of the fuel tank and through the first stage filters by the fuel pump. The fuel is then forced, under about 25 pounds pressure, through the second and third stage filters to the lower fuel manifold on the side of the cylinder head. From this manifold the fuel flows, under pressure, to the injectors, through a porous bronze filter located in the injector. The surplus fuel leaves the injector through a similar porous bronze filter and returns through the return or upper fuel manifold and fuel return line to the fuel tank. This continual circulation of fuel oil helps to cool the injectors, warms up the fuel, and eliminates air pockets in the fuel system.

66. FUEL SUPPLY TANK.

a. **Description.** The fuel tank is located at the rear of the tractor and has a capacity of 156 U. S. standard gallons. Care should be taken, when filling the tank with fuel, that all hoses, funnels, or containers used are *clean* to prevent dirt from entering and clogging the fuel lines and filters.

b. Two sediment sumps on the bottom of the tank (fig. 24) are provided to allow the operator to drain out, with a minimum waste of fuel, the dirt and water which settles to the bottom. Dirt and water will settle out of the fuel into these sumps and can be drained out. Drain cocks on these sumps should be opened daily, preferably after the tractor has stood for an hour or more, or overnight. In freezing weather, it is doubly important to drain the water from the sediment sumps and filters to prevent freezing and damage due to freezing.

c. **Maintenance.** The tank should be drained and flushed out periodically with clean fuel oil whenever an accumulation of rust or dirt is evident. To do this, the tractor should be on level ground. Remove the two sediment sumps from the tank and pour about 10 gallons of clean fuel oil into the tank and let it drain out, flushing the dirt and rust with it. If a pressure fuel hose is available, flushing may be done by inserting the hose through the holes in the bottom of the tank where the sediment sumps were removed. Use new gaskets and shellac both sides of gasket when installing the sediment sumps back on the tank.

67. SEDIMENT SUMPS.

a. The purpose of the sediment sumps (fig. 24) has been explained in paragraphs 66 b and c.

b. **Removal.**

CONTAINERS, fuel

WRENCH, socket, $\frac{9}{16}$ -in., with extension

FUEL AND AIR SYSTEM

- (1) **DRAIN TANK.** Drain fuel from tank into clean containers.
- (2) **REMOVE SUMPS.** Remove three cap screws and lock washers from each unit and remove the sediment sumps.
- (3) **CLEAN OFF OLD GASKETS.** Clean old gaskets off fuel tank before installing new sediment sumps.

c. Installation.

SHELLAC

WRENCH, socket, $\frac{9}{16}$ -in., with extension

- (1) **SHELLAC NEW GASKETS TO SUMPS.**

SHELLAC

WRENCH, socket, $\frac{9}{16}$ -in., with extension

- (2) **INSTALL SUMPS.** Install sumps with cap screws and lock washers.

68. FUEL FILTERS.

a. **General.** The circulation of fuel oil through the injectors in this engine helps keep the injectors cool. The fuel pump circulates approximately 25 gallons of fuel per hour through the injection system.

If this quantity is allowed to decrease and get too low, there is a possibility of serious damage to the injectors because of overheating. As the fuel filters begin to plug up, the quantity of fuel circulating through the injectors becomes less. It may be reduced to the point where the injectors are becoming dangerously overheated, even though this flow may be sufficient to keep the engine operating normally. Therefore, proper performance of the engine does *not* necessarily mean that enough fuel is being circulated. For this reason, the fuel filtering system should be checked and the filter elements replaced, if necessary, at the first indication of any deviation from normal fuel oil pressure. All fuel filters are of the replaceable element type. A good indication as to about how often it will be necessary to replace filter elements will be given by the length of time the first two or three elements used operate satisfactorily. That is, if the filters plug up on an average of every 400 hours for the first two or three times, the fuel filters should be changed, as an item of routine service, every 400 hours of operation thereafter, without waiting for a drop in fuel pressure. The length of time that the fuel filter elements will operate, depends upon the type and kind of fuel oil being used and also on how clean the fuel oil is kept. Change the filter elements in the fuel filters after a reasonable

HEAVY TRACTOR M1

pressure is not within this range. When pressure drops to below 20, proceed as follows:

(a) Drain sediment sump under fuel tank of all water and sediment.

(b) Remove both first stage fuel filter elements and test fuel line from the tank to these filters to be absolutely sure that it is free and open. If necessary, replace the first stage filter elements with new ones. When installing them, make certain that the filter and gasket are in their proper place to prevent leakage. When starting engine after replacing this filter, it may be necessary to open drain at bottom of filter to allow air to escape before fuel will start to circulate through fuel system.

(c) Start engine and check to see whether fuel oil pressure comes up to normal. If not, stop the engine and replace element in second stage filter. Check fuel lines for obstructions and leaks and again start engine to determine whether fuel oil pressure comes up to normal.

(d) If fuel oil pressure is still below normal, replace element in third stage fuel filter. If all fuel line connections are tight, eliminating all possibility of air leaks, and pressure still does not come up to normal after above procedure, the fuel pump will have to be removed for repair or rebuilding and a new pump installed.

(2) If the fuel pressure is within the normal range and the operation of engine indicates that insufficient fuel is being supplied to the injectors, proceed as follows to locate the trouble:

(a) Check for obstructions in fuel lines and fuel manifold carrying fuel to the injectors. Also see that return fuel manifold and return fuel line to tank are not restricted in any way. To check the return flow, remove fuel tank cap and look into tank. When the engine is idling, there should be an ample flow of fuel into the tank from the return line.

(b) If no restriction is found in any part of fuel system as outlined in step (1) in this paragraph, it is likely that the porous bronze filters in the injectors are plugged, and the injectors will have to be removed.

(c) Replace, time, and equalize the injectors.

(d) Adjust exhaust valve clearance (pars. 60 and 70).

c. First Stage Filter Assembly.

(1) **DESCRIPTION.** The first stage filter assembly consists of two individual filters suspended on a bracket bolted to the transmission case. A fuel line from the supply tank leads to this assembly and another leads from the assembly to the fuel pump. Cotton-wound elements are used in these filters.

FUEL AND AIR SYSTEM

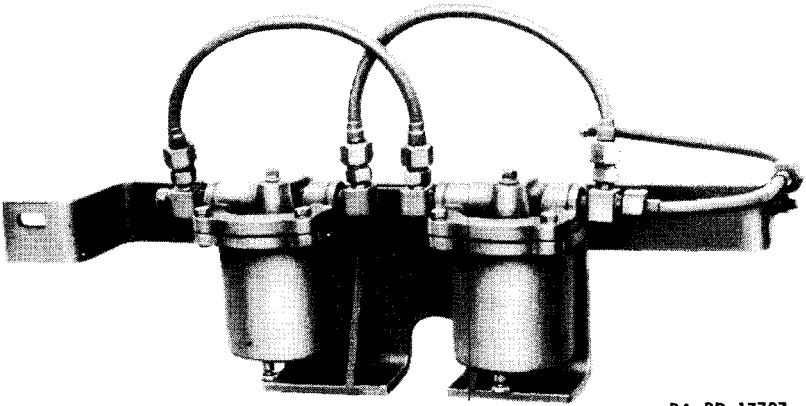

RA PD 17707

Figure 47—First Stage Filter Assembly

(2) REMOVAL.

WRENCH, open-end, $\frac{7}{8}$ -in.

(a) Disconnect Fuel Lines.

WRENCH, open-end, $\frac{7}{8}$ -in.

Close fuel shut-off valve at tank and disconnect the fuel lines from both inlet and outlet side of filter assembly.

(b) Remove Assembly from Tractor.

WRENCH, open-end, $\frac{7}{8}$ -in.

Remove the two cap screws holding bracket to tractor transmission case and remove assembly.

(3) DISASSEMBLY.

WRENCH, open-end, $\frac{9}{16}$ -in.

WRENCH, socket, $\frac{7}{16}$ -in.

WRENCH, open-end, $\frac{7}{8}$ -in.

WRENCH, socket, $\frac{9}{16}$ -in.

HEAVY TRACTOR M1

(a) Remove Filter Cups.

WRENCH, socket, $\frac{7}{16}$ -in.

Remove the four cap screws from each filter head and remove filter cups.

(b) Remove Filters from Bracket.

WRENCH, open-end, $\frac{9}{16}$ -in.

WRENCH, socket, $\frac{9}{16}$ -in.

WRENCH, open-end, $\frac{7}{8}$ -in.

Disconnect flexible fuel lines from filters, remove the two bolts holding each filter to bracket and remove filters from bracket.

(4) MAINTENANCE. Remove the dirty or clogged element and clean cup thoroughly with clean fuel oil. Replace old element with new one. NOTE: Do not attempt to clean dirty or clogged elements. It is not necessary to remove the entire assembly to replace filter elements. The element can be changed by merely removing the filter cups from the two filter heads of the assembly, leaving balance of assembly installed.

(5) REASSEMBLY.

WRENCH, open-end, $\frac{7}{16}$ -in.

WRENCH, open-end, $\frac{7}{8}$ -in.

WRENCH, open-end, $\frac{9}{16}$ -in.

WRENCH, socket, $\frac{9}{16}$ -in.

(a). Install Filter Heads.

WRENCH, open-end, $\frac{9}{16}$ -in.

WRENCH, socket, $\frac{9}{16}$ -in.

Clamp bracket in vise, if vise is available, and install filter clamp rings to bracket with two bolts each.

(b) Install Filter Cups.

WRENCH, socket, $\frac{7}{16}$ -in.

Bolt the cups to the filter heads with four cap screws, each using new gaskets. Shellac both sides of gaskets.

(c) Connect Fuel Lines Between Filters.

WRENCH, open-end, $\frac{7}{8}$ -in.

Place connectors of the flexible fuel lines on fittings, as shown in figure 47, and tighten them.

(6) INSTALLATION.

WRENCH, open-end, $\frac{7}{8}$ -in.

(a) Install Assembly on Tractor.

WRENCH, open-end, $\frac{7}{8}$ -in.

Install the assembly on the transmission case with the two cap screws.

(b) Connect Fuel Lines to Filter Assembly.

WRENCH, open-end, $\frac{7}{8}$ -in.

Connect the fuel lines to each end fitting of filter assembly; open fuel shut-off valve under fuel supply tank and inspect for leaks.

d. Second Stage Fuel Filter.

(1) DESCRIPTION. This filter is located in front of the cowl and held in two mounting bands bolted to cowl.

FUEL AND AIR SYSTEM

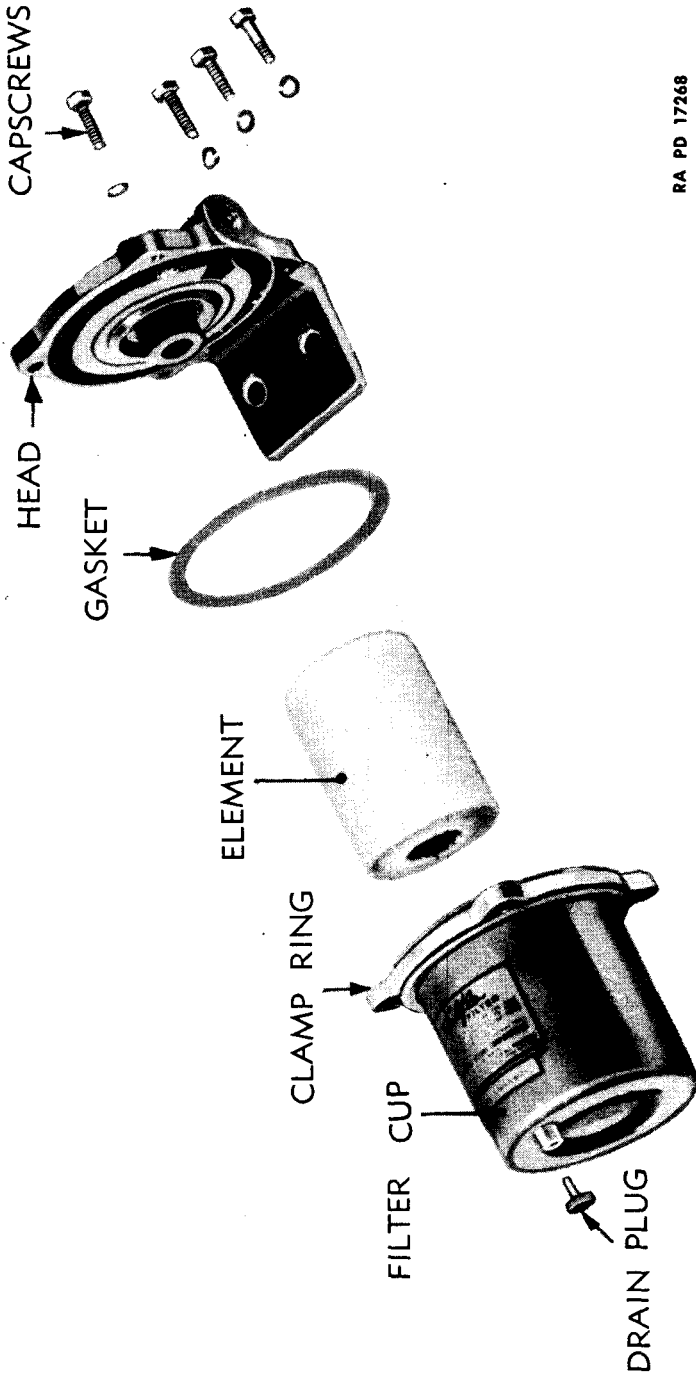

RA PD 17268

Figure 48—First Stage Filter Assembly—Exploded View

HEAVY TRACTOR M1

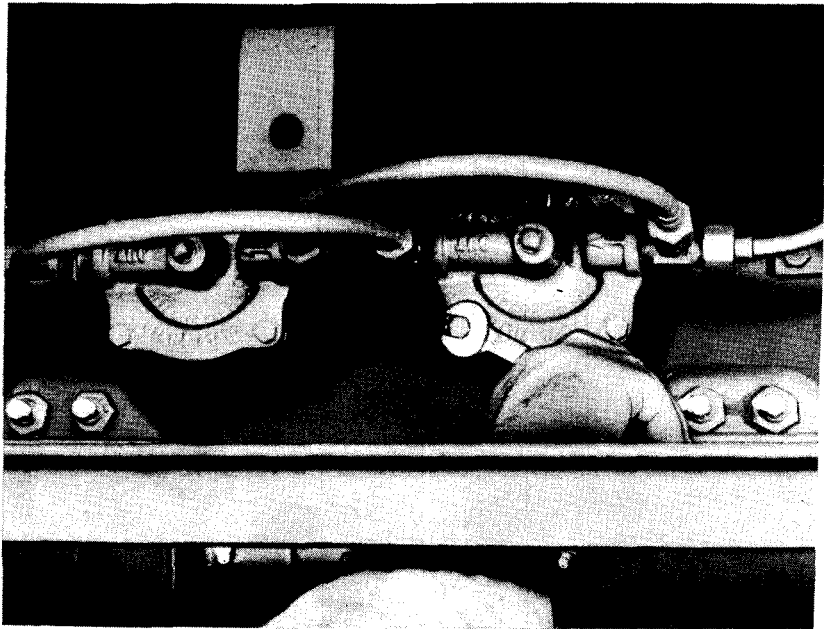

RA PD 17612

Figure 49—Removing First Stage Filter Cup

(2) REMOVAL.

WRENCH, open-end, $\frac{9}{16}$ -in.

WRENCH, open-end, $\frac{7}{8}$ -in.

WRENCH, open-end, $\frac{5}{8}$ -in.

WRENCH, socket, $\frac{9}{16}$ -in.

(a) Disconnect Fuel Lines.

WRENCH, open-end, $\frac{5}{8}$ -in.

WRENCH, open-end, $\frac{7}{8}$ -in.

Disconnect both inlet and outlet fuel lines.

(b) Remove Filter from Cowl.

WRENCH, open-end, $\frac{9}{16}$ -in.

WRENCH, socket, $\frac{9}{16}$ -in.

Remove the four bolts holding mounting bands to cowl and remove filter assembly.

(3) DISASSEMBLY.

WRENCH, open-end, $\frac{1}{2}$ -in.

(a) Remove Mounting Band Bolts.

WRENCH, open-end, $\frac{1}{2}$ -in.

Remove the bolts through mounting bands and slide bands off filter body.

FUEL AND AIR SYSTEM

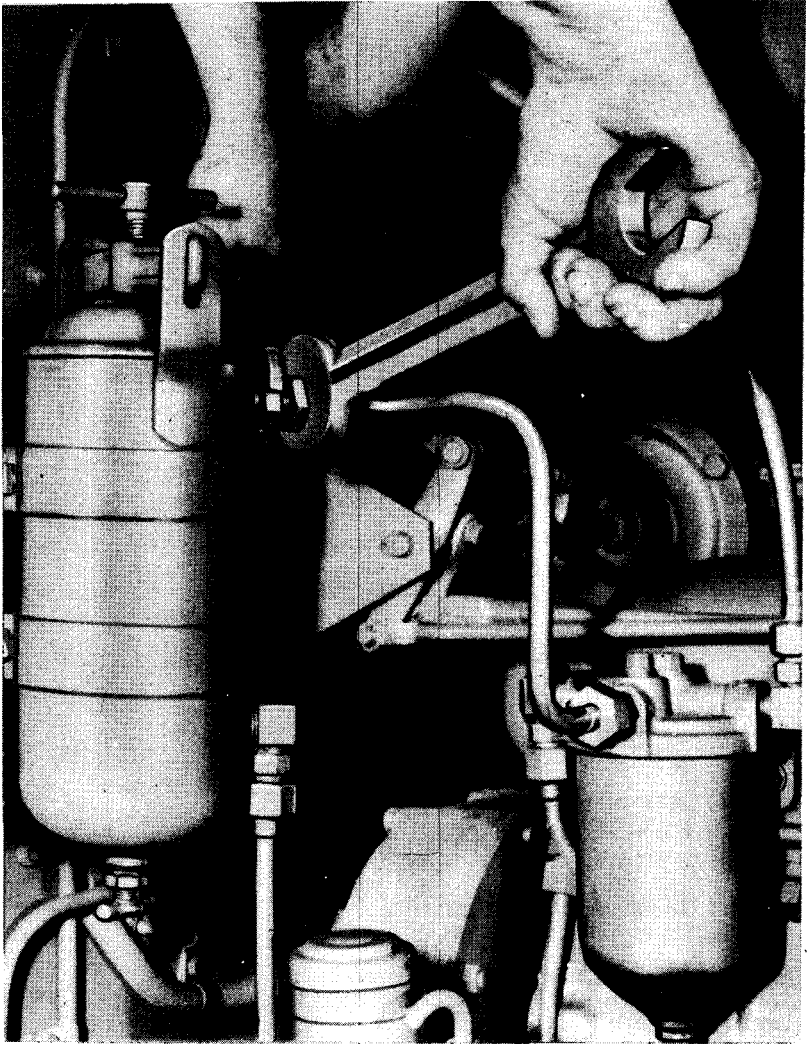

RA PD 17633

Figure 50—Disconnecting Fuel Line from Second Stage Filter

(b) Remove Filter Cover.

Loosen and remove cover hold-down screw, clamp, and cover.

(c) Lift Out Filter Element.

Lift element from filter.

(4) **MAINTENANCE.** Wash filter case out with clean fuel oil before installing new element. See that drain cock is not clogged. This drain cock

HEAVY TRACTOR M1

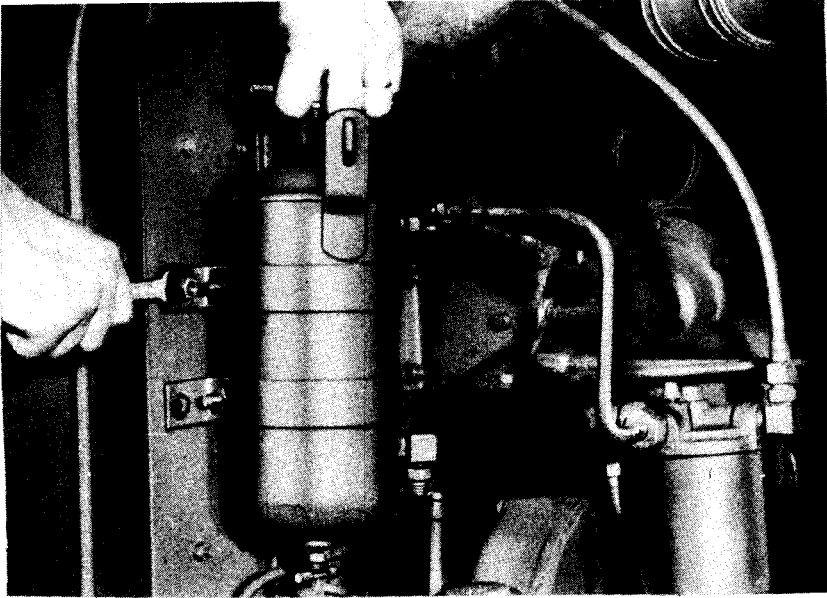

RA PD 17643

Figure 51—Removing Second Stage Filter Assembly

should be opened every day to drain sediment and water out of filter.
NOTE: To replace element only, the filter assembly should be left installed on the tractor and only the hold-down clamp and cover removed.

(5) REASSEMBLY.

WRENCH, open-end, 1/2-in.

(a) Install Element in Filter.

(b) Install Cover. Place new gasket and cover on filter and tighten cover with hold-down clamp and screw.

(c) Install Mounting Bands on Filter. Place bands on filter and install bolts through bands, leaving nut loose.

(6) INSTALLATION.

WRENCH, open-end, 1/2-in.

WRENCH, open-end, 7/8-in.

WRENCH, open-end, 3/16-in.

WRENCH, socket, 3/16-in.

(a) Install Filter Assembly on Cowl. Install bolts through mounting bands and cowl, and start nuts.

(b) Tighten Mounting Band Bolts.

WRENCH, open-end, 1/2-in.

(c) Tighten Bolts Holding Filter Assembly.

WRENCH, open-end, 3/16-in.

WRENCH, open-end, 7/8-in.

FUEL AND AIR SYSTEM

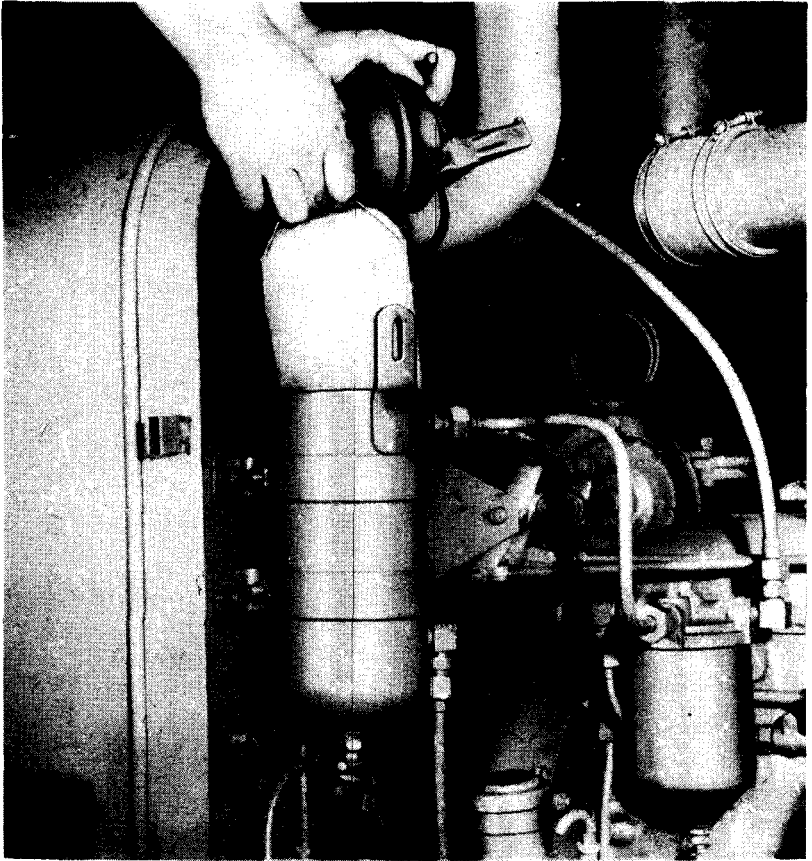

RA PD 17642

Figure 52—Removing Second Stage Filter Element

(d) *Connect Fuel Lines.* Connect lower fuel line, fill the filter with fuel (this will save cranking engine with starter to pump fuel to fill filter) and connect upper fuel line.

(e) *Check for Leaks.* Start engine and check for leaks.

e. Third Stage Fuel Filter.

(1) **GENERAL.** The fuel leaving the second stage filter passes into and through the third stage filter to the intake fuel manifold on the head. This filter also is of the replaceable element type.

(2) **REMOVAL.**

WRENCH, open-end, $\frac{7}{8}$ -in.

WRENCH, socket, $\frac{5}{8}$ -in.

WRENCH, socket, $\frac{9}{16}$ -in.

HEAVY TRACTOR M1

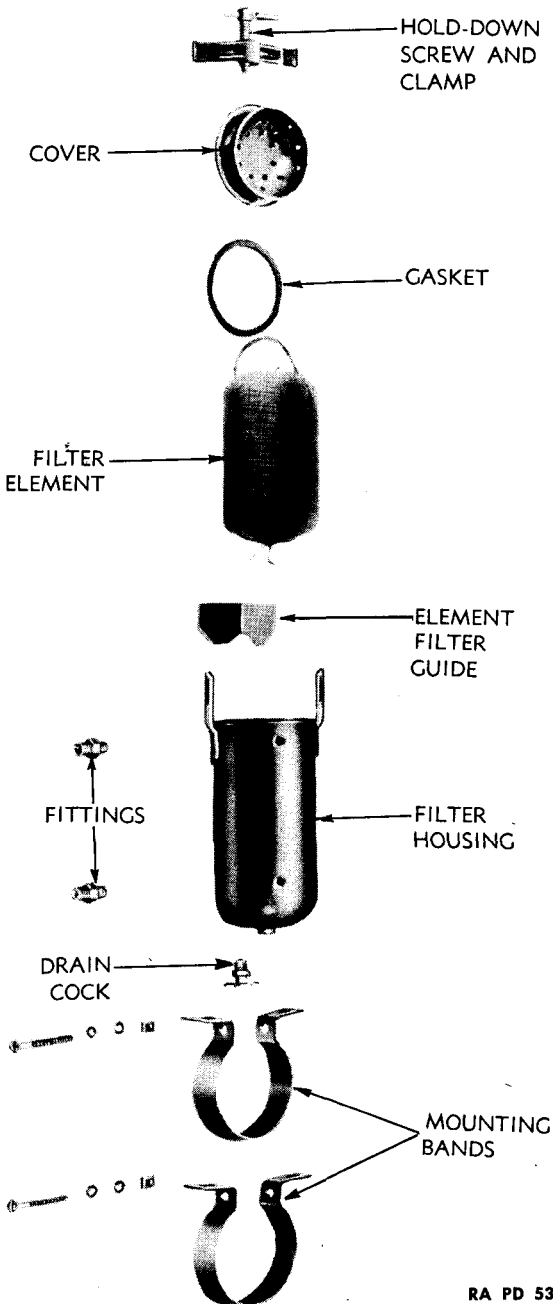

RA PD 53978

Figure 53—Second Stage Filter Assembly—Exploded View

FUEL AND AIR SYSTEM

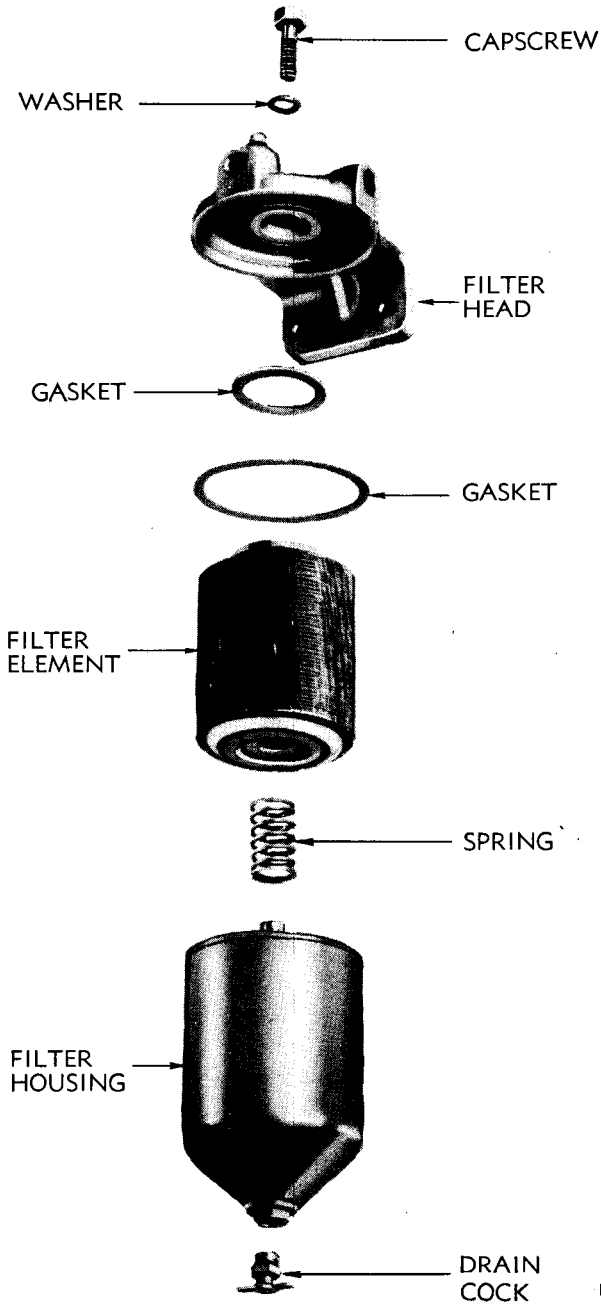

RA PD 53979

Figure 54—Third Stage Filter Assembly—Exploded View

HEAVY TRACTOR M1

(a) *Disconnect Fuel Lines.*

WRENCH, open-end, $\frac{7}{8}$ -in.

Disconnect the fuel lines from the fittings on filter head.

(b) *Drain Fuel from Filter.* Drain filter by opening drain cock at bottom of filter.

(c) *Remove Filter Housing.*

WRENCH, socket, $\frac{5}{8}$ -in.

Remove retaining cap screw holding filter housing to filter head and remove filter housing.

(d) *Remove Filter Head.*

WRENCH, socket, $\frac{9}{16}$ -in.

Remove two cap screws holding filter head to cylinder head and remove filter head.

(e) *Remove Element.* Lift element and spring from filter housing.

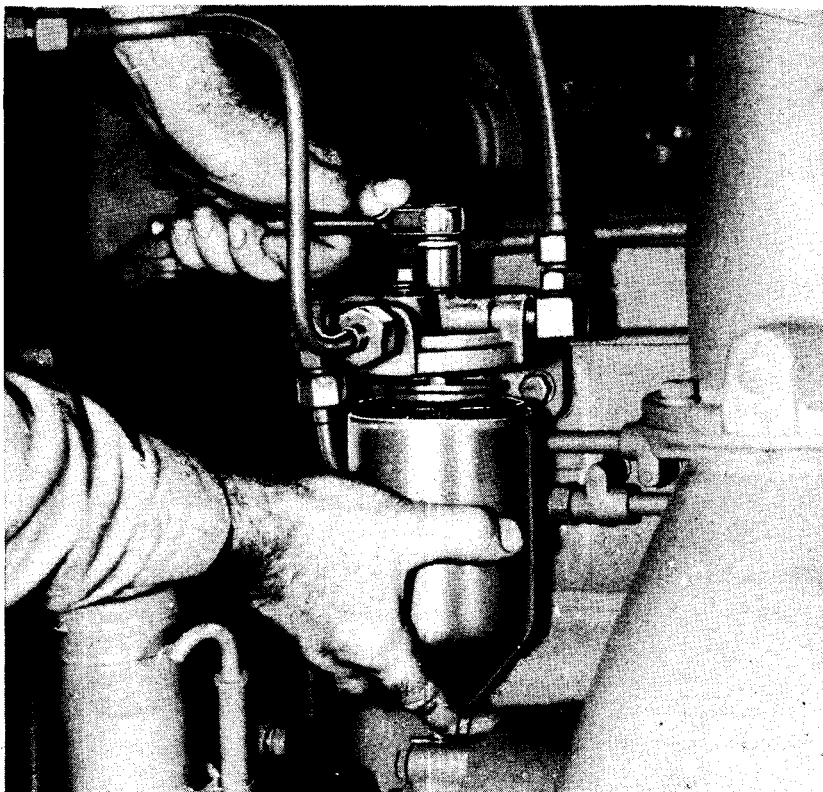

RA PD 17637

Figure 55—Removing Third Stage Filter Housing

FUEL AND AIR SYSTEM

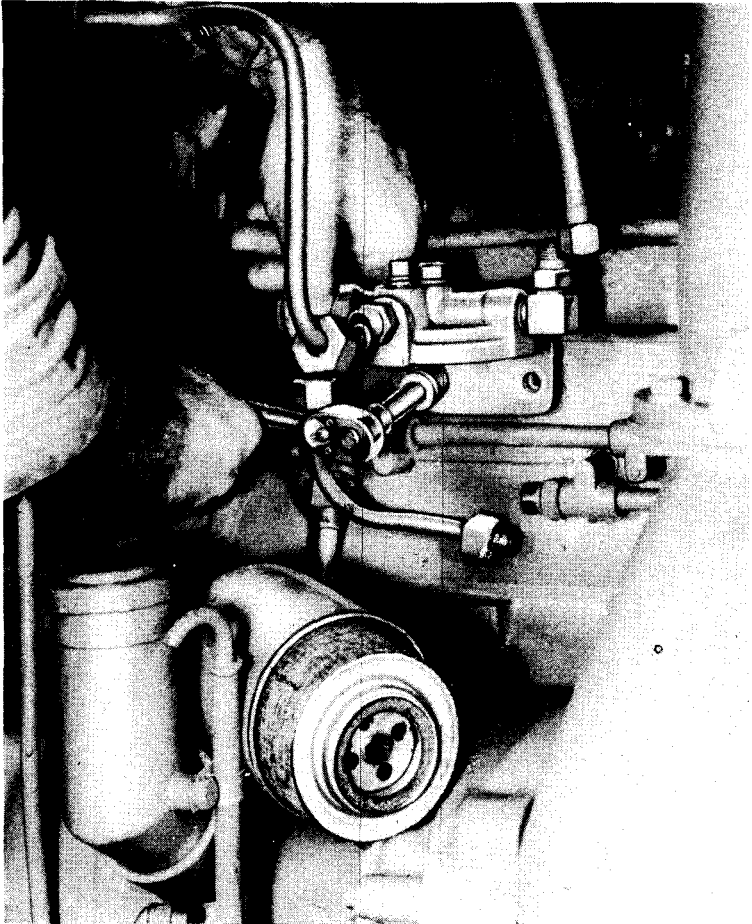

RA PD 17607

Figure 56—Removing Third Stage Filter Head

(3) **MAINTENANCE.** Clean filter housing with clean fuel oil after removing the element. The element may be replaced without removing the filter assembly from tractor. Remove the retaining screw and housing will drop down and out (fig. 55). Use new gasket supplied with each new element. Fill housing with fuel oil before installing housing on filter head. Open drain cock daily to drain sediment and water from filter.

(4) **INSTALLATION.**

WRENCH, open-end, $\frac{7}{8}$ -in.

WRENCH, socket, $\frac{5}{8}$ -in.

WRENCH, socket, $\frac{9}{16}$ -in.

HEAVY TRACTOR M1

*(a) Install Filter Head.*WRENCH, socket, $\frac{9}{16}$ -in.

Install filter head to cylinder head with two cap screws.

(b) Install Element in Housing. Install the spring and new element in the housing with the end marked "TOP" up, and fill the housing with fuel. NOTE: Two interchangeable types of filter cartridges are supplied for use in the third stage fuel filter. One is a cotton-wound type similar to the filter elements used in the filters located under the seat. A steel washer is supplied with each of these cartridges, and when this type filter element is used, the washer should be placed on the hollow stud inside the filter housing before the gasket and filter are installed.

*(c) Install Housing.*WRENCH, socket, $\frac{5}{8}$ -in.

Install new gaskets in filter head and on top of element; install cap screw and draw housing up to head (fig. 55).

*(d) Connect Fuel Lines.*WRENCH, open-end, $\frac{7}{8}$ -in.*(e) Check for Leaks.* Start engine and check for leaks.**69. FUEL PUMP.**

a. Description. The fuel pump is a positive displacement, vane-type pump. It is bolted to the rear end cover of the blower and is driven by the lower blower rotor shaft. A U-shaped steel stamping forms a part of the drive assembly and provides a safety release if the pump should lock for any cause.

b. Removal.WRENCH, box, $\frac{9}{16}$ -in.

WRENCH, special fuel pump

WRENCH, open-end, $\frac{7}{8}$ -in.**(1) CLOSE FUEL SHUT-OFF.****(2) DISCONNECT FUEL LINES FROM PUMP.**WRENCH, open end, $\frac{7}{8}$ in.

Disconnect inlet and outlet lines from pump.

(3) REMOVE FUEL PUMP FROM BLOWER.WRENCH, box, $\frac{9}{16}$ -in.

WRENCH, fuel pump

Remove the three cap screws holding fuel pump to blower. Use the special wrench to remove the cap screw nearest the cylinder block. Remove the fuel pump assembly and drive coupling fork as a unit.

c. Maintenance. No maintenance will be attempted by the using arm personnel.

d. Installation.WRENCH, box, $\frac{1}{2}$ -in.

WRENCH, special fuel pump

WRENCH, open-end, $\frac{7}{8}$ -in.

FUEL AND AIR SYSTEM

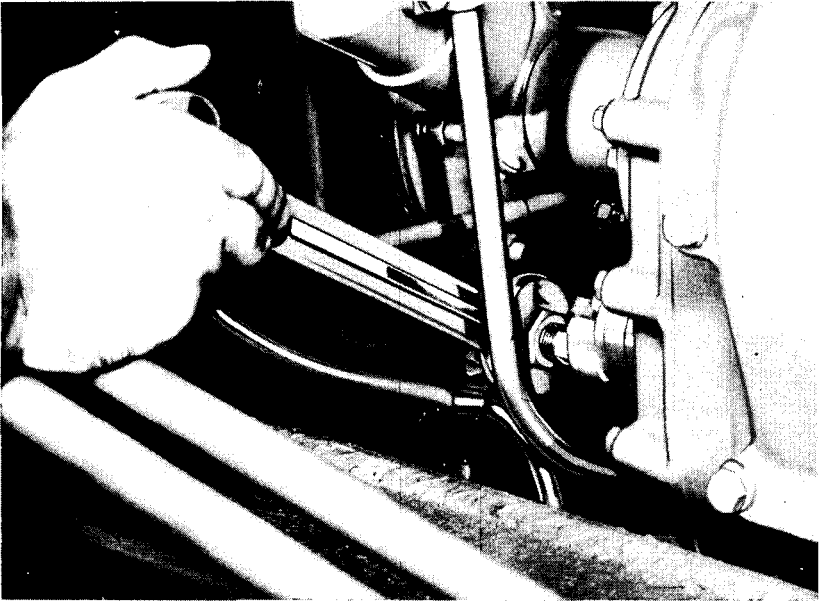

RA PD 17611

Figure 57—Disconnecting Fuel Lines from Fuel Pump

(1) **INSTALL COUPLING FORK ON PUMP.** Put drive coupling fork (arms out) on the square outer end of the pump shaft. Use a new paper gasket on the pump support flange.

(2) **INSTALL PUMP.**

WRENCH, box, 1/2-in.

WRENCH, special fuel pump

Install pump assembly on the blower end housing, engaging the drive fork in the slots of the driving plate on the lower blower rotor shaft. **NOTE:** The "IN" marking on the pump body should be on the cylinder block side, and the fuel line from the fuel supply tank connected to the fitting on the "IN" side of the pump body.

(3) **CONNECT FUEL LINES TO PUMP.**

WRENCH, open-end, 7/8-in.

(4) **OPEN FUEL SHUT-OFF VALVE.**

(5) **TEST FOR OPERATION.** Start engine and check for leaks and fuel pressure.

70. INJECTORS.

a. **General.** To secure combustion, a small quantity of accurately metered, finely atomized fuel must be mixed, near end of the compression stroke, with the charge of air which has been forced into the cylinder

HEAVY TRACTOR M1

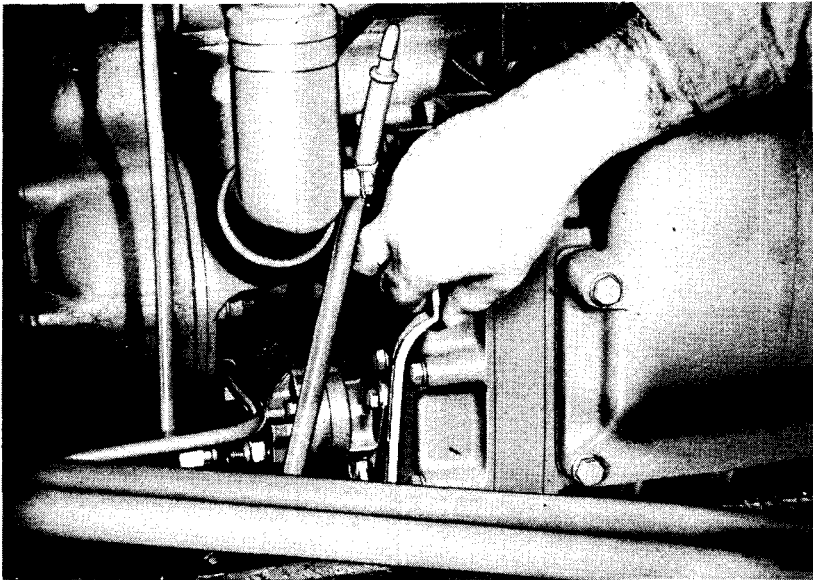

RA PD 17613

Figure 58—Removing Cap Screws from Pump with Special Wrench

by the blower. This is accomplished by an injector, which is a high pressure fuel injection device. There is one injector for each cylinder. The injectors in this 2-cycle engine are called unit injectors because they are a combination injection pump and injection nozzle or valve. The function of an injection pump is threefold: to meter out the exact amount of fuel to be supplied to each cylinder, to put that fuel under a pressure high enough to assure proper atomization or breaking up of the fuel for rapid ignition when it is released into the highly heated air of the cylinder, and to time its injection at exactly the right point in the operating cycle. The function of an injection valve is to insure that fuel is not admitted to the cylinder until it is at a high enough pressure to atomize properly for quick ignition, and that injection stops as soon as the pressure drops below the lowest permissible injection pressure. These functions are combined in the unit injector for each cylinder of this engine. For convenience, this combined pump and injector unit is here referred to as the injector.

b. The injectors are mounted in the cylinder head with their spray tips projecting slightly below the head into the combustion chambers. A clamp, bolted to the cylinder head, holds the injector in place in a water-

FUEL AND AIR SYSTEM

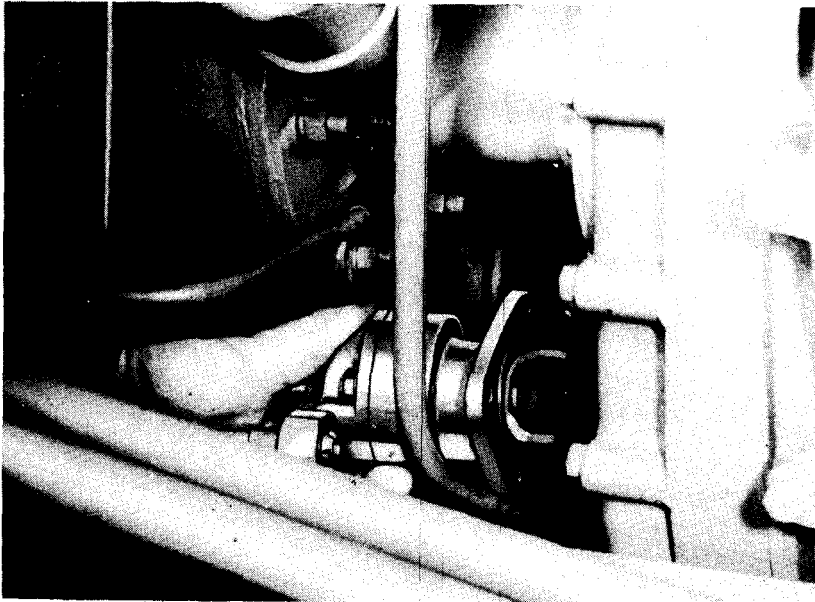

RA PD 17616

Figure 59—Removing Fuel Pump

cooled copper tube in the head. A dowel pin in the injector body registers with a hole in the cylinder head for accurately locating the injector assembly. A taper seat on the lower end of the injector, when seated in the copper tube in the cylinder head, forms a seal against the pressure of the compression in the cylinder.

c. Operation. Each injector is operated by a push rod and rocker arm in the same manner as the exhaust valves. As the piston nears the top of its compression stroke, the rocker arm forces the injector plunger down. The fuel is forced, by the plunger, into the combustion chamber through six holes in the injector spray tip. These holes, only 0.006 inch in diameter, distribute the fuel and break it into a very fine spray. A faulty injector will usually result in a loss of power, uneven operation of the engine, or a black exhaust smoke. Injectors can be "cut out" in much the same manner as shorting out spark plugs on a gasoline engine. With hood and rocker arm cover removed and engine running at about $\frac{1}{3}$ throttle, "cut out" one injector at a time by pushing down on the injector plunger follower with a stick of wood about $\frac{1}{2}$ inch square. **NOTE:** Damage may be done if a screwdriver is used. The one that seems to have no effect on the operation of the engine when "cut out"

HEAVY TRACTOR M1

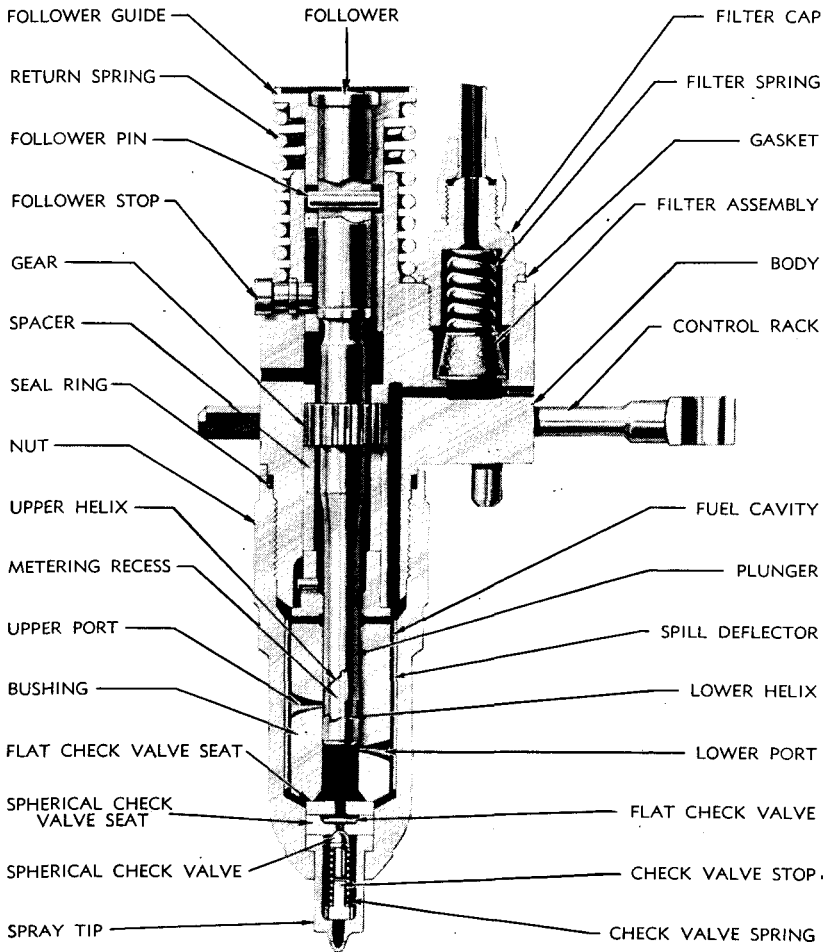

RAPD 17255

Figure 60—Cross Section of Injector

will be the faulty injector. It should be removed and a new or rebuilt injector installed.

d. Removal.

TOOL, injector remover

WRENCH, open-end, $\frac{7}{16}$ -in.

WRENCH, open-end, $\frac{1}{2}$ -in.

WRENCH, open-end, $1\frac{1}{16}$ -in.

WRENCH, socket, $\frac{9}{16}$ -in.

WRENCH, socket, $\frac{3}{4}$ -in.

(1) REMOVE PRECLEANERS

WRENCH, open-end, $\frac{7}{16}$ -in.

Loosen clamps holding precleaners to stacks and remove precleaners.

FUEL AND AIR SYSTEM

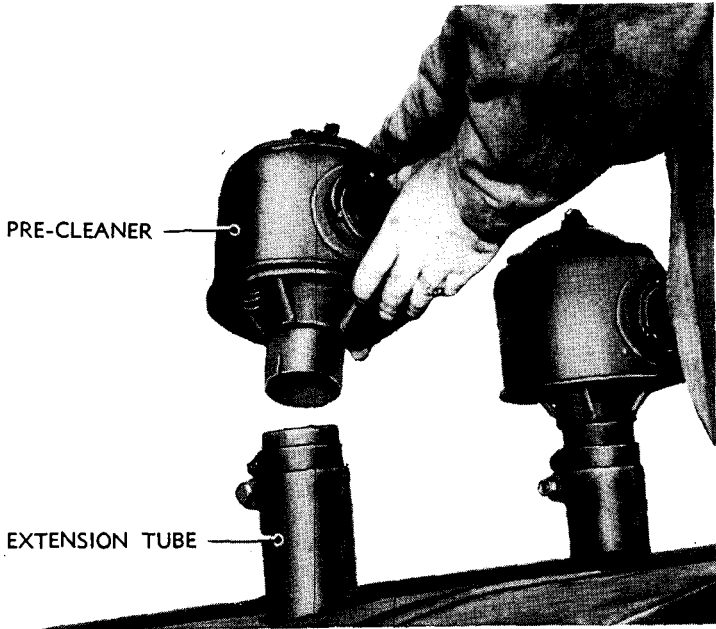

Figure 61—Removing Precleaners

(2) REMOVE HOOD.

WRENCH, open-end, $1\frac{1}{16}$ -in.

Loosen the nuts on the hood hold-down straps at each corner of the hood; pry bolts out of slot and remove the hood.

(3) REMOVE ROCKER ARM COVER. Clean the rocker arm cover thoroughly and remove the cover by loosening the two hand screws that hold the rocker arm cover to the cylinder head.

(4) REMOVE FUEL LINES.

WRENCH, open-end, $\frac{1}{2}$ -in.

Disconnect the fuel lines of the injector to be removed and place shipping caps on the fuel fittings to prevent dirt from entering the fuel system (fig. 33).

(5) REMOVE ROCKER SHAFT BRACKETS.

WRENCH, socket, $\frac{3}{4}$ -in.

With a $\frac{3}{4}$ -inch socket wrench, remove the two special cap screws that hold the rocker arm assembly to the head and slide the brackets off the rocker arm shaft (fig. 34).

HEAVY TRACTOR M1

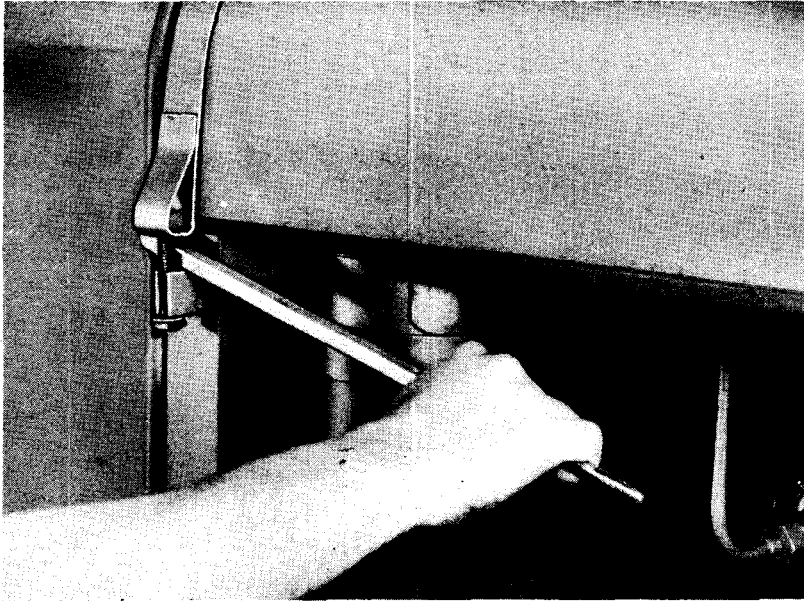

RA PD 17714

Figure 62—Removing Hood Clamp

(6) **REMOVE ROCKER ARM SHAFT.** Slide shaft from the rocker arms before laying the assembly back out of the way. This should be done to avoid bending the push rods.

(7) **REMOVE INJECTOR CLAMP.**

WRENCH, socket, $\frac{9}{16}$ -in.

Remove the nut holding clamp and lift off clamp washer and injector clamp.

(8) **REMOVE INJECTOR.**

TOOL, injector remover

Place square end of injector tool under shoulder of injector body and pry injector from its seat; at the same time disengage the control rack linkage.

e. **Testing Fuel Injectors** (fig. 60). An injector should always be tested before it is installed in the engine. This test, known as "popping the injector," is accomplished as follows:

(1) Place injector in test fixture.

(2) Using a clean oil can filled with clean fuel oil, introduce fuel into one of the injector openings until fuel flows from the other opening.

(3) To determine whether all six holes in the spray tip are open, move the injector rack into the "FULL FUEL" position; then forcibly

FUEL AND AIR SYSTEM

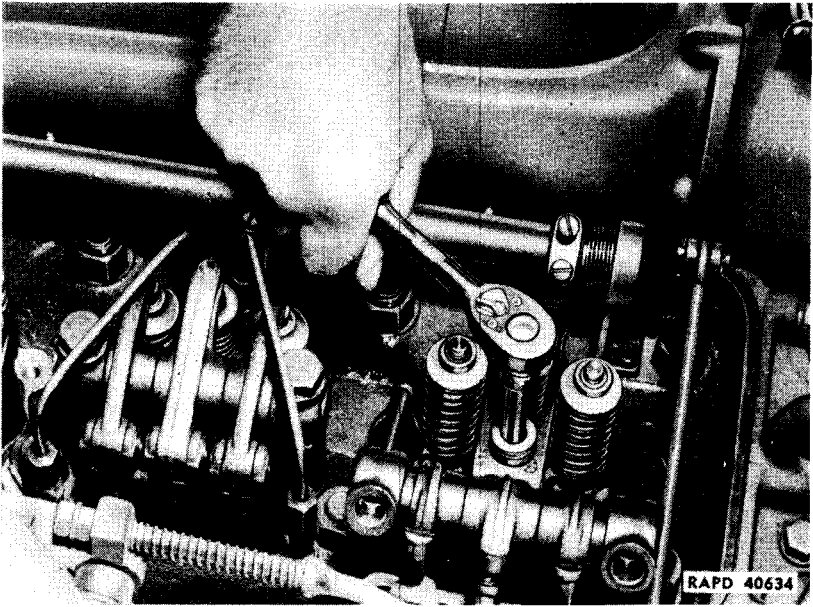

Figure 63—Removing Injector Clamp Nut

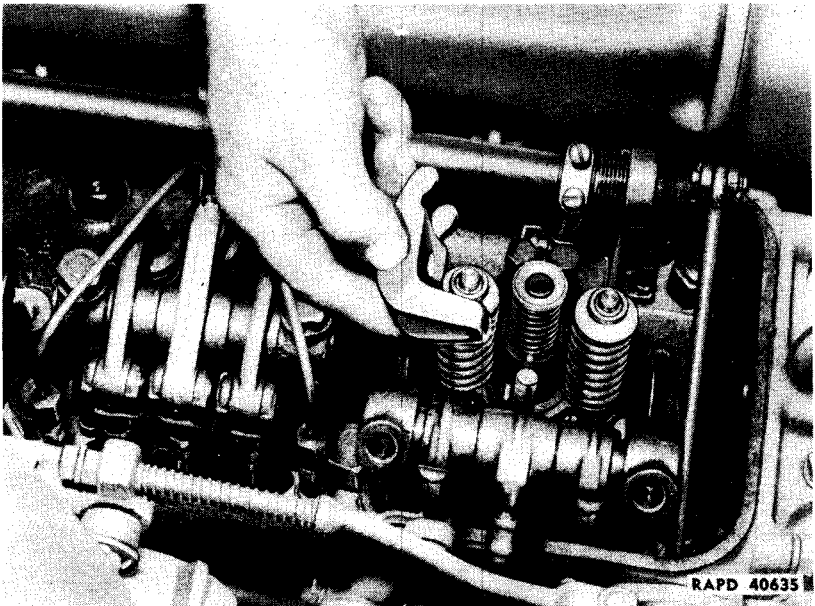

Figure 64—Lifting Out Injector Clamp

HEAVY TRACTOR M1

press the test handle down on the plunger follower with a quick motion. When the check valve opening pressure is correct, considerable downward pressure will be required on the fixture handle to pop the injector; if but little pressure is required, the check valve opening pressure is too low. **CAUTION:** Keep hands away from the spray tip when popping the injector, as the fuel from the spray tip will penetrate the skin and may cause blood poisoning. It is advisable to use a shield around the spray tip.

(4) Test for a leaky check valve by wiping or blowing all fuel from the spray tip, then pressing down on the fixture handle firmly, but not forcibly enough to open the check valve. Maintain a steady pressure while watching the spray tip. If oil appears, the check valve is not seating properly.

(5) If the injector fails to pass these tests, notify ordnance maintenance personnel. **NOTE:** Never remove the filter from the injector because of the risk of getting dirt into the oil passages.

f. Installation.

WRENCH, open-end, $\frac{1}{2}$ -in.

WRENCH, socket, $\frac{3}{4}$ -in.

WRENCH, socket, $\frac{9}{16}$ -in.

(1) PLACE THE INJECTOR IN THE INJECTOR TUBE. A dowel, provided on the injector body, registers with a hole in the cylinder head

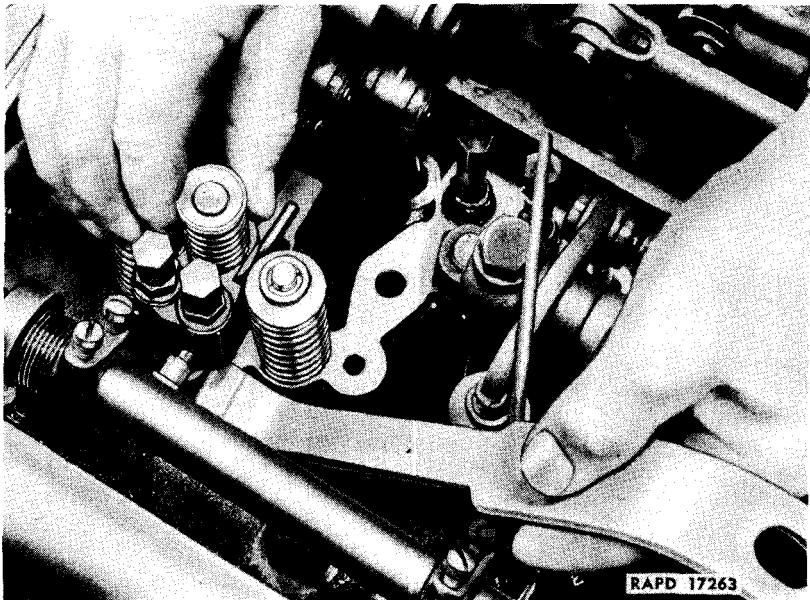

Figure 65—Injector Removal

FUEL AND AIR SYSTEM

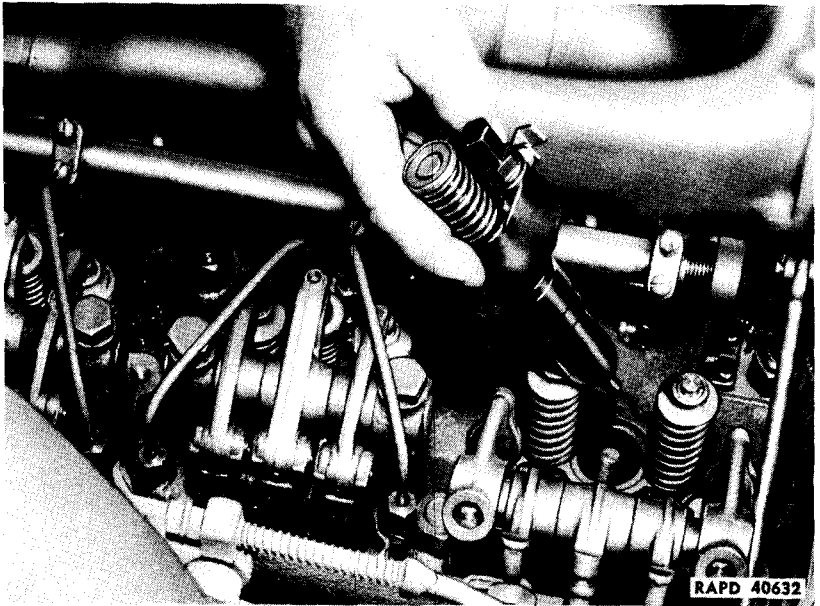

Figure 66—Injector Removed

so that the injector can be located in only one position in the head. Engage the control rack with the control lever at the same time.

(2) INSTALL THE INJECTOR CLAMP.

WRENCH, socket, $\frac{9}{16}$ -in.

Place clamp on the injector body, centering the side arms of the clamp as well as possible in the machined recesses in the injector body. Drop the special washer over the stud, with rounded side down. Put nut on stud and draw down clamp firmly, using wrench with 8-inch handle (fig. 63).

(3) INSTALL ROCKER ARM SHAFT AND BRACKETS. Slide shaft through rocker arms and place a bracket on each end of shaft, with the smooth side of brackets towards rocker arms.

(4) INSTALL CAP SCREWS.

WRENCH, socket, $\frac{3}{4}$ -in.

Draw brackets down firmly, at the same time holding rocker brackets loosely against rocker arms, allowing from 0.003-inch to 0.006-inch clearance.

(5) CONNECT FUEL LINES.

WRENCH, open-end, $\frac{1}{2}$ -in.

HEAVY TRACTOR M1

Remove the shipping caps from fuel fittings in head and on injectors, and connect fuel lines. After engine has been started, check for leaks before installing rocker arm cover. **NOTE:** The injector must be timed and equalized and the valve clearance adjusted (par. 60) before the rocker arm cover, hood, and precleaners are installed.

g. Injector Timing (fig. 67). The timing of an injector consists of properly locating the top of the injector plunger follower in relation to the injector body when it is at the top of its stroke. This distance is 1.484 inches and a special tool called a timing gage (in the injector service kit) is used to make the proper adjustment. After installation of an injector, or if the rocker arm assembly has been worked upon, the injector must always be timed and equalized before the engine is operated. The following procedure should be used to time the injectors.

(1) PULL FUEL SHUT-OFF TO "OFF" POSITION.

GAGE, timing

WRENCH, open-end, $\frac{5}{16}$ -in.

SCREWDRIVER, small

WRENCH, open-end, $\frac{1}{2}$ -in.

Do not allow the engine to start. Crank engine with the starting motor until the exhaust valves of the cylinder on which the injector is to be timed are fully opened. When the rocker arms have depressed the exhaust valves, the injector may be timed.

(2) SET TIMING GAGE IN POSITION.

GAGE, timing

SCREWDRIVER, small

Place the timing gage in the timing hole in the injector body. The knurled head or sleeve should be turned to the left as far as possible. Hold the gage vertical with a firm downward pressure with a small screwdriver engaged in the slot in the top of the timing gage shaft. Make certain that the shoulder at the lower end of the timing gage shaft rests squarely on the injector body and is not resting on the copper gasket under the fuel line fitting in the injector.

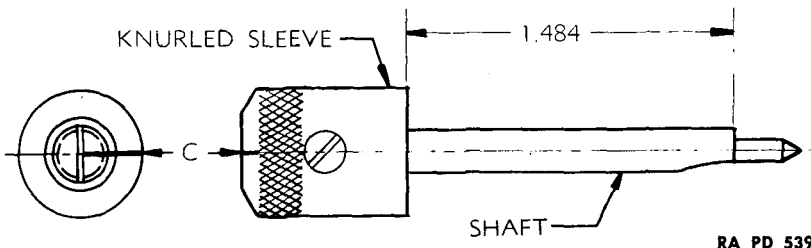
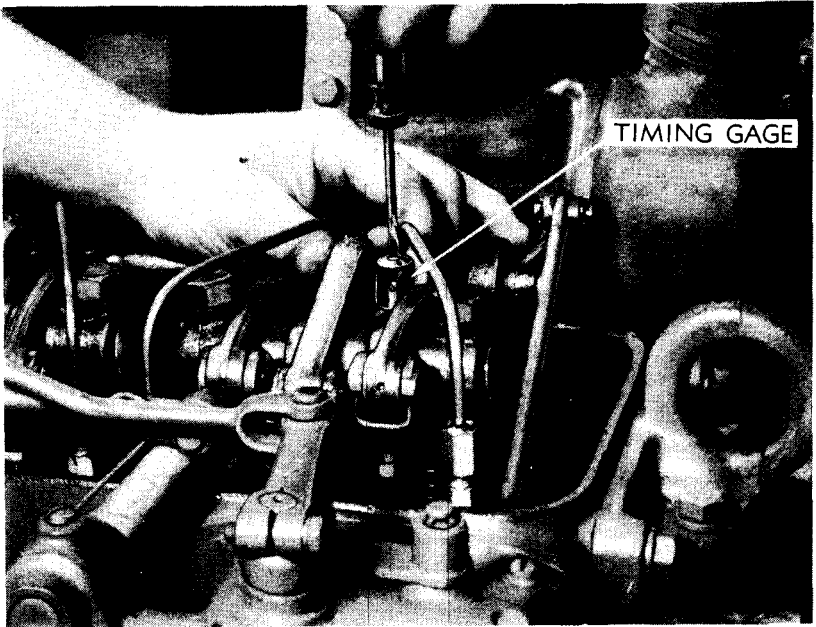

Figure 67—Injector Timing Gage

FUEL AND AIR SYSTEM



RA PD 56386

Figure 68—Injector Timing

(3) CHECK PRESENT SETTING.
GAGE, timing

Rotate the knurled sleeve to the right until the lower shoulder of the sleeve rests squarely on the edge of the follower guide. If the top of the shaft and the sleeve are not flush and the marks "C" on the sleeve and shaft are not in line, the push rod must be lengthened or shortened to obtain the proper adjustment.

(4) ADJUST PUSH ROD.

WRENCH, open-end, 1/4-in.

WRENCH, open-end, 1/2-in.

Loosen the lock nut on the push rod. Adjust the rocker arm by turning the push rod to the right to shorten it, which will allow the injector plunger follower to come up. Turning the push rod to the left will lengthen the push rod and will push the plunger follower guide down. When the timing marks line up, with a small allowance for a slight change which occurs when the lock nut is tightened, the sleeve should also be flush with the top of the timing shaft. Tighten the lock nut on the push rod. The timing marks should now be exactly in line. If they are not in line, change the adjustment slightly until the marks line up when the lock nut is tight.

HEAVY TRACTOR M1

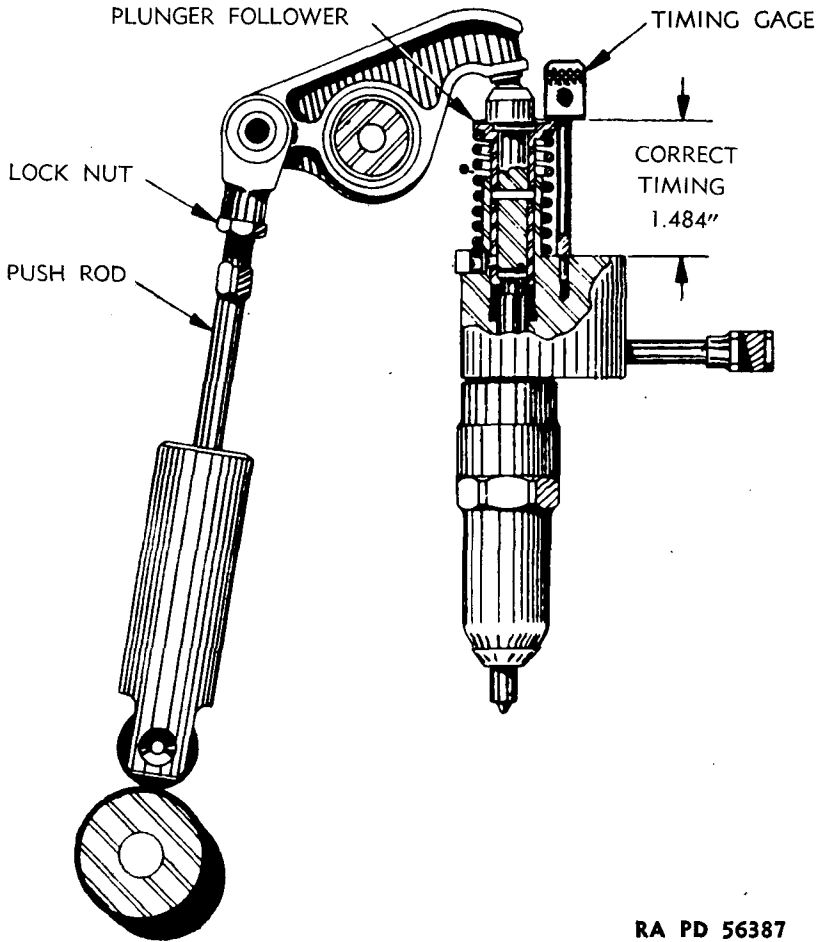

RA PD 56387

Figure 69—Correct Timing of Injector

h. Injector Equalizing. This operation consists of properly adjusting all injector control racks to obtain an equal fuel injection from each injector. Accurate timing of the injectors is essential before they are equalized. The injector must be timed and equalized every time any part of the engine is worked on which might affect the position of the injector or rocker arm assembly. Equalizing is accomplished by the following procedure.

(1) PUSH FUEL SHUT-OFF FORWARD (OPEN).

PLIERS

SCREWDRIVER

Push fuel shut-off all the way forward and pull throttle back (open) as far as possible.

FUEL AND AIR SYSTEM

(2) LOOSEN ADJUSTING SCREWS.

SCREWDRIVER

Loosen all adjusting screws on the rack control levers and be sure the levers are free on the control tube and that the control tube rotates freely in the bearings.

(3) DISCONNECT GOVERNOR CONTROL LINK.

PLIERS

Remove link pin from governor control link and control tube lever. All injector control racks should move freely and the injector control tube assembly should return to the "NO INJECTION" position (injector rack out) when the governor control link is disconnected.

(4) ADJUST FOR CONTROL RACK AND GEAR CLEARANCE.

SCREWDRIVER

Hold the throttle lever on the top of the governor in full load position and turn the lower adjusting screw for No. 1 injector in until the hole for the pin in the control tube lever is $\frac{1}{64}$ of an inch out of line with the hole in the governor control link (fig. 70). Turn the upper adjusting screw down and tighten both screws lightly so the $\frac{1}{64}$ -inch spacing is maintained.

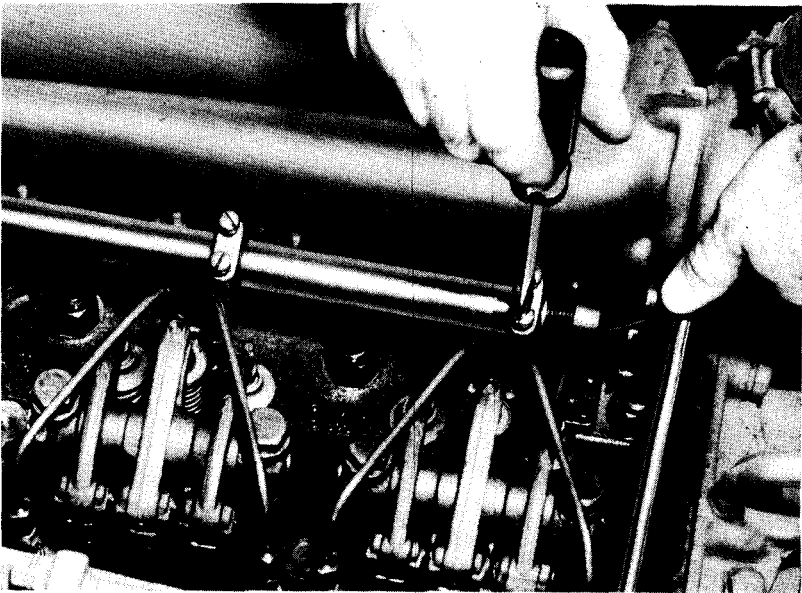

RA PD 17664

Figure 70—No. 1 Control Rack Adjustment

HEAVY TRACTOR M1

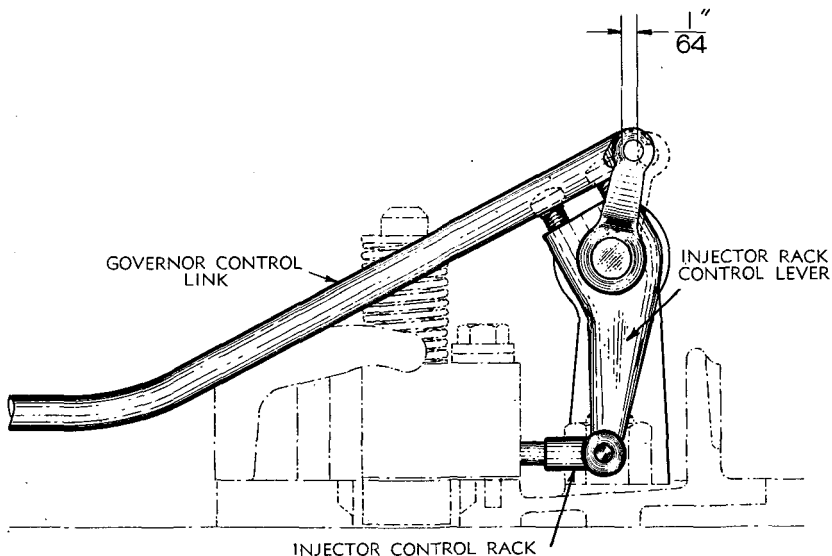

Figure 71—Clearance for Control Rack and Gear

(5) **ADJUST REMAINING RACK CONTROL LEVERS.** Hold No. 1 rack control lever against No. 1 injector control rack in its "IN" position and adjust the remaining rack control levers until the lugs on all rack control levers just contact the inner faces of the slots in the injector control racks. **CAUTION:** The adjusting screws will be damaged if drawn too tightly. If they are just screwed down firmly, they will not loosen.

(6) **CONNECT GOVERNOR CONTROL LINK.** Install link pin in governor control link and control tube lever, and secure with cotter pin. Install rocker arm cover, start engine, and test for proper operation.

71. FUEL LINES AND CONNECTIONS.

a. The fuel lines and connections should be inspected regularly and any damaged or defective parts removed for repair, or replaced with new ones. The fuel lines are steel tubing, and it is important to avoid bending them. All clips that hold the fuel lines to the tractor transmission case and to the engine should be tight. Practically all the fuel line connections have connector nuts requiring a $\frac{7}{8}$ -inch open-end wrench. Any time a fuel connection is broken, the engine should be started after the line is connected again and inspection made for leakage of fuel or loss of fuel pressure due to air being drawn into the fuel system through a defective or loose connection.

FUEL AND AIR SYSTEM

b. It is important that the clips holding fuel lines to parts of the tractor be installed again in the proper places when lines are replaced. These clips prevent breakage of lines from vibration. Always use a wrench, not pliers, when connecting or disconnecting fuel lines.

72. PRECLEANERS.

a. **Description.** The United precleaners, model C-11215, are of the cyclone type. Approximately 85 percent of the dirt entering with the air is removed by them before the air reaches the oil bath air cleaner. Glass inspection ports make it easy for the operator to observe the quantity of dirt and dust in the dirt compartment and enables him to readily determine when it should be emptied from the precleaners. If precleaners become damaged, they should be immediately replaced.

b. Removal.

WRENCH, open-end, $\frac{7}{16}$ -in. (2)

(1) LOOSEN CLAMP.

WRENCH, open-end, $\frac{7}{16}$ -in. (2)

Loosen clamp bolt at base of precleaner and lift off precleaner assembly (fig. 61).

c. **Maintenance.** The precleaners should be emptied daily, or oftener if necessary. In any case, they should be emptied before dirt is level with top of glass.

(1) Remove wing nut assembly from the top of precleaners and remove bowl.

(2) Shake dust from dirt compartment.

(3) Wipe glass and reassemble. Replace rubber gasket if present one is not in good condition.

(4) Tighten wing nut with fingers. **CAUTION:** Do not use a wrench.

d. Installation.

WRENCH, open-end, $\frac{7}{16}$ -in. (2)

(1) PLACE PRECLEANER ASSEMBLY ON PIPE.

WRENCH, open-end, $\frac{7}{16}$ -in. (2)

Place precleaner assembly in position over pipe, pushing it down as far as possible, and tighten clamp bolt.

73. AIR CLEANER.

a. **Description.** A United oil bath air cleaner, model CT 85 9665, is used on this tractor and is mounted under the tractor cowl. It consists of two air cleaner assemblies connected to one bracket. Oil cups with baffle plates are suspended at the lower end of the air cleaner assemblies and are filled to a specified level with engine oil. As the air is drawn through the cleaners, a portion of this oil is whipped up into screen

HEAVY TRACTOR M1

mats in the main body of the cleaners. The dust in the air collects on these oily screen mats as the air is drawn through them and, as a result, only clean air reaches the engine. The oil dripping back into the cups from the screen mats carries the dirt with it and deposits it in the cups. The cups must be removed periodically and cleaned to remove this dirt. A broken hose, loose clamps, or a leak of any kind between the air cleaners and the blower will defeat the purpose of the cleaner; therefore, care should be taken to see that all connections are tight.

b. Maintenance. The cleaners must be checked every 8 hours of operation. Remove the oil cups and check the amount and condition of the filtering oil. In extremely dusty conditions, the oil should be changed every 8 to 10 hours and the air inlet pipe in the air cleaner swabbed out to remove any dust accumulation on the sides of the passage. Improper care of the air cleaners will result in abnormal wear on blower, rings, pistons, and cylinder liners. The air cleaner should be serviced as follows:

- (1) Swing bail assembly from under cup and remove cup.
- (2) Remove baffle ring and baffle.
- (3) Empty oil and dirt and thoroughly clean cup, baffle, and baffle ring.

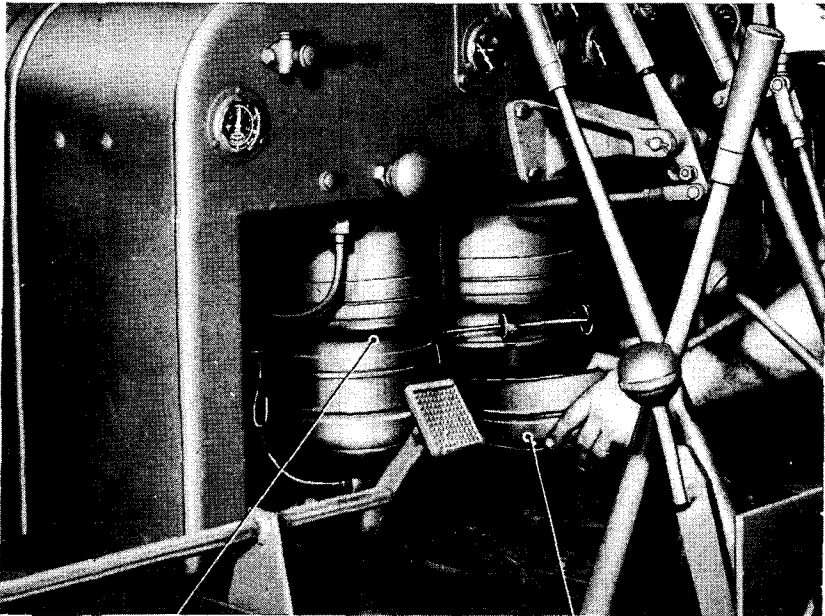

AIR CLEANER

AIR CLEANER CUP

RA PD 17621

Figure 72—Removing Air Cleaner Cup

FUEL AND AIR SYSTEM

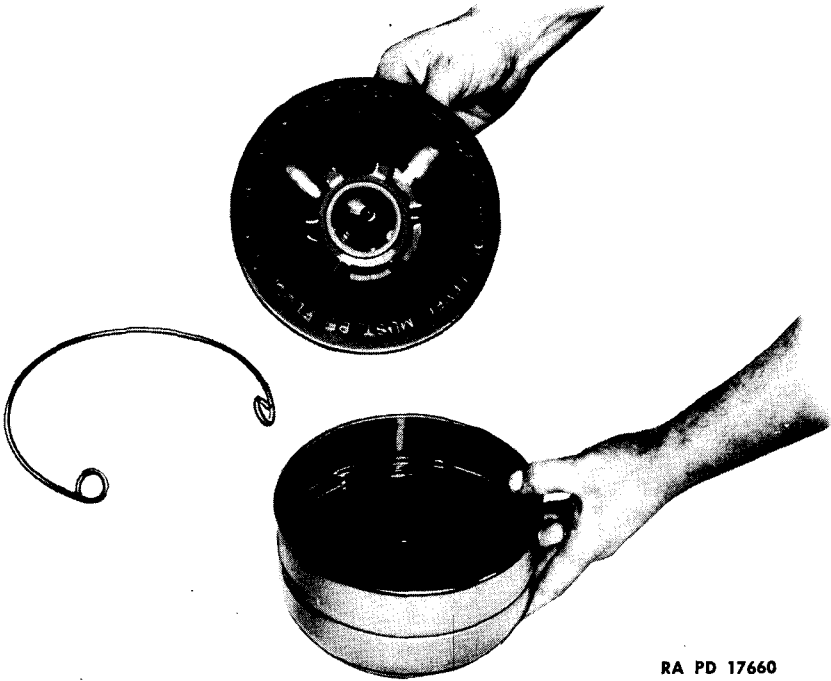

RA PD 17660

Figure 73—Removing Baffle and Baffle Ring

(4) Replace baffle and baffle ring, and fill cup to the oil level line at top of cone with OIL, engine, SAE 30. (See section IV for proper seasonal grade). **CAUTION:** Do not use a Diesel engine oil in the air cleaner as oils of this type are likely to foam and reduce the efficiency of the air cleaner.

(5) Replace cup on cleaner assembly and snap bail assembly into place under the cup.

HEAVY TRACTOR M1

Section XIII

COOLING SYSTEM

| | Paragraph |
|-----------------------|-----------|
| Description | 74 |
| Water pump | 75 |
| Water manifold | 76 |
| Radiator | 77 |
| Thermostat | 78 |
| Hoses and pipes | 79 |
| Fan assembly | 80 |

74. DESCRIPTION.

a. Cooling of the engine is accomplished by means of water circulated through the cylinder block and cylinder head by a centrifugal pump mounted on the front end of the blower and driven by the lower blower rotor shaft. This pump delivers the heated water to the top of the radiator core. A cooling fan is provided which draws air through the radiator core, thus dissipating the heat and lowering the water temperature while it passes from the top to the bottom of the radiator.

b. Keep cooling system filled with clean water that is free from lime or other alkajies. Use a standard antifreeze solution in the cooling system in winter weather. The solution should be tested daily and kept at the proper strength for prevailing temperatures. The antifreeze used should have a higher boiling point than the normal operating temperature of the engine (160 to 180 F).

c. The cooling system has two drain points (fig. 24) and both of these should be opened when the cooling system is drained or the unit is stored. One drain cock is in the bottom of the water pump housing and the other is in the bottom of the elbow connecting the radiator to the lubricating oil cooler assembly. **CAUTION:** When refilling cooling system, remove the ¼-inch pipe plug in the thermostat housing. This will permit air to escape from the head and block. As soon as water runs out of the hole freely, the plug should be replaced and the system filled to its specified capacity, 9¾ gallons.

75. WATER PUMP.

a. **Description.** The water pump is mounted on the forward end of the blower housing (fig. 76). It is driven by the lower blower rotor shaft through a jaw type coupling. This coupling fits on the shaft with a light press fit. If the pump becomes frozen or otherwise bound, the coupling

COOLING SYSTEM

will turn on the shaft and will thus prevent damage to the pump itself. If this happens the pump must be removed and repaired or replaced, and the coupling must be replaced.

b. Trouble Shooting.

(1) OVERHEATING.

| Probable Cause | Probable Remedy |
|---|-------------------|
| Pump drive shaft coupling turning on shaft. | Replace coupling. |
| Impeller turning on shaft. | Replace pump. |

(2) NOISY PUMP.

| | |
|---------------------|---------------|
| Bearing defective. | Replace pump. |
| Impeller defective. | Replace pump. |

(3) LOSS OF WATER.

| | |
|-------------------------|---------------|
| Water pump seal faulty. | Replace pump. |
|-------------------------|---------------|

c. Removal.

| | |
|----------------------------|----------------------------------|
| SCREWDRIVER | WRENCH, open-end, 3/4-in. |
| TOOL, water pump drain | WRENCH, socket, 3/4-in. |
| WRENCH, open-end, 1/2-in. | WRENCH, water pump and fuel pump |
| WRENCH, open-end, 9/16-in. | |
| WRENCH, open-end, 5/8-in. | |

(1) DRAIN COOLING SYSTEM.

TOOL, water pump drain

Open both water pump and radiator drain cocks. If antifreeze solution is in cooling system, drain into clean containers to save for refilling radiator.

(2) REMOVE RIGHT FRONT FENDER.

WRENCH, open-end, 3/4-in. WRENCH, socket, 3/4-in.

Remove three bolts and one cap screw holding fender and remove fender.

(3) REMOVE GOVERNOR BREATHER TUBE.

SCREWDRIVER

Remove two screws holding top of tube to governor housing and lift tube out of clip on oil cooler housing.

(4) DISCONNECT AIR COMPRESSOR WATER INLET LINE.

WRENCH, open-end, 5/8-in. WRENCH, socket, 9/16-in.

Remove cap screw from clip holding tube against balance weight cover. Disconnect water line from pump.

HEAVY TRACTOR M1

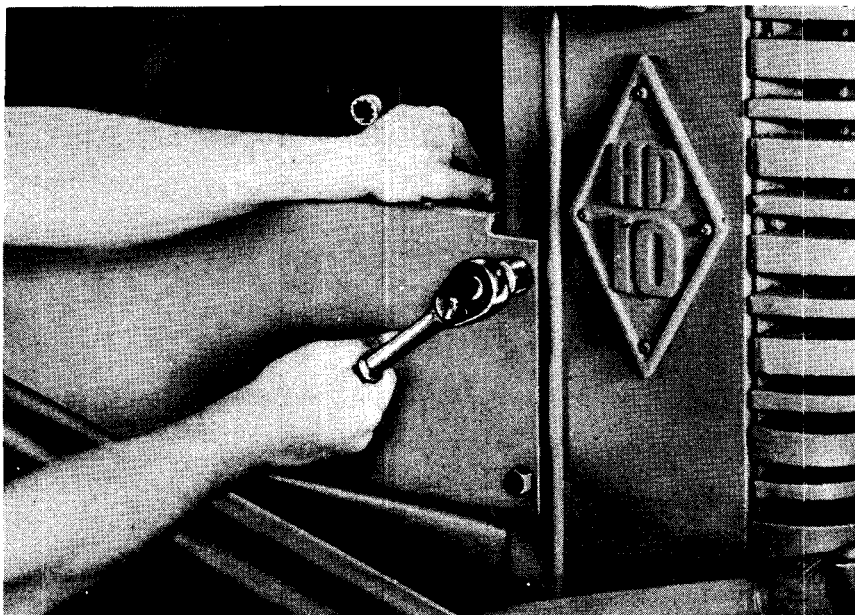

RA PD 17807

Figure 74—Removing Front Fender

(5) DISCONNECT HOSE.

SCREWDRIVER

Loosen hose clamp on hose connection between water pump and oil cooler.

(6) DISCONNECT PUMP OUTLET PACKING FLANGE.

WRENCH, open-end, 1/2-in.

Remove the two cap screws holding pump outlet packing flange to cylinder block.

(7) REMOVE PUMP ASSEMBLY.

WRENCH, water pump and fuel pump

Remove the three cap screws holding water pump to front end of blower and remove pump assembly and coupling.

d. Installation.

SCREWDRIVER

TOOL, water pump drain

WRENCH, open-end, 1/2-in.

WRENCH, open-end, 9/16-in.

WRENCH, open-end, 5/8-in.

WRENCH, open-end, 3/4-in.

WRENCH, socket, 3/4-in.

WRENCH, water pump and fuel pump

COOLING SYSTEM

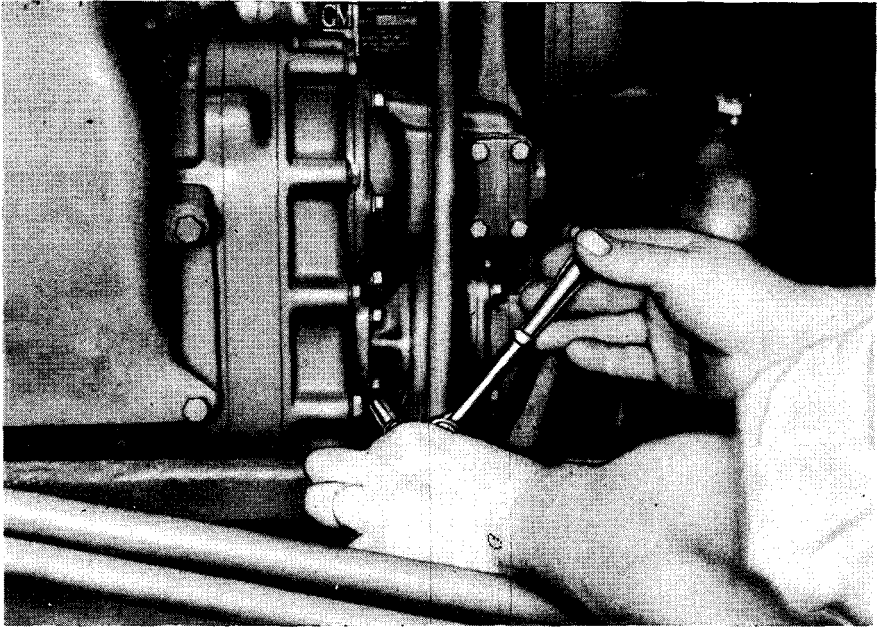

RA PD 17618

Figure 75—Removing Cap Screws from Packing Flange

(1) **INSTALL NEW COUPLING ON PUMP SHAFT.** Place coupling on pump shaft with jaws pointing towards blower. See that packing flange and packing ring are in position on the discharge pipe and that the hose connection from the pump to the oil cooler is in place. Use new gasket, if necessary.

(2) **INSTALL PUMP ASSEMBLY.**

WRENCH, water pump and
fuel pump

Install the pump assembly on the front end cover of the blower with three cap screws taking care that the driving jaws of the coupling engage the driving assembly on the blower rotor shaft.

(3) **TIGHTEN ALL HOSE CONNECTIONS.**

(4) **CONNECT AIR COMPRESSOR WATER INLET LINE.**

SCREWDRIVER

WRENCH, socket, $\frac{1}{16}$ -in.

WRENCH, open-end, $\frac{5}{8}$ -in.

Connect water inlet line to pump and install cap screw through pipe clip and into balance weight cover.

HEAVY TRACTOR M1

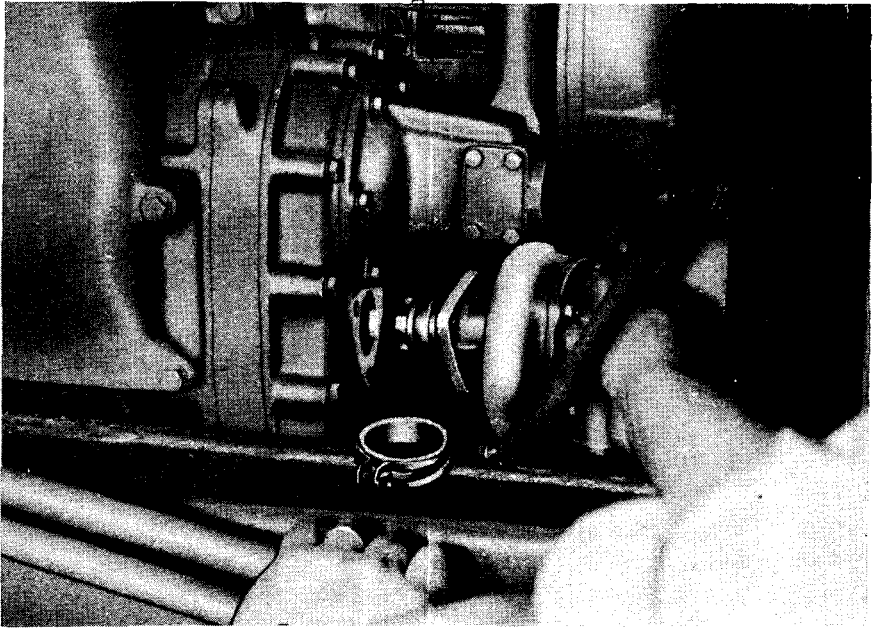

RA PD 17617

Figure 76--Removing Water Pump

(5) CONNECT PUMP OUTLET PACKING FLANGE.
WRENCH, open-end, 1/2-in.

(6) INSTALL BREATHER TUBE.
SCREWDRIVER

Insert lower end of tube through clip on oil cooler and install screws holding tube to governor housing.

(7) FILL COOLING SYSTEM.
TOOL, water pump drain

Close drain cocks; fill cooling system; start engine and check for leaks.
NOTE: As the water pump ball bearing is the "shielded" type and filled with lubricant when assembled, no further lubrication is necessary.

76. WATER MANIFOLD.

a. **Description.** The water manifold is bolted to the left side of the cylinder head and discharges the cooling water back into the radiator. The thermostat is located in a special housing bolted to the front end of the manifold and its purpose is to restrict the flow of cooling water to automatically maintain the correct temperature for proper engine operation.

COOLING SYSTEM

b. Water Manifold Removal.

SCREWDRIVER

WRENCH, open-end, $\frac{5}{8}$ -in.

WRENCH, open-end, $\frac{1}{2}$ -in.

WRENCH, open-end, $1\frac{1}{16}$ -in.

WRENCH, open-end, $\frac{9}{16}$ -in.

(1) DRAIN COOLING SYSTEM.

(2) DISCONNECT HOSE FROM THERMOSTAT HOUSING.

SCREWDRIVER

(3) REMOVE THERMOSTAT HOUSING.

WRENCH, socket, $\frac{1}{2}$ -in.

Remove three cap screws from thermostat housing and disconnect water bypass tube from thermostat (fig. 78).

(4) REMOVE WATER LINE.

WRENCH, open-end, $\frac{5}{8}$ -in.

Remove water line leading to the air compressor.

(5) REMOVE THERMO GAGE TUBE.

WRENCH, open-end, $1\frac{1}{16}$ -in.

Remove tube of thermo gage from rear of manifold.

(6) REMOVE MANIFOLD.

WRENCH, open-end, $\frac{9}{16}$ -in.

Remove the eight nuts and lock washers from stud bolts holding manifold to head and lift off manifold.

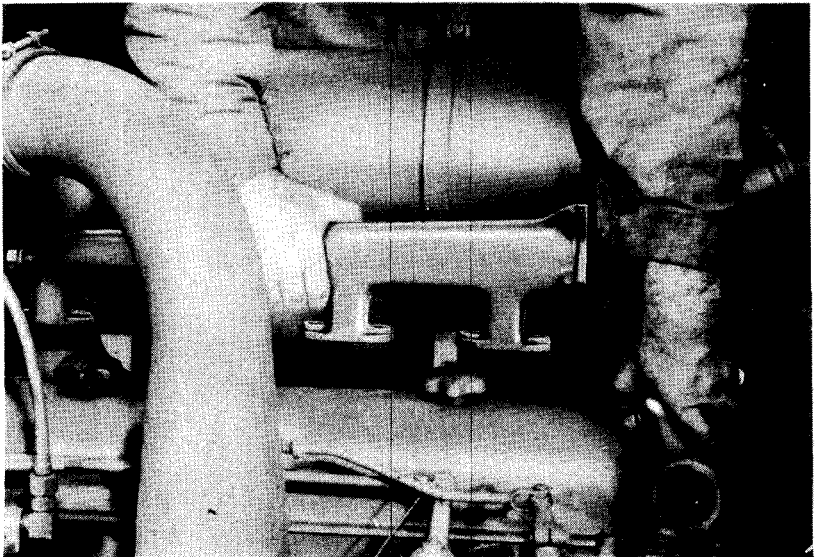

RA PD 17631

Figure 77—Removing Water Manifold

HEAVY TRACTOR M1

c. Installation.

| | |
|--------------------------------------|--|
| GREASE, chassis | WRENCH, open-end, $\frac{9}{16}$ -in. |
| SCREWDRIVER | WRENCH, open-end, $\frac{5}{8}$ -in. |
| SHELLAC | WRENCH, open-end, $1\frac{1}{16}$ -in. |
| WRENCH, open-end, $\frac{1}{2}$ -in. | |

(1) **INSTALL GASKETS ON MANIFOLD.** Scrape all old gaskets off head and manifold, and shellac new gaskets to manifold. Coat other side of gaskets with chassis grease.

(2) **INSTALL MANIFOLD ON HEAD.**

WRENCH, open-end, $\frac{9}{16}$ -in.

Place the manifold on the head and tighten all the nuts evenly.

(3) **INSTALL THERMO GAGE TUBE.**

WRENCH, open-end, $1\frac{1}{16}$ -in.

Install the thermo gage and tube in the rear end of the manifold.

(4) **INSTALL THERMOSTAT AND HOUSING.**

WRENCH, open-end, $\frac{1}{2}$ -in.

Install the thermostat and housing and connect the water bypass tube to the thermostat housing (fig. 79).

(5) **INSTALL WATER LINE.**

WRENCH, open-end, $\frac{5}{8}$ -in.

Install water line leading to air compressor.

(6) **FILL COOLING SYSTEM.** Fill the cooling system, start the engine and inspect for leaks.

77. RADIATOR.

a. **Description.** After the engine has reached operating temperature, the thermostat opens and allows the water to circulate through the radiator. The fan draws air through the radiator core and cools the hot water coming from the engine. The radiator core is bolted inside a shell and protected by the grill in front.

b. Trouble Shooting.

(1) **OVERHEATING.**

| Probable Cause | Probable Remedy |
|---|-------------------------------|
| Lack of water. | Fill radiator. |
| Radiator clogged. | Clean and flush. |
| Dirt, trash, or insects in radiator air passages. | Blow out with compressed air. |
| Rotted hoses. | Replace hoses. |

COOLING SYSTEM

(2) LOSS OF WATER.

| Probable Cause | Probable Remedy |
|--|----------------------------|
| Leaks in radiator core. | Notify ordnance personnel. |
| Radiator clogged so that water builds up in top tank and is lost through overflow. | Clean and flush. |

c. Maintenance. The cooling system should be flushed out periodically to remove accumulated loose rust or foreign material. This may be done with clean water or with SOLVENT, dry-cleaning, which is not injurious to steel, cast iron, or copper. Follow directions for flushing as given below.

(1) For flushing with clean water proceed as follows:

(a) Drain the cooling system and disconnect the water bypass tube at the thermostat housing (fig. 78).

(b) Remove the thermostat (par. 78).

(c) After the thermostat has been removed, bolt housing back to the water manifold, and reconnect the water bypass tube.

(d) System may now be flushed. Fill the cooling system; start the engine; then open both drain cocks and, using a hose, keep the radiator filled as the water runs through the system and drains out.

(e) When all the rust, etc., has been flushed from the system, stop the engine; install the thermostat; close the drains; and refill the system.

(2) If SOLVENT, dry-cleaning, is used to clean the cooling system, a different procedure should be followed:

(a) Drain the cooling system.

(b) Close the drains and fill the system with cleaning solution.

(c) Start the engine and run it for about an hour, regulating the radiator shutter to hold the engine temperature at 190 F.

(d) Drain the solution; flush radiator thoroughly, and refill.

(3) If trash or foreign material has gathered at the top of the tubes in the radiator core, back flushing of the radiator is necessary.

(a) Drain the cooling system and remove radiator cap.

(b) Disconnect the hose from the elbow in which the main drain cock is located.

(c) Insert a water hose inside this hose, and stuff a cloth around it if an adapter is not available for connection.

(d) Let water run slowly into radiator through hose until water runs out the top of radiator, then increase the water pressure.

(e) Run water through the radiator in this way long enough to force the obstructions off the top of the tubes and out the radiator filler pipe.

(f) Reconnect the lower hose and refill the cooling system.

HEAVY TRACTOR M1

78. THERMOSTAT.

a. **Description.** The thermostat is located at the front end of the water manifold and is designed to keep the operating temperature of the cooling fluid at 170 F. There is a ¼-inch pipe plug in the thermostat housing which must be removed whenever the cooling system is being refilled in order to prevent air locks in the cylinder head and block.

b. Trouble Shooting.

(1) ENGINE OVERHEATING.

| Probable Cause | Probable Remedy |
|-------------------------|---------------------|
| Thermostat not opening. | Replace thermostat. |

(2) ENGINE TEMPERATURE TOO LOW.

| | |
|--|---------------------|
| Thermostat defective and remaining open. | Replace thermostat. |
| Thermostat gasket defective. | Install new gasket. |

c. Removal.

SCREWDRIVER

WRENCH, open-end, ½-in.

WRENCH, socket, ½-in., with 6-in. extension

(1) DRAIN COOLING SYSTEM.

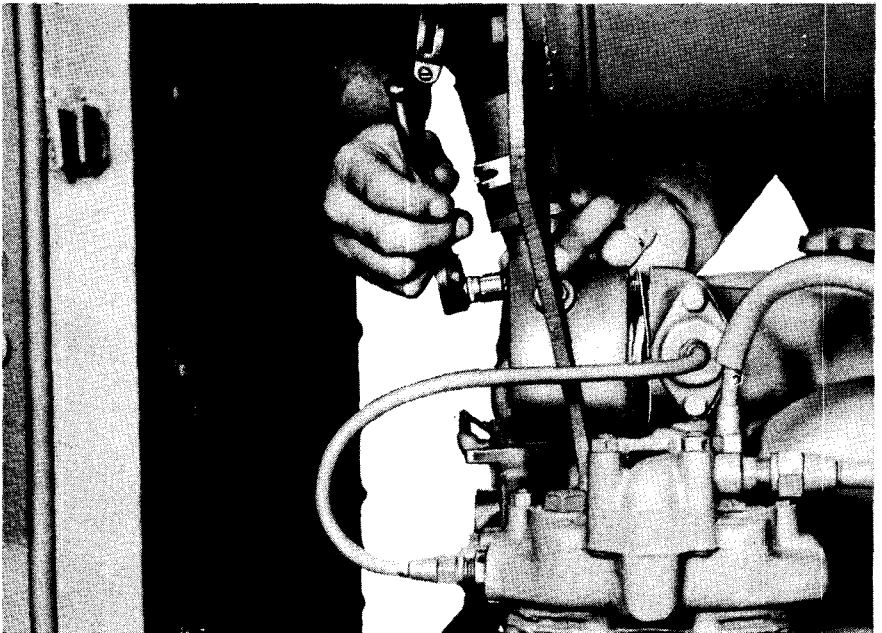

RA PD 17634

Figure 78—Removing Thermostat Assembly

COOLING SYSTEM

- (2) DISCONNECT RADIATOR HOSE.
SCREWDRIVER

Loosen clamp on hose connection.

- (3) DISCONNECT BYPASS TUBE.
WRENCH, socket, 1/2-in., with 6-in. extension

Remove two cap screws holding the bypass tube to the thermostat housing.

- (4) REMOVE THERMOSTAT HOUSING.
WRENCH, socket, 1/2-in., with 6-in. extension

Remove the three cap screws holding the housing to the water manifold.

- (5) REMOVE THERMOSTAT. Thermostat can now be slipped out of the thermostat housing.

d. Installation.

SCREWDRIVER

WRENCH, socket, 1/2-in., with
6-in. extension

SHELLAC

WRENCH, open-end, 1/2-in.

- (1) PLACE GASKET OVER THERMOSTAT.
(2) INSTALL THERMOSTAT. Place thermostat in housing taking care to keep gasket in place.

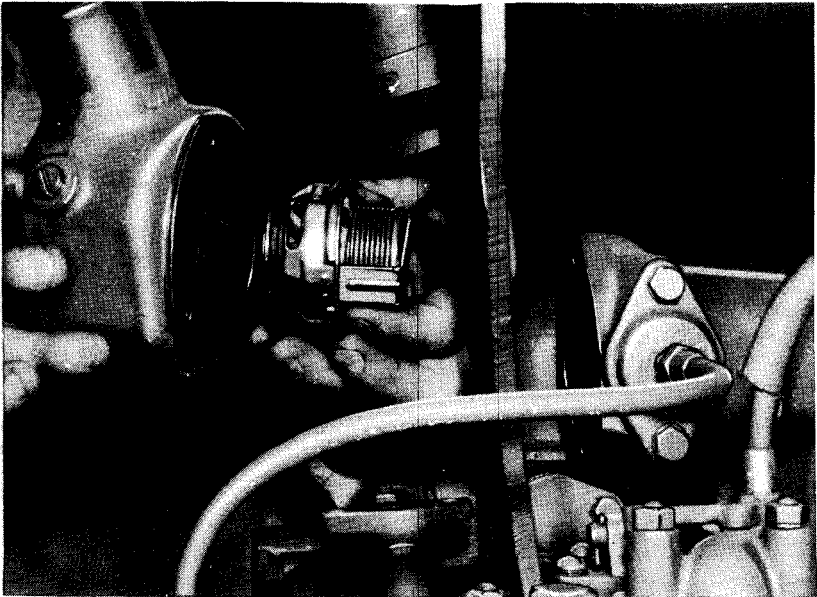

Figure 79—Installing Thermostat Assembly

RA PD 17635

HEAVY TRACTOR M1

(3) INSTALL GASKET ON HOUSING.

SHELLAC

Shellac new gasket to thermostat housing and coat other side of gasket with chassis grease.

(4) INSTALL ASSEMBLY TO HEAD.

WRENCH, socket, 1/2-in., with 6-in. extension

Hold assembly in place against head and tighten cap screws.

(5) CONNECT RADIATOR HOSE.

SCREWDRIVER

Shellac inside of hose, tighten clamp.

(6) CONNECT WATER BYPASS TUBE TO THERMOSTAT HOUSING.

WRENCH, socket, 1/2-in., with 6-in. extension

79. HOSES AND PIPES.

a. All hoses and connections should be inspected at regular intervals to see that hoses are in good condition and that all connections are tight.

b. If it becomes necessary to replace a hose the clamps should be loosened, hose removed, all connections shellacked, new hose installed, and clamps replaced and tightened.

80. FAN ASSEMBLY.

a. **Description.** The fan assembly is mounted on a bracket fastened to the balance weight housing on the front of the engine. The fan is driven by two V-belts from a pulley on the crankshaft. The six-blade fan is fastened to the pulley hub with four cap screws. Grease fitting is furnished in fan hub to lubricate bearings (sec. IV).

b. Trouble Shooting.

(1) ENGINE OVERHEATING.

Probable Cause

Drive belts loose.
Drive belts broken.

Probable Remedy

Adjust to 1 1/4-in. slack.
Replace belts.

(2) FAN NOISY.

Bearing defective.
Fan loose on hub.
Blades bent.

Replace fan assembly.
Tighten fan assembly.
Replace fan blade assembly.

c. Removal.

WRENCH, fan, 1-in.
WRENCH, open-end, 3/4-in.

WRENCH, socket, 1/2-in.
WRENCH, socket, 3/4-in.

COOLING SYSTEM

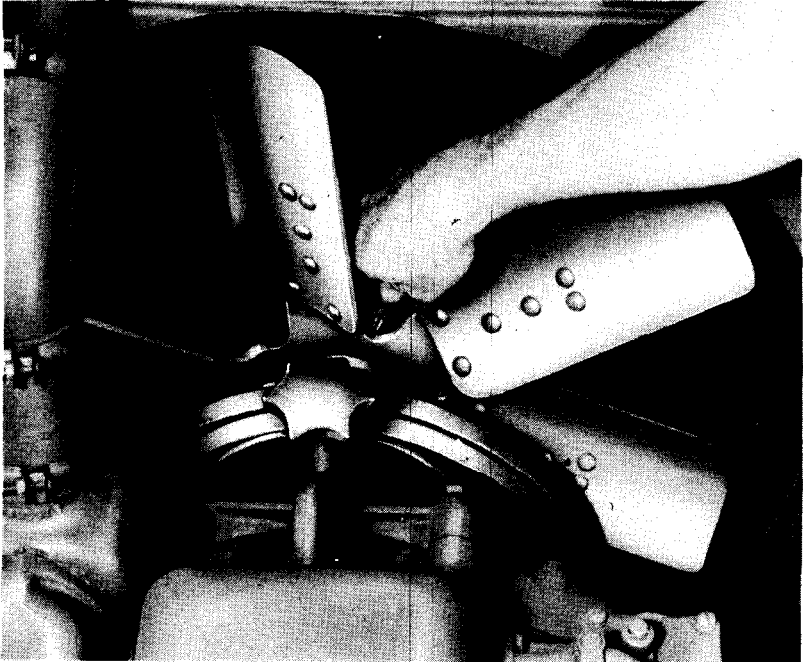

RA PD 17711

Figure 80—Removing Fan Blade Assembly

(1) REMOVE FAN BLADE ASSEMBLY.

WRENCH, socket, $\frac{1}{2}$ -in.

Remove fan blade assembly by removing four cap screws holding it to pulley.

(2) REMOVE ADJUSTING SCREW.

WRENCH, open-end, $\frac{3}{4}$ -in.

Loosen lock nut and turn adjusting screw from spindle and bracket.

(3) REMOVE PULLEY.

WRENCH, fan, 1-in.

Remove pulley by removing jam nut and washer from fan spindle.

(4) REMOVE BRACKET.

WRENCH, socket, $\frac{3}{4}$ -in.

Remove three cap screws and lock washers holding bracket to engine and remove bracket. NOTE: Fan blade assembly pulley, shaft, and bracket may be removed as a unit by performing this last step.

HEAVY TRACTOR M1

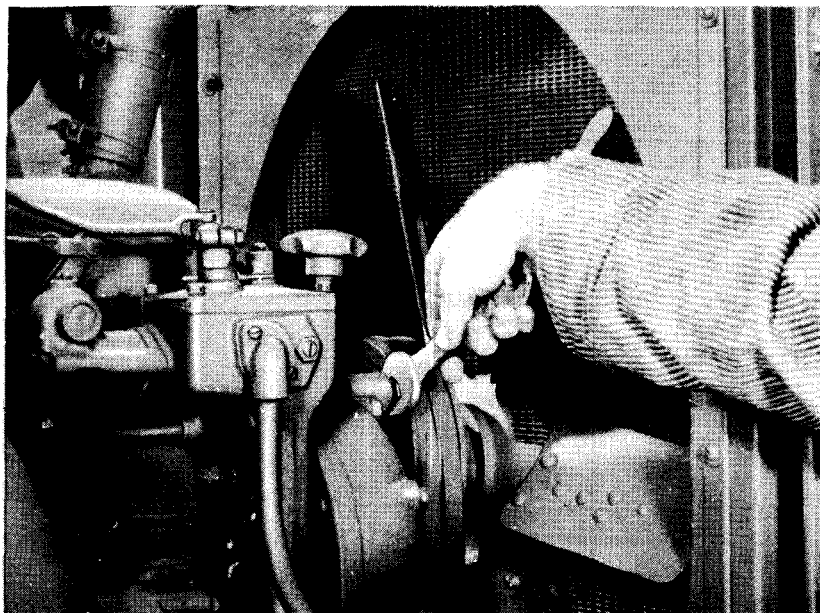

RA PD 17715

Figure 81—Removing Fan Assembly

d. Installation.

WRENCH, fan, 1-in.

WRENCH, socket, 1/2-in.

WRENCH, open-end, 3/4-in.

WRENCH, socket, 3/4-in.

(1) **INSTALL BRACKET.** Install bracket to engine with the three cap screws and lock washers.

(2) **INSTALL PULLEY.** Insert fan spindle through opening in bracket, place washer on fan spindle and start nut.

(3) **INSTALL ADJUSTING SCREW.**

WRENCH, open-end, 3/4-in.

With jam nut on screw insert screw through bracket and fan spindle.

(4) **INSTALL BELTS AND FAN BLADE ASSEMBLY.**

WRENCH, socket, 1/2-in.

Place belts in grooves of pulley. Then bolt fan blade assembly to pulley. Belts should now be adjusted.

COOLING SYSTEM

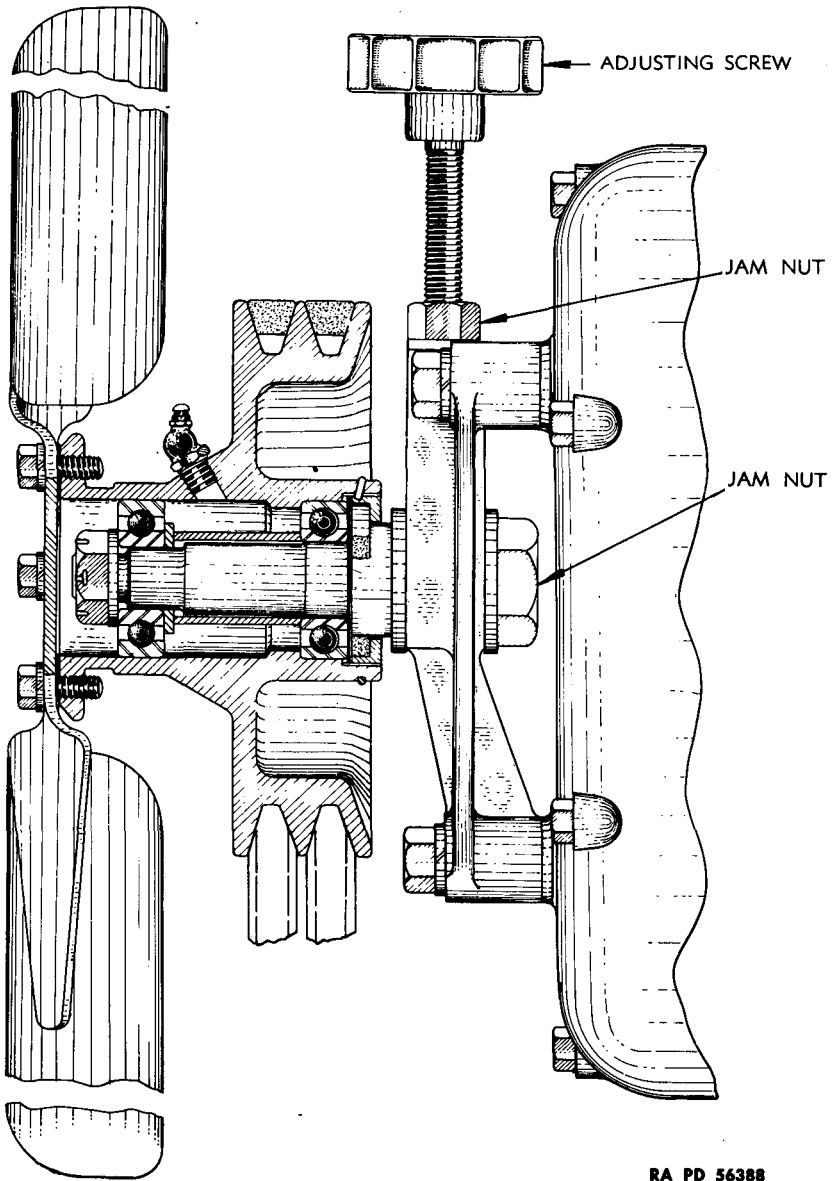

RA PD 56388

Figure 82—Fan Belt Adjustment
137

HEAVY TRACTOR M1**e. Fan Belt Adjustment.****WRENCH**, fan, 1-in.**WRENCH**, open-end, $\frac{3}{4}$ -in.

With jam nuts on adjusting screw and fan spindle loosened, turn adjusting screw clockwise to tighten belts. Belts are correctly adjusted when one side can be pressed towards the other side about $1\frac{1}{4}$ inch at point halfway between the pulleys. Tighten adjusting screw jam nut, and fan spindle jam nut.

f. Fan Belt Removal.**WRENCH**, fan, 1-in.**WRENCH**, open-end, $\frac{3}{4}$ -in.**(1) LOOSEN JAM NUT ON FAN SPINDLE.****WRENCH**, fan, 1-in.

Loosen the large nut in back of bracket on end of fan spindle.

(2) LOOSEN FAN BELTS.**WRENCH**, open-end, $\frac{3}{4}$ -in.

Loosen jam nut on adjusting screw and turn screw counterclockwise to loosen belts enough to remove them from belt pulley grooves.

(3) REMOVE BELTS. Remove one belt at a time. After removing belt from fan pulley, remove belt from lower crankshaft pulley and work belt off, over fan. Remove second belt in same manner.

g. Installation.**WRENCH**, fan, 1-in.**WRENCH**, open-end, $\frac{3}{4}$ -in.

(1) INSTALL BELTS. Work belts over fan. Place first belt in rear groove of lower crankshaft pulley first, then work belt onto fan pulley into rear groove. It may be necessary to turn fan by turning motor with engine cranking wrench to run belt onto fan pulley. Install second belt in front pulley grooves in same manner.

(2) ADJUST BELTS.**WRENCH**, open-end, $\frac{3}{4}$ -in.

Adjust belts as described under paragraph 80 e.

Section XIV

LUBRICATION SYSTEM

| | Paragraph |
|------------------|-----------|
| General | 81 |
| Oil pump | 82 |
| Oil filter | 83 |
| Oil cooler | 84 |

81. GENERAL.

a. The lubrication system for the engine consists of the oil pump, oil filter, and oil cooler. The engine block and head contain drilled passages to deliver oil, under pressure, to most of the moving parts of engine after passing through filter and cooler. The oil in returning to the sump flows through other parts and bearings to lubricate them. For proper lubricants and method of application see section IV.

82. OIL PUMP.

a. **Description.** The oil pump is a conventional gear type pump mounted to one of the engine main bearing caps and driven by the crankshaft through a chain and sprockets.

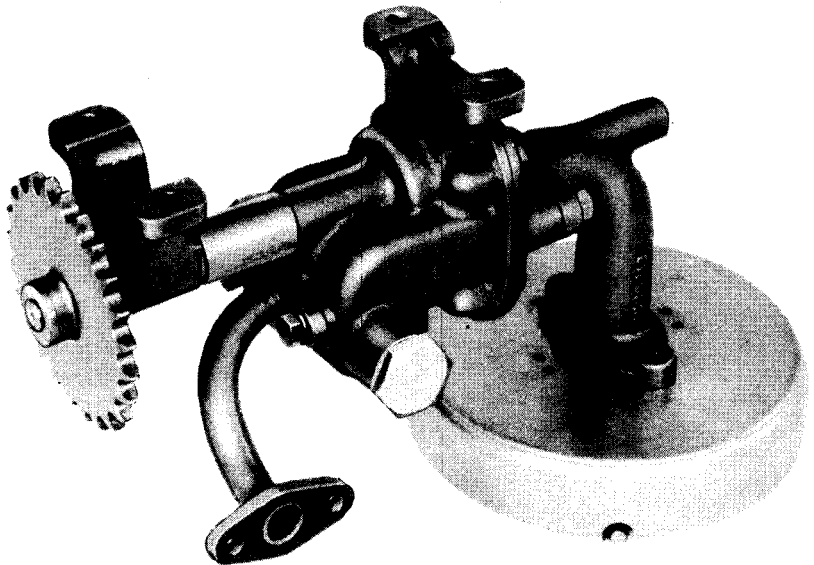

RA PD 17247

Figure 83—Lubricating Oil Pump

HEAVY TRACTOR M1

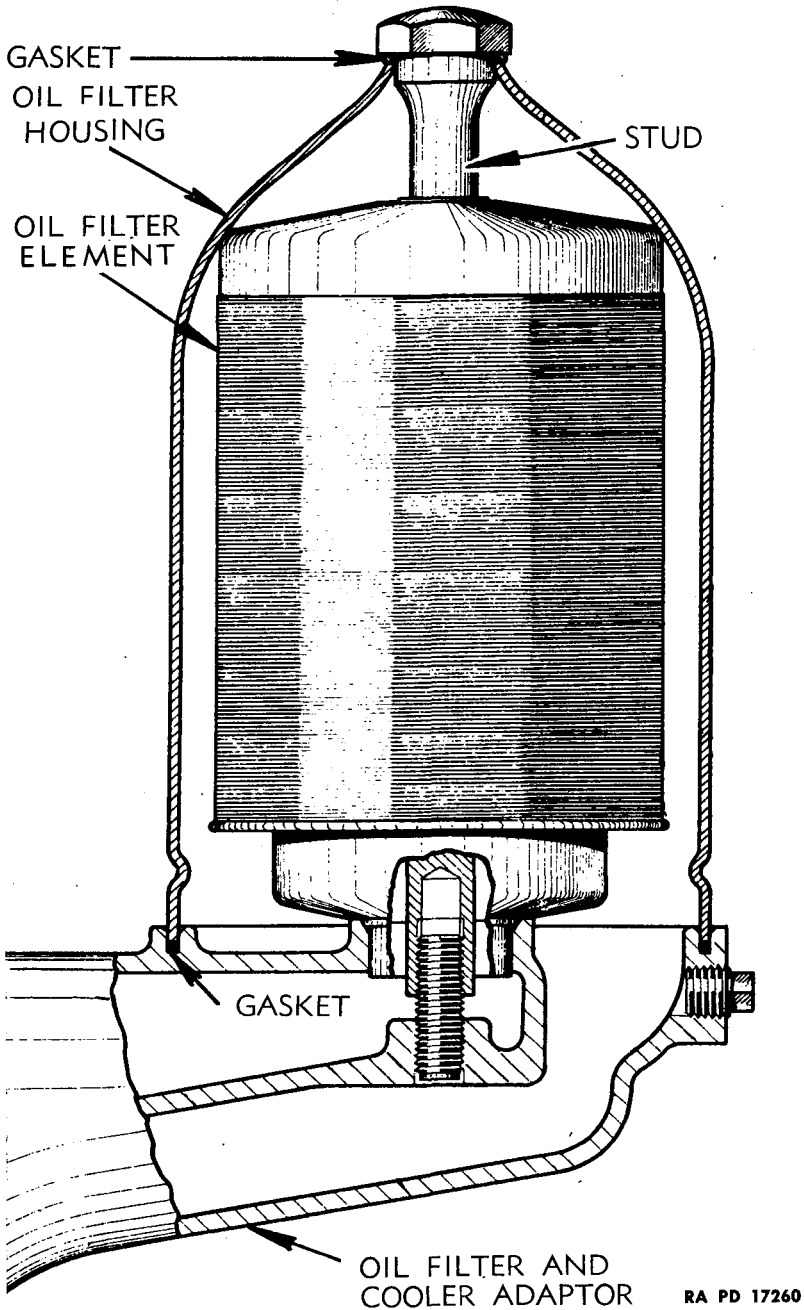

Figure 84—Cutaway View of Lubricating Oil Filter

LUBRICATION SYSTEM

b. **Maintenance.** No provision is made on the pump for increasing or decreasing oil pressure. If pressure is not within normal range of from 25 to 35 pounds at operating engine speed and temperature, stop the engine immediately and report to higher authority. The using arm will not attempt any maintenance on oil pump.

83. OIL FILTER.

a. **Description.** The oil filter, located on the front of engine, is of the full flow type and consists of two metal elements inside a housing. The bracket supporting the oil filter is cast with the adapter between oil cooler and engine block.

b. A sudden drop in oil pressure would indicate that this filter is plugged, possibly from sludge or dirt. Remove the filter and clean elements and base if this occurs.

c. **Removal.**

WRENCH, socket, 1 1/8-in.

WRENCH, square socket,
1/4-in.

(1) **REMOVE FILTER DRAIN PLUG.**

WRENCH, square socket,
1/4-in.

Remove plug at base of filter and allow oil to drain from filter.

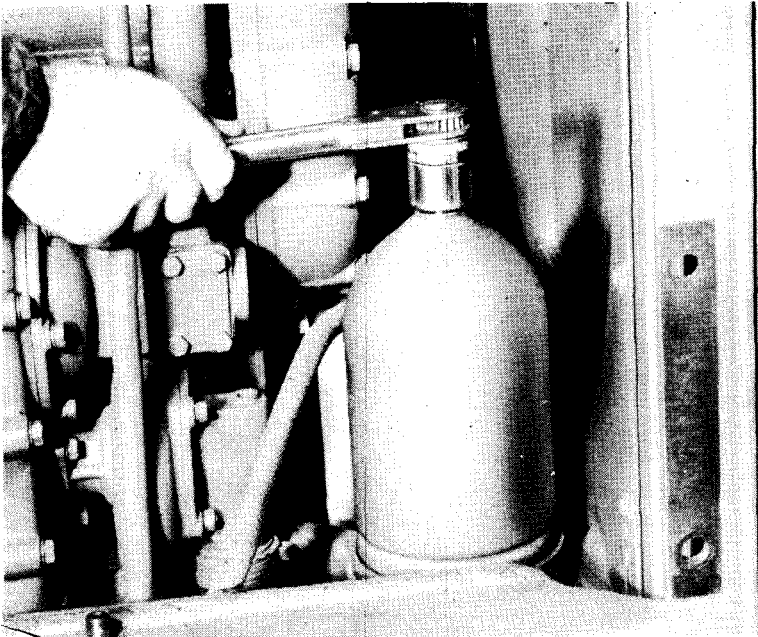

Figure 85—Removing Lubricating Oil Filter

RAPD 17605

HEAVY TRACTOR M1

(2) REMOVE OIL FILTER STUD.

WRENCH, socket, 1 1/8-in.

Remove stud and gasket and lift off filter housing and element.

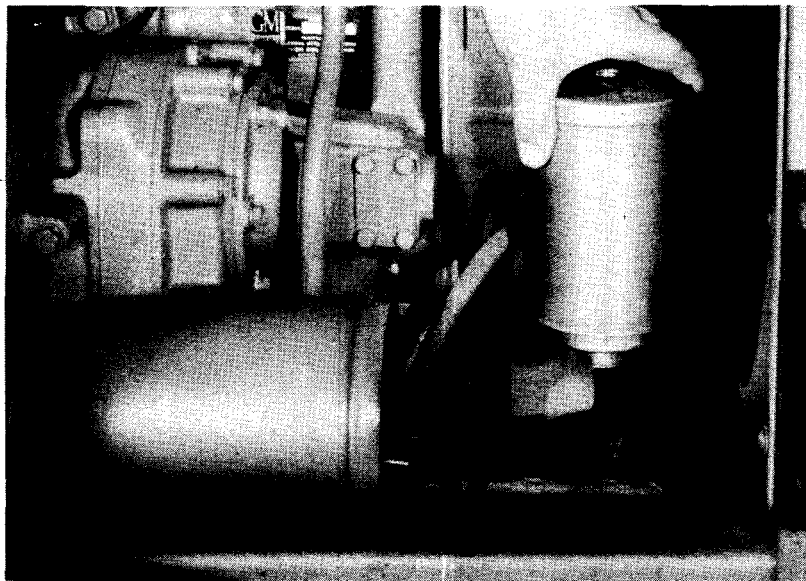

RA PD 17601

Figure 86—Removing Lubricating Oil Filter Element

d. Maintenance. The metal element in the filter should be removed and cleaned each time engine crankcase is drained and at any time between oil changes that low oil pressure may be due to clogged filter.

(1) Wash the element in clean fuel oil with a soft brush. Do not scrape with a sharp instrument or use a wire brush as damage may result.

(2) Wash all parts thoroughly, and dry them. Clean inside of filter adapter. Make sure gasket in base of filter is in good condition when filter is put back on tractor.

e. Installation.

WRENCH, socket, 1 1/8-in.

WRENCH, square socket,
1/4-in.

(1) **EXAMINE FILTER HOUSING GASKET.** Make sure that this gasket in base of filter is in good condition. If not, replace it.

(2) **SET ELEMENTS IN PLACE.** Assemble screens, one inside the other, and set them in adapter.

LUBRICATION SYSTEM

(3) INSTALL HOUSING AND DRAIN PLUG.

WRENCH, socket, 1 1/8-in.

WRENCH, square socket, 1/4-in.

Place housing over elements, making sure that bottom of housing enters groove in adapter. Install stud and gasket and tighten with 9-inch handle for wrench. Install filter drain plug.

(4) START ENGINE AND INSPECT FOR LEAKS.

84. OIL COOLER.

a. **Description.** The oil cooler assembly consists of a housing inside of which is a metal element somewhat similar to the core of a radiator. Water from the radiator circulates around element in the cooler and lubricating oil circulates through the element. The oil cooler plates are lined with small fins which dissipate heat from the oil inside the element to cooling water surrounding the element inside the cooler housing.

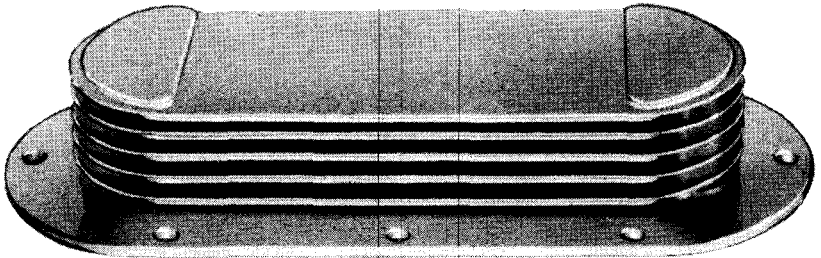

RA PD 17261

Figure 87—Oil Cooler Element

b. If proper lubricating oil maintenance procedure is followed, the cooler will function efficiently for an indefinite period. However, when oil is allowed to become laden with impurities, these impurities will deposit in the cooler; consequently causing clogging and inefficiency. To effectively clean the cooler, it is necessary to remove cooler element and circulate a special solvent through cooler element for some time by use of a force pump.

c. Removal.

SCREWDRIVER

WRENCH, socket, 3/4-in.

WRENCH, open-end, 1/2-in.

WRENCH, socket, 1 1/8-in.

WRENCH, open-end, 3/4-in.

WRENCH, square socket, 1/4-in.

WRENCH, socket, 9/16-in. with extension

(1) REMOVE RIGHT FRONT FENDER.

WRENCH, open-end, 3/4-in.

WRENCH, socket, 3/4-in.

Remove cap screw and bolts holding fender and remove fender.

HEAVY TRACTOR M1

(2) DRAIN COOLING SYSTEM AND OIL FILTER.

WRENCH, square socket, 1/4-in.

Drain cooling system and drain oil from filter by removing drain plug in adapter.

(3) REMOVE OIL FILTER.

WRENCH, socket, 1 1/8-in.

Remove filter housing and element by removing filter stud and gasket.

(4) DISCONNECT WATER BYPASS TUBE.

WRENCH, socket, 1/2-in.

Remove cap screw holding water bypass tube clip to cooler housing.

(5) REMOVE GOVERNOR BREATHER PIPE CLIP.

WRENCH, socket, 9/16-in.

Remove cap screw holding governor breather pipe clip to oil cooler.

(6) REMOVE ENGINE SUPPORT BOTTOM COVER.

WRENCH, socket, 9/16-in.

Remove cap screws holding cover to engine support and remove cover.

(7) DISCONNECT HOSES.

SCREWDRIVER

WRENCH, socket, 1/2-in., with short extension

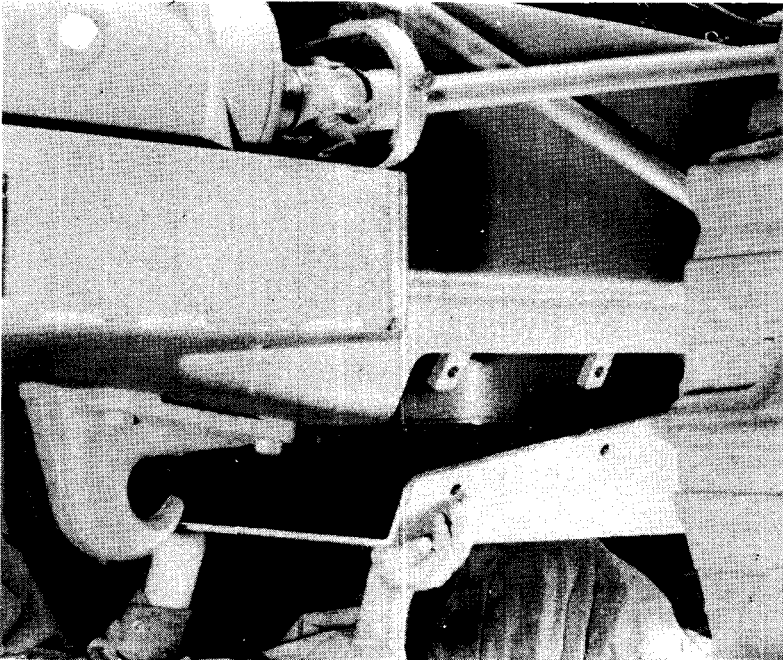

RA PD 17626

Figure 88—Removing Engine Support Bottom Cover

LUBRICATION SYSTEM

Loosen clamp on hose connecting water pump and oil cooler. Slip hose connection between water pump and cooler down onto cooler pipe. Remove two cap screws from lower water connection.

(8) REMOVE COOLER HOUSING.

WRENCH, socket, $\frac{9}{16}$ -in., with short extension

Remove the eight cap screws and lock washers holding cooler housing to oil filter and cooler adapter and remove housing and element.

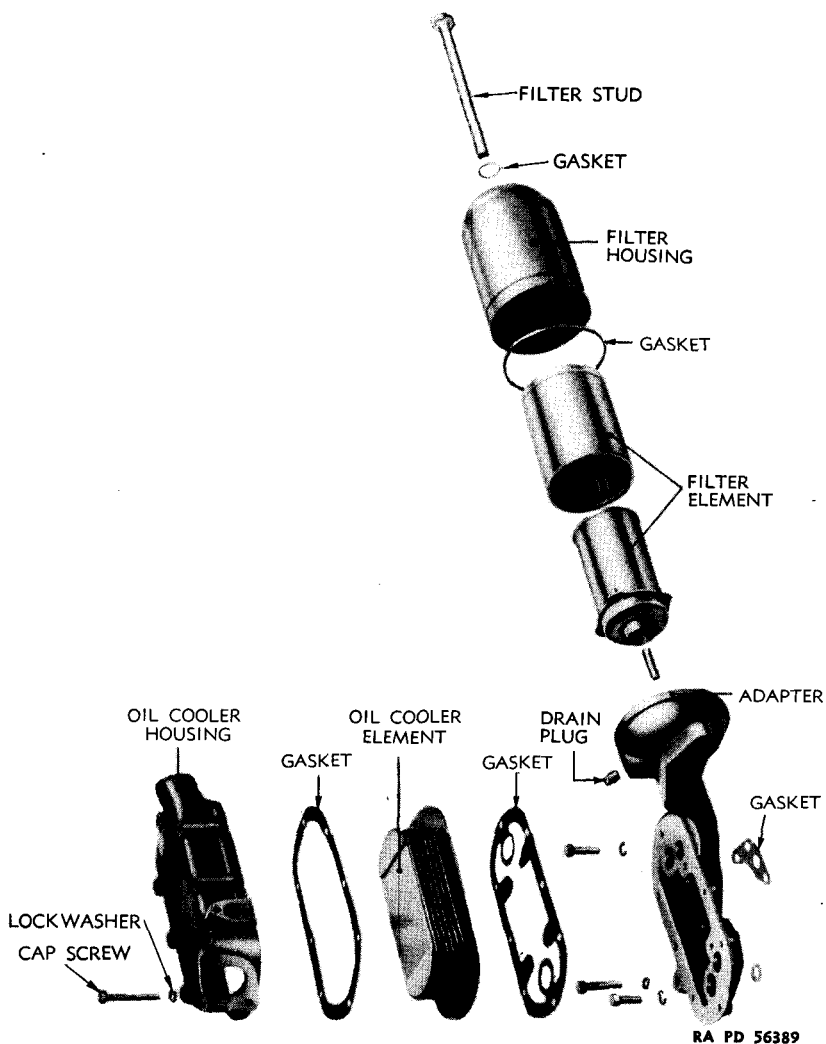

Figure 89—Lubricating Oil Filter and Cooler Assembly

HEAVY TRACTOR M1

d. Installation.

SCREWDRIVER

WRENCH, socket, $\frac{3}{4}$ -in.

SHELLAC

WRENCH, socket, $1\frac{1}{8}$ -in.

WRENCH, open-end, $\frac{1}{2}$ -in.

WRENCH, square socket, $\frac{1}{4}$ -in.

WRENCH, open-end, $\frac{3}{4}$ -in.

WRENCH, socket, $\frac{9}{16}$ -in.,
with extension

(1) **SHELLAC COOLER GASKETS.** Clean element housing and adapter surfaces and shellac both sides of cooler gasket.

(2) **INSTALL ELEMENT AND HOUSING.**

WRENCH, socket, $\frac{9}{16}$ -in., with extension

Place new element in housing and stick gasket to housing. Install assembly to engine with cap screws and lock washers.

(3) **INSTALL HOSES.**

SCREWDRIVER

WRENCH, socket, $\frac{1}{2}$ -in., with
extension

Connect hose at inlet of cooler and tighten clamp. Install cap screws in lower water connection and tighten, using a new gasket if necessary.

(4) **CONNECT WATER BYPASS TUBE.**

WRENCH, open-end, $\frac{1}{2}$ -in.

Shellac both sides of a new gasket and install gasket and water bypass tube to cooler.

(5) **INSTALL CAP SCREW HOLDING GOVERNOR BREATHER PIPE CLIP.**

WRENCH, socket, $\frac{9}{16}$ -in.

(6) **INSTALL OIL FILTER AND PLUG.**

WRENCH, socket, $1\frac{1}{8}$ -in.

WRENCH, square socket,
 $\frac{1}{4}$ -in.

Install filter and drain plug in adapter.

(7) **INSTALL FENDER.**

WRENCH, open-end, $\frac{3}{4}$ -in.

WRENCH, socket, $\frac{3}{4}$ -in.

Install fender with cap screw, bolts and lock washers.

(8) **START ENGINE AND INSPECT FOR LEAKS.** Fill system with water, start engine, and inspect all connections for leaks.

Section XV

ELECTRICAL SYSTEM AND EQUIPMENT

| | Paragraph |
|-----------------------------------|-----------|
| Description | 85 |
| Batteries | 86 |
| Generator | 87 |
| Generator voltage regulator | 88 |
| Starting motor | 89 |
| Ammeter | 90 |
| Hour meter | 91 |
| Air heater | 92 |
| Light switch | 93 |
| Panel light | 94 |
| Service lights | 95 |
| Wiring | 96 |

85. DESCRIPTION.

a. A 12-volt electrical system is used on the tractor. Two 6-volt batteries are connected in series. The capacity of the generator is sufficient to keep the batteries fully charged under normal operating conditions. **CAUTION:** Before working on any part of the electrical system first disconnect the battery ground cable. Do not reconnect the battery ground cable until all other equipment has been connected. This will prevent shorts and damage to the electrical units.

86. BATTERIES.

a. **Description.** The batteries are located under the seat. The positive cable is grounded to the transmission. The batteries supplied with the tractor are of two kinds and may be equipped with a "NO-OVER-FLO" device. This is a lead washer in each vent well which is designed to prevent overfilling.

b. Trouble Shooting.

(1) DISCHARGED BATTERY.

| Probable Cause | Probable Remedy |
|------------------------------------|---|
| Short circuits. | Locate and correct shorts. |
| Connections loose. | Tighten connections. |
| Connections dirty or corroded. | Clean connections and coat terminals with COMPOUND , rust-preventive, light. |
| Voltage control unit out of order. | Replace. |
| Generator not charging. | Check generator and control unit. |

HEAVY TRACTOR M1

(2) BATTERY OVERHEATING.

| Probable Cause | Probable Remedy |
|------------------------------------|----------------------------|
| Voltage control unit out of order. | Replace. |
| High charging rate. | Notify ordnance personnel. |

c. Removal.

SCREWDRIVER
 WRENCH, open-end, $\frac{9}{16}$ -in. WRENCH, socket, $\frac{9}{16}$ -in.

(1) REMOVE HOLD-DOWN ASSEMBLY.

WRENCH, socket, $\frac{9}{16}$ -in.

Remove hold-down assembly by removing the long cap screws which extend through equalizers to battery support.

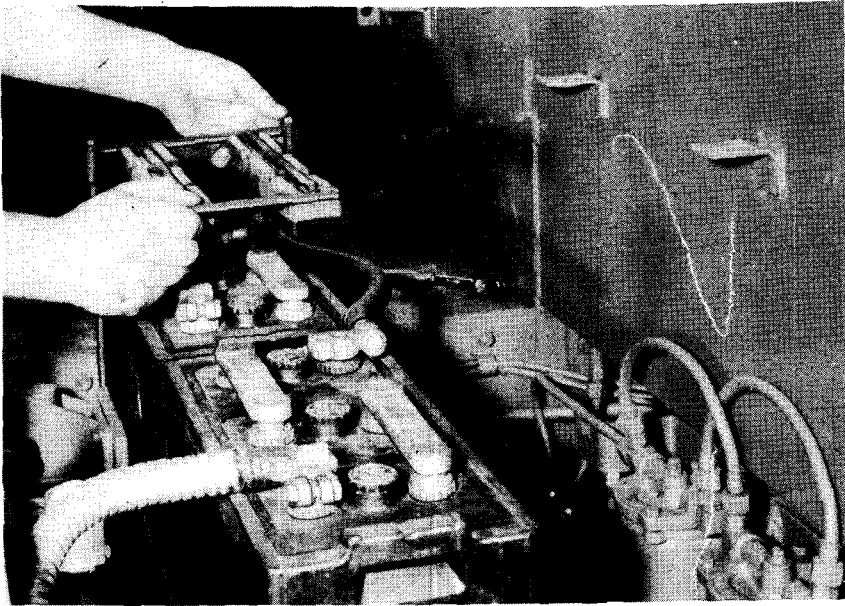

RA PD 17630

Figure 90—Removing Battery Hold-Down Assembly

(2) REMOVE CABLES FROM BATTERY TERMINALS.

WRENCH, open-end, $\frac{9}{16}$ -in.

Loosen bolts in clamps around battery terminals; spread clamps with screwdriver and lift them off battery terminals. **NOTE:** When necessary to tighten or loosen the clamped connections at the battery terminals, use a wrench of the proper size. Care must be taken that the wrench does not come in contact with any other metal parts of the

ELECTRICAL SYSTEM AND EQUIPMENT

battery or tractor. When removing terminals, remove grounded or positive terminal first, and when replacing terminals, replace grounded terminal last.

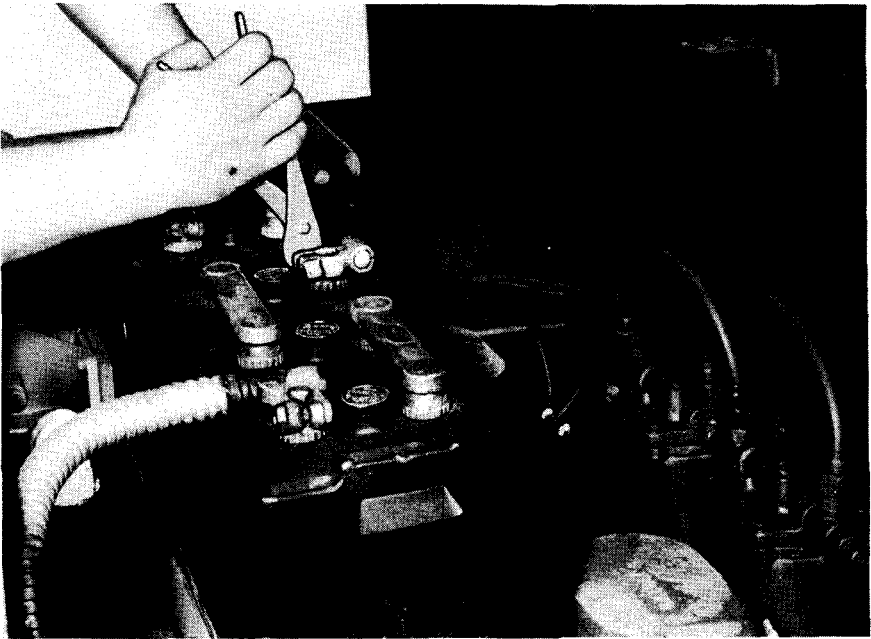

RA PD 17654

Figure 91—Removing Battery Cable

(3) **REMOVE BATTERIES.** Lift batteries out of support. Keep batteries right side up, and in handling be careful to keep batteries from touching clothes, as acid may drop on clothes. This acid will destroy any fabric it touches.

d. Maintenance.

(1) **SPECIFIC GRAVITY.** Specific gravity readings of each battery should be taken periodically. Use a hydrometer and test each cell separately. If readings are below 1.240, the battery is not receiving sufficient charge. (In zero weather there is danger of freezing if readings are below 1.175; a battery with a specific gravity reading of 1.225 will freeze at 35 degrees below zero F.) If water must be added oftener than every two weeks, the electrical system should be adjusted to decrease the charging rate. Otherwise the battery life will be shortened by overcharging.

HEAVY TRACTOR M1

(2) The electrolyte temperature affects the hydrometer reading. For each 30 F that the electrolyte is above 77 F, add 10 points to the hydrometer reading to get the true specific gravity. For each 30 F that the electrolyte is below 77 F, subtract 10 points from hydrometer reading to get true specific gravity. The above correction is tabulated in the following table for several electrolyte temperatures:

| ELECTROLYTE TEMPERATURE | CORRECTION TO OBTAIN TRUE SPECIFIC GRAVITY |
|-------------------------|--|
| + 122 F | Add 15 points |
| + 107 F | Add 10 points |
| + 92 F | Add 5 points |
| + 77 F | No correction |
| + 62 F | Subtract 5 points |
| + 47 F | " 10 points |
| + 32 F | " 15 points |
| + 17 F | " 20 points |
| + 2 F | " 25 points |
| - 13 F | " 30 points |
| - 43 F | " 40 points |

EXAMPLE

Hydrometer reads 1.250
 Electrolyte temperature 17 F
 True specific gravity = 1.250 minus 20 points
 True specific gravity = 1.230

When taking hydrometer readings on batteries equipped with "NO-OVERFLO," it will be necessary to return all electrolyte, withdrawn from battery for purpose of reading, by depressing the lead washer. **CAUTION:** This washer should be depressed only when returning electrolyte to cell and not when filling with water.

(3) ADDING WATER.

(a) If water is added in freezing temperature and battery is not charged to mix water with electrolyte, the water will remain on top and freeze. In a cold climate, water should be added when the battery is in a warm room so that the battery can be sufficiently charged to thoroughly mix the water with electrolyte before the water can freeze.

(b) Distilled water should be used.

(c) Do not overfill, as subsequent electrolyte expansion may cause flooding and damage. The proper filling height is approximately 3/8 inch above top of separators.

(d) The battery may be equipped with a lead washer in each vent well which is designed to prevent overfilling. Therefore, add water until it begins to rise into the vent plug well. Draw off any excess in order to obtain proper level when vent caps are in place.

(4) **VENT PLUGS.** Always keep vent plugs in place except when filling or taking gravity readings. Vent plugs must be in place while charging. Be sure hole in vent plug is open.

ELECTRICAL SYSTEM AND EQUIPMENT

(5) **KEEP BATTERIES CLEAN AND DRY.** If wet or dirty, wash with baking soda solution or ammonia, then with clear water. Be sure vent plugs are tight before washing.

(6) **TERMINALS.** Keep terminals tight and clean. If corroded, disconnect and clean (wash as in (5) above). Apply a thin coat of **COMPOUND**, rust-preventive, light, to terminal and battery posts before replacing terminal.

(7) **IDLE BATTERIES.** An idle battery requires a charge every month or two or at sufficient intervals to keep the gravity above 1.240.

(8) Temperatures at which electrolyte will freeze with various specific gravities are as follows:

| ACTUAL SPECIFIC GRAVITY | FREEZING TEMPERATURE |
|-------------------------|----------------------|
| 1.270 | — 96 F |
| 1.255 | — 60 F |
| 1.210 | — 31 F |
| 1.185 | — 8 F |
| 1.150 | + 5 F |
| 1.100 | + 18 F |

(9) The battery is in a hard rubber container. When working around the battery, remember that all its exposed metal parts are "alive" and that no metal, tool or wire should be laid across the terminals, as a spark or short circuit will result. Sparks and lighted matches or exposed flames should be avoided near the battery.

e. Installation.

WRENCH, open-end, $\frac{1}{16}$ -in.

WRENCH, socket, $\frac{1}{16}$ -in., with extension

(1) **CLEAN ALL CABLES AND CABLE TERMINALS.** Scrape off all dirt or corrosion. Coat cable and battery terminals with **COMPOUND**, rust-preventive, light.

(2) **INSTALL BATTERIES.**

WRENCH, open-end, $\frac{1}{16}$ -in.

Place batteries in position. Place large cable from starter switch on negative post of one battery, positive or ground cable on positive post of the other battery. Connect the two batteries with the connector cable.

(3) **INSTALL HOLD-DOWN ASSEMBLY.**

WRENCH, socket, $\frac{1}{16}$ -in. with extension.

The hold-down device used for securing the batteries in the tractors gives the battery protection against mechanical shaking, and vibration. It holds the battery by downward pressure on top of the cell connectors

HEAVY TRACTOR M1

and terminals instead of holding down on the rubber case. Care should be exercised in tightening the hold-down to guard against too much pressure being applied; also that the rubber lining of the hold-down bears on both the intercell connector (lead strips between cells) and terminal connectors. In replacing hold-down, check to see that cable connectors to batteries are tight; that the ungrounded terminals are clear of any metal part of the hold-down; and that the cables are not subject to rubbing which will wear off the insulation.

87. GENERATOR.

a. Description. The Delco-Remy generator, Model No. 1105380, is a $5\frac{1}{16}$ -inch 2-pole, third-brush, sealed-type unit, with ball bearings in each end to support the armature. It is used in connection with a Delco-Remy voltage regulator, Model No. 5888.

The purpose of the generator is to furnish electrical energy to the battery where it is stored. Energy drained from the battery is replaced by generator. The generator is driven by a V-belt from a pulley on the air compressor; the compressor in turn is driven by a V-belt from a pulley on the engine crankshaft.

b. Operation. Proper operation of the electrical system depends largely on a well-charged battery. The battery will be able to supply enough current to meet the needs of the system only if the generator is serviced regularly and checked at frequent intervals to determine if any adjustments or repairs are necessary. These adjustments or repairs will not be made by the using arm. Minor adjustments may be made without removing generator from tractor. The charging rate of the generator is set at from four to eight amperes when the tractor leaves the factory. This should be sufficient to keep the battery fully charged under ordinary operating conditions. The voltage regulator serves to prevent over-charging of the battery.

c. Lubrication. The two hinge cap oilers should be supplied with 8 to 10 drops of OIL, lubricating, engine, SAE 10, after every 64 hours of operation. Do not oil excessively. *Never oil commutator.*

d. Trouble Shooting.

(1) NOISY GENERATOR.

| Probable Cause | Probable Remedy |
|-----------------|----------------------------|
| Loose mounting. | Tighten mounting bolts. |
| Loose pulley. | Tighten pulley. |
| Worn bearings. | Notify ordnance personnel. |
| Dry bearings. | Lubricate. |

ELECTRICAL SYSTEM AND EQUIPMENT

(2) EXCESSIVE GENERATOR OUTPUT.

| Probable Cause | Probable Remedy |
|---|----------------------------|
| Generator field grounded. | Locate external ground. |
| Voltage control unit out of adjustment. | Notify ordnance personnel. |
| Voltage control unit defective. | Replace voltage regulator. |
| Commutator out of round. | Notify ordnance personnel. |
| Burned commutator bars. | Notify ordnance personnel. |

(3) NO GENERATOR OUTPUT.

| | |
|---|----------------------------|
| Burned commutator bars. | Notify ordnance personnel. |
| Worn brushes. | Notify ordnance personnel. |
| Sticking brushes. | Clean brushes. |
| Open or short circuit in field or armature. | Replace unit. |
| Loose belt. | Adjust for 1-inch slack. |

(4) LOW GENERATOR OUTPUT AND LOW BATTERY.

| | |
|--|----------------------------|
| Low brush tension. | Notify ordnance personnel. |
| Brushes sticking. | Clean brushes. |
| Rough, dirty, or greasy commutator bars. | Clean commutator bars. |
| High mica on commutator. | Notify ordnance personnel. |
| Loose belt. | Adjust to 1-inch slack. |

e. Quick Checks to Determine if Units Are Operating Normally.

(1) A fully charged battery and a low charging rate indicates normal operation.

(2) A fully charged battery and a high charging rate indicates faulty generator or voltage regulator operation. Disconnect the lead from the voltage regulator "F" terminal and if charging rate continues to be high, generator can be assumed to be at fault. Should the rate drop off completely, the voltage regulator is at fault.

(3) It must be remembered that even after the voltage regulator control has operated and inserted its resistance into the generator field circuit, it may still be possible for the generator to overcharge the battery. Under these conditions, it is desirable to reduce the generator output. Notify ordnance personnel.

(4) With a low battery and a low or no charging rate, momentarily ground the voltage regulator "F" terminal. This should normally cause the output to increase. If it does not, the generator will probably require repair, since it is apparently incapable of producing specified output. If the output does come up, the voltage regulator should be changed. Loose connections, defective wiring, or other causes of excessive resist-

HEAVY TRACTOR M1

ance in the charging circuit will cause the voltage regulator to operate and reduce the generator output even though the battery is still in a low state of charge.

f. Removal.**SCREWDRIVER****WRENCH**, open-end, 1/2-in.**WRENCH**, open-end, 5/8-in.**WRENCH**, open-end, 3/4-in.**WRENCH**, socket, 9/16-in., with extension**WRENCH**, socket, 3/4-in.**(1) REMOVE FRONT FENDER.****WRENCH**, open-end, 3/4-in.**WRENCH**, socket, 3/4-in.

Remove four bolts to remove fender. (fig. 76).

(2) REMOVE PREHEATER INTAKE ASSEMBLY.**WRENCH**, socket, 9/16-in., with extension

Open cover by loosening wing nuts, remove cap screw, and remove preheater intake assembly from engine.

(3) REMOVE WIRES.**SCREWDRIVER**

Remove screws to disconnect wires from generator and generator voltage regulator.

(4) REMOVE ADJUSTING SCREW.**WRENCH**, open-end, 1/2-in.

Remove cap screw in belt adjusting link.

(5) REMOVE GENERATOR.**WRENCH**, open-end, 5/8-in.

Remove the two cap screws holding generator to air compressor bracket and lift generator out of belt. Generator can now be taken out from under air compressor bracket.

g. Installation.**SCREWDRIVER****WRENCH**, open-end, 1/2-in.**WRENCH**, open-end, 9/16-in.**WRENCH**, open-end, 5/8-in.**WRENCH**, open-end, 3/4-in.**WRENCH**, socket, 9/16-in., with extension**WRENCH**, socket, 3/4-in.**(1) INSTALL GENERATOR ON BRACKET.****WRENCH**, open-end, 9/16-in.

Hold generator in place and install cap screws in air compressor bracket.

ELECTRICAL SYSTEM AND EQUIPMENT

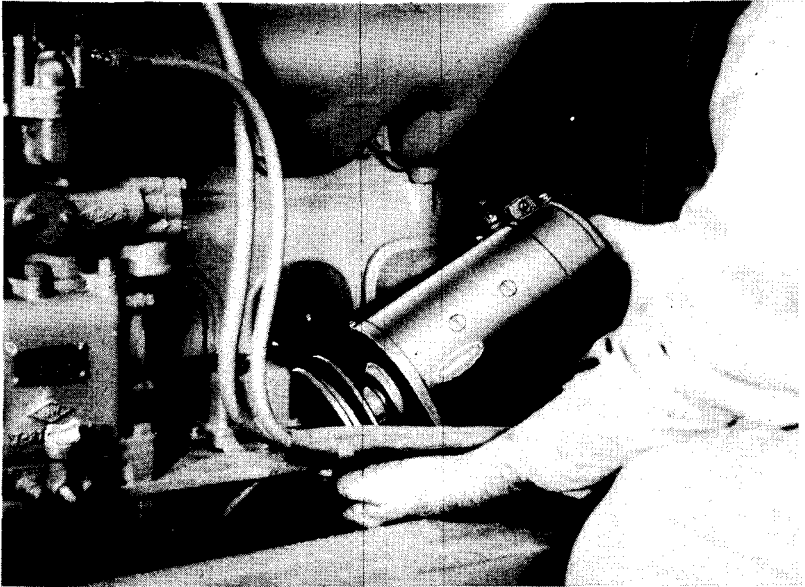

RAPD 17709

Figure 92—Removing Generator

(2) CONNECT WIRES.

SCREWDRIVER

Connect wires to generator and generator voltage regulator.

(3) INSTALL AND ADJUST BELT IN PULLEY.

WRENCH, open-end, 1/2-in.

Swing generator up and place drive belt in generator pulley. Install cap screw through washer and adjusting link into generator. Adjust belt to have from 3/4-inch to 1-inch slack measured halfway between pulleys. After the generator or control unit is reinstalled on the engine, or at any time after leads have been disconnected and then reconnected, a jumper lead should be connected, momentarily, between the battery and generator terminals of the voltage control unit *before starting the engine*. This allows a momentary surge of current from the battery to the generator which correctly polarizes the generator with respect to the battery it is to charge.

(4) INSTALL PREHEATER INTAKE ASSEMBLY.

WRENCH, socket, 9/16-in., with extension

Install new gasket on intake if old one is damaged; place assembly in its proper position; install cap screw and close cover. Tighten wing nuts.

HEAVY TRACTOR M1

(5) **INSTALL FENDER.**

WRENCH, open-end, $\frac{3}{4}$ -in.
Install fender with the four bolts.

WRENCH, socket, $\frac{3}{4}$ -in.

h. Generator Belt Removal.

BAR, pry, small
PLIERS
WRENCH, open-end, $\frac{1}{2}$ -in.

WRENCH, open-end, $\frac{3}{4}$ -in.
WRENCH, socket, $\frac{3}{4}$ -in.

(1) **REMOVE FRONT FENDER.**

WRENCH, open-end, $\frac{3}{4}$ -in.
Remove four bolts and remove fender.

WRENCH, socket, $\frac{3}{4}$ -in.

(2) **LOOSEN GENERATOR BELT.**

WRENCH, open-end, $\frac{1}{2}$ -in.
Loosen belt by loosening adjusting cap screw in adjusting link.

(3) **REMOVE AIR COMPRESSOR PULLEY.**

BAR, pry, small
PLIERS

WRENCH, open-end, $\frac{3}{4}$ -in.

Remove cotter pin and castellated nut holding drive pulley on compressor crankshaft. Pry pulley from shaft. Generator belt may now be removed.

i. Generator Belt Installation.

PLIERS
WRENCH, open-end, $\frac{1}{2}$ -in.

WRENCH, open-end, $\frac{3}{4}$ -in.
WRENCH, socket, $\frac{3}{4}$ -in.

(1) **INSTALL BELTS.** Place generator belt in inside groove of air compressor drive pulley. Install air compressor drive belt in outside groove of compressor pulley.

(2) **INSTALL AIR COMPRESSOR PULLEY.**

PLIERS

WRENCH, open-end, $\frac{3}{4}$ -in.

With drive belts in place, slide pulley on shaft with slot in shaft in line with key in shaft. Install castellated nut and cotter pin.

(3) **ADJUST GENERATOR BELT.**

WRENCH, open-end, $\frac{1}{2}$ -in.

(4) **INSTALL FENDER.**

WRENCH, open-end, $\frac{3}{4}$ -in.

WRENCH, socket, $\frac{3}{4}$ -in.

88. GENERATOR VOLTAGE REGULATOR.

a. Description. This assembly, mounted on the air compressor support bracket, consists of a voltage regulating mechanism and a cut-out relay, both mounted on the same metal base and under the same cover. This unit operates to decrease the maximum generator output

ELECTRICAL SYSTEM AND EQUIPMENT

when the battery approaches full charge. No adjustments of the generator voltage regulator should be attempted by the operating organization.

b. Removal.**SCREWDRIVER****WRENCH, open-end, $\frac{7}{16}$ -in.****(1) DISCONNECT WIRES.****SCREWDRIVER**

Remove screws holding the three wires to regulator terminals.

(2) REMOVE REGULATOR.**WRENCH, open-end, $\frac{7}{16}$ -in.**

Remove two cap screws holding regulator to air compressor bracket and lift off voltage regulator.

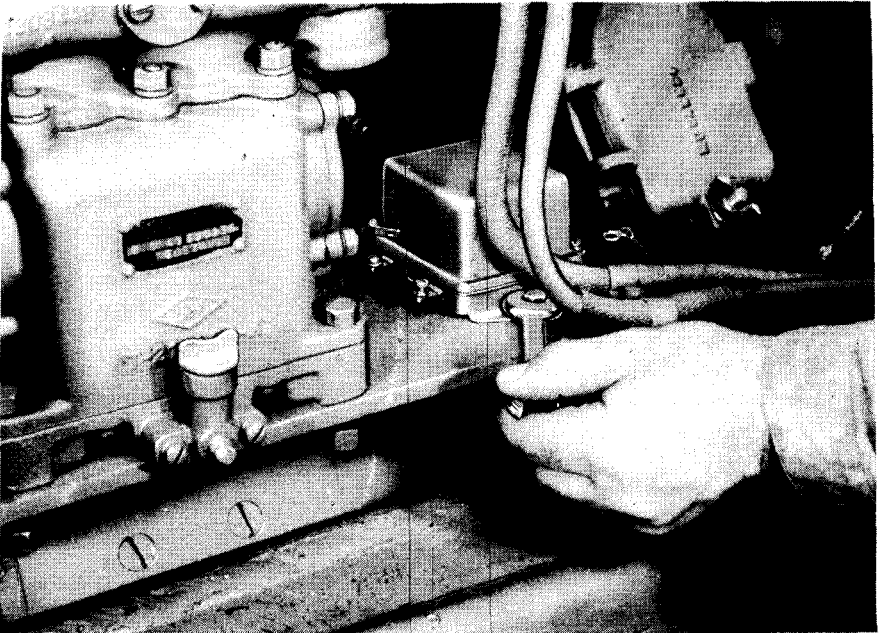

RA PD 17632

Figure 93—Removing Generator Voltage Regulator**c. Installation.****SCREWDRIVER****WRENCH, open-end, $\frac{7}{16}$ -in.****(1) INSTALL VOLTAGE REGULATOR UNIT.****WRENCH, open-end, $\frac{7}{16}$ -in.**

Set control unit in place on air compressor bracket and install cap screws.

HEAVY TRACTOR M1

(2) CONNECT WIRES.
SCREWDRIVER

Connect the three wires to the control unit terminals.

89. STARTING MOTOR.

a. **Description.** This is a Delco-Remy Model No. 1108714, 12-volt unit, heavy duty, with a Dyer drive operated by a shift lever on the motor.

b. **Lubrication.** The hinge cap oilers should be supplied with a few drops of OIL, lubricating, engine, SAE 10, after every 240 hours of operation.

c. Trouble Shooting.

(1) SLOW STARTING MOTOR SPEED.

| Probable Cause | Probable Remedy |
|-------------------------------|--------------------------------|
| Loose connections. | Tighten connections. |
| Dirty connections. | Clean connections. |
| Worn brushes. | Notify ordnance personnel. |
| Armature rubbing field coils. | Notify ordnance personnel. |
| Low battery voltage. | Check generator and regulator. |

(2) INOPERATIVE STARTING MOTOR.

| | |
|--|--------------------------------|
| Battery down. | Notify ordnance personnel. |
| Poor connections. | Clean and tighten connections. |
| Burned commutator bars. | Notify ordnance personnel. |
| Open or short circuits in field or armature. | Replace unit. |
| Defective starter switch. | Inspect contacts. |

d. If the starting motor does not develop rated torque, and cranks the engine slowly or not at all, check the battery, battery terminals and connections, and battery cables. Corroded, frayed, or broken cables should be replaced, and loose or dirty connections corrected. The starting motor switch should be checked for burned contacts and the switch contacts cleaned or replaced if necessary. Starting motor failure or faulty operation, if caused by other than loose and corroded terminals or minor adjustments, will not be corrected by the using arm personnel.

e. Removal.

| | |
|--|---|
| PLIERS | WRENCH, socket, $\frac{3}{4}$ -in. |
| WRENCH, open-end, $\frac{3}{4}$ -in. | WRENCH, socket, $\frac{7}{8}$ -in., with long extension |
| WRENCH, open-end, $1\frac{5}{16}$ -in. | |

(1) REMOVE FRONT FENDER.

WRENCH, open-end, $\frac{3}{4}$ -in. WRENCH, socket, $\frac{3}{4}$ -in.
Remove four bolts and remove fender.

ELECTRICAL SYSTEM AND EQUIPMENT

(2) DISCONNECT BATTERY CABLE.

WRENCH, open-end, $\frac{3}{4}$ -in.

Disconnect battery cable from starting motor. Tape the end of cable to prevent it from touching metal and shorting. Remove other wires on same post.

(3) DISCONNECT STARTING MOTOR ROD.

PLIERS

Remove pin from yoke of starting motor lever.

(4) REMOVE BOLTS HOLDING STARTING MOTOR.

WRENCH, open-end, $1\frac{5}{16}$ -in. WRENCH, socket, $\frac{7}{8}$ -in., with long extension

Remove the two cap screws and one bolt holding starting motor to flywheel housing.

(5) REMOVE STARTING MOTOR. Jar the starting motor loose by hand and remove starting motor from tractor.

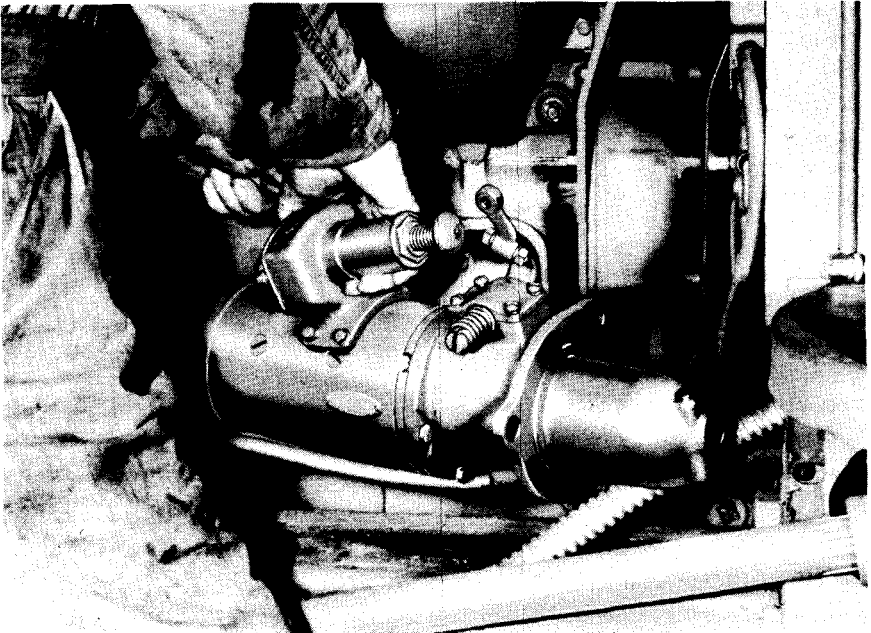

RA PD 17614

Figure 94—Removing Starting Motor

HEAVY TRACTOR M1

f. Installation.

PLIERS

WRENCH, open-end, $\frac{9}{16}$ -in.WRENCH, open-end, $\frac{3}{4}$ -in.WRENCH, open-end, $1\frac{5}{16}$ -in.WRENCH, socket, $\frac{3}{4}$ -in.WRENCH, socket, $\frac{7}{8}$ -in., with
long extension

(1) BOLT STARTER IN PLACE.

WRENCH, open-end, $1\frac{5}{16}$ -in.WRENCH, socket, $\frac{7}{8}$ -in., with
long extension

Clean off mounting flange of starting motor and housing; set starting motor in housing and bolt in place.

(2) INSTALL STARTING MOTOR ROD.

PLIERS

WRENCH, open-end, $\frac{9}{16}$ -in.

Connect starting motor rod on shift lever with pin. Adjust cap screw on shift lever as follows: Screw the adjusting cap screw in toward the lever so that the switch contacts do not touch when the lever is pushed all the way forward. Place the shifter lever in full forward position (the starting motor pinion will be against the stop). Back the cap screw out so that the switch contacts close. Pull the starting motor shift lever back and turn the adjusting screw out an additional two turns. Lock the nut.

(3) CONNECT BATTERY CABLE.

WRENCH, open-end, $\frac{3}{4}$ -in.

Connect battery cable, ammeter wire, and electric brake wire to starting motor switch post. Put on washer and nut and tighten.

90. AMMETER.

a. **Description.** The ammeter needle registers on the dial the amount of current being delivered to the battery when the engine and generator are running, or discharge from the battery when the engine is not running. If generator operation is normal, the needle swings towards the plus (+) side of the scale. When engine is not running, current used by electrical equipment discharges the battery and the needle swings towards the minus (-) side of the scale.

b. When the ammeter registers too high a charging rate (over eight amperes on plus side of scale) with the engine running at normal speed, generator or voltage regulator is not functioning properly. If it registers zero with the engine running at normal speed and no electrical equipment turned on, it indicates one of the following:

- (1) Batteries are fully charged—no correction necessary.

ELECTRICAL SYSTEM AND EQUIPMENT

(2) Generator is not working—check generator (par. 87); replace if necessary.

(3) Voltage control is inoperative—change voltage regulator.

(4) A wire may be loose or broken—inspect wiring.

(5) Ammeter may be faulty—replace ammeter.

c. Removal.

SCREWDRIVER

WRENCH, open-end, $\frac{3}{8}$ -in.

(1) REMOVE AMMETER FROM DASH PANEL.

SCREWDRIVER

Remove the three cross-recessed screws holding ammeter in panel and remove ammeter from panel.

(2) REMOVE WIRES.

WRENCH, open-end, $\frac{3}{8}$ -in.

Remove the six wires from two terminals on back of ammeter by removing the nuts and washers from terminals. Tag the wires so they may be reinstalled on the correct terminals of the new ammeter.

d. Installation.

SCREWDRIVER

WRENCH, open-end, $\frac{3}{8}$ -in.

(1) CONNECT WIRES.

WRENCH, open-end, $\frac{3}{8}$ -in.

Connect wires to new ammeter, placing the two wires on left-hand terminal and four wires on right-hand terminal. Tighten nuts.

(2) INSTALL AMMETER.

SCREWDRIVER

Set ammeter in panel and install the three cross-recessed screws.

(3) TEST AMMETER. Start engine and see that all electrical equipment operates properly.

91. HOUR METER.

a. **Description.** The engine hour meter is located on the dash to the right of the instrument panel and registers the total number of hours that the engine has operated. A pressure switch connected to the oil pressure gage is operated by pressure of the oil to the gage when engine is started. One wire from the pressure switch is connected to the hour meter and the other to the ammeter. A ground wire from the hour meter is connected to the temperature gage. Paragraph 25 gives instructions on how to read the hour meter.

b. If the hour meter becomes inoperative, it may be due to either a faulty pressure switch or to the meter itself. Check for broken wires and

HEAVY TRACTOR M1

loose connections before replacing either. Do not attempt any repair of either the switch or hour meter. Check the pressure switch first by removing the two wires from the terminals of the switch and connecting the two ends. If the hour meter begins to operate immediately, the pressure switch should be replaced. If it does not, the hour meter should be replaced.

c. Removal.**PLIERS****WRENCH, open-end, $\frac{9}{16}$ -in.****SCREWDRIVER****(1) REMOVE PANEL FROM DASH.****SCREWDRIVER**

Remove the four cross-recessed screws holding panel to dash and pull panel out of dash carefully.

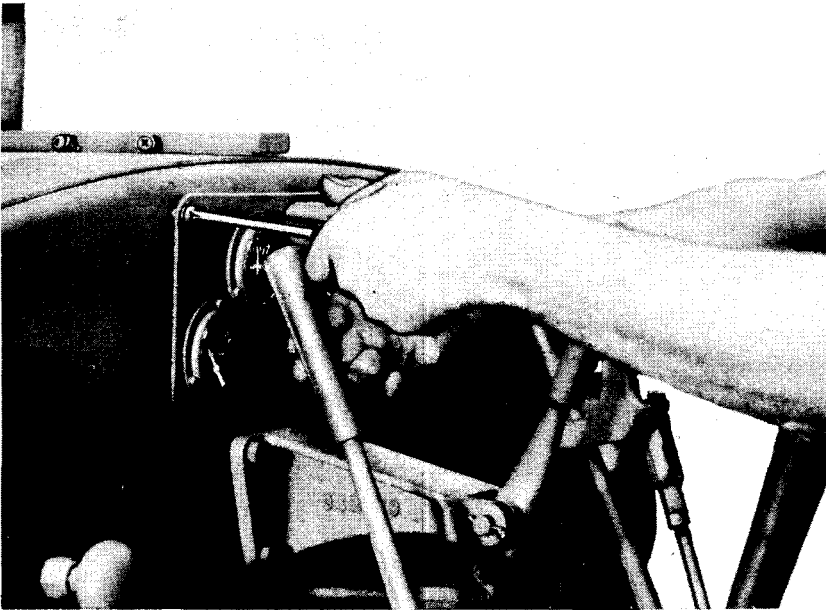

RA PD 17602

Figure 95—Removing Screws from Instrument Panel

(2) DISCONNECT WIRES.**SCREWDRIVER**

Disconnect the wire leading from the hour meter to temperature gage. Remove the wire seal and cover from the pressure switch and disconnect the wire leading from pressure switch to hour meter.

ELECTRICAL SYSTEM AND EQUIPMENT

(3) REMOVE HOUR METER.

SCREWDRIVER

Remove the three cross-recessed screws holding the hour meter to dash and remove hour meter.

(4) REMOVE PRESSURE SWITCH.

WRENCH, open-end, $\frac{9}{16}$ -in.

Disconnect wire leading from pressure switch to ammeter, hold elbow with pliers, and unscrew pressure switch from the side outlet elbow.

d. Installation.

PERMATEX or white lead

SCREWDRIVER

PLIERS

WRENCH, open-end, $\frac{9}{16}$ -in.

(1) INSTALL PRESSURE SWITCH

WRENCH, open-end, $\frac{9}{16}$ -in.

Coat threads of pressure switch with permatex or white lead and screw into side outlet elbow tightly.

(2) INSTALL HOUR METER.

SCREWDRIVER

Place hour meter in hole in dash and secure with the three cross-recessed screws.

(3) CONNECT WIRES.

SCREWDRIVER

Connect the short wire on hour meter to one terminal of pressure switch. Connect the long wire to temperature gage. Connect the wire from the ammeter to other terminal of pressure switch. Install cover on switch and install seal wire.

(4) INSTALL INSTRUMENT PANEL.

SCREWDRIVER

Place panel back in dash and secure with the four cross-recessed screws.

(5) TEST FOR OPERATION. Start engine and watch small hand at top left of dial of hour meter. As soon as oil pressure rises to five pounds, this hand should start to rotate.

92. AIR HEATER.

a. **Description.** The air heater is essentially a small, pressure oil burner with electric ignition. The burner proper is mounted in the engine air box and obtains the necessary air for combustion from the blower. The flame-heated air is discharged directly into the engine

HEAVY TRACTOR M1

cylinders. The air heater consists of two assemblies; one unit comprises the pressure pump mounted on the dash, and the other unit consists of a burner nozzle, filter, ignition coil, and ignition points. The air heater replaces one of the hand hole cover plates nearest the center of the engine. The hand pump on the dash supplies fuel under pressure to the burner unit where it is ignited as it is sprayed through the nozzle. A button switch on dash is used when air heater is to be operated. For operation of the air heater, refer to paragraph 11.

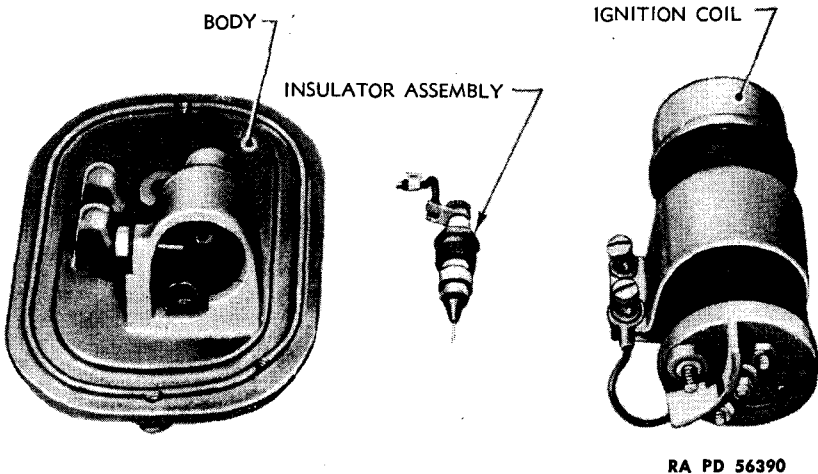

RA PD 56390

Figure 96—Air Heater Parts

b. The vibrator in the air heater should buzz when the button switch is depressed. If no buzz can be heard, it is an indication that no current is being supplied to the coil or the vibrator points are stuck or burned. A unit that fails to arc at the electrodes may often be made to operate by cleaning and drying the electrodes.

c. Removal of Air Heater Burner Unit.

WRENCH, open-end, $\frac{3}{8}$ -in.

WRENCH, open-end, $\frac{7}{16}$ -in.

WRENCH, socket, $\frac{1}{2}$ -in.

WRENCH, socket, $\frac{9}{16}$ -in., with extension.

(1) DISCONNECT FUEL LINE.

WRENCH, open-end, $\frac{7}{16}$ -in.

Disconnect fuel line at rear of check valve.

(2) REMOVE COVER.

WRENCH, socket, $\frac{1}{2}$ -in.

Remove the two cap screws holding cover to unit and remove cover.

ELECTRICAL SYSTEM AND EQUIPMENT

(3) **DISCONNECT WIRE FROM COIL.**

WRENCH, open-end, $\frac{3}{8}$ -in.

Disconnect the wire leading from air heater switch to coil.

(4) **REMOVE AIR HEATER BODY.**

WRENCH, socket, $\frac{9}{16}$ -in. with extension

Remove the special cap screw holding burner unit and remove air heater body.

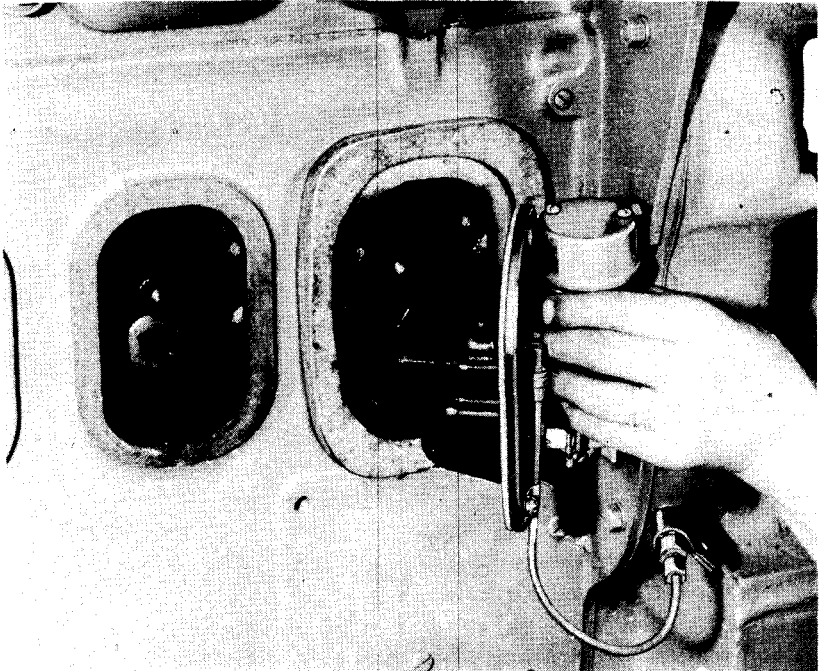

RA PD 17639

Figure 97—Removing Air Heater Burner Unit

d. Installation of Air Heater Burner Unit.

WRENCH, open-end, $\frac{3}{8}$ -in.

WRENCH, socket, $\frac{9}{16}$ -in., with extension

WRENCH, open-end, $\frac{7}{16}$ -in.

WRENCH, socket, $\frac{1}{2}$ -in.

(1) **INSTALL BODY.** Clean off all old gaskets and use new ones. Install unit in place with the special cap screw.

(2) **CONNECT WIRE TO COIL.**

WRENCH, open-end, $\frac{3}{8}$ -in.

HEAVY TRACTOR M1

(3) INSTALL COVER.

WRENCH, socket, 1/2-in.

Use a new felt gasket, if necessary, and bolt cover in place with the two cap screws. Install lower cap screw through clip holding fuel line check valve.

(4) CONNECT FUEL LINE.

WRENCH, open-end, 7/16-in.

Connect the fuel line to rear of check valve.

e. Removal of Air Heater Pump Assembly.

PLIERS

WRENCH, open-end, 5/8-in.

WRENCH, open-end, 7/16-in.

WRENCH, open-end, 7/8-in.

WRENCH, open-end, 9/16-in.

WRENCH, open-end, 15/16-in.

(1) CLOSE FUEL SHUT-OFF VALVE AT TANK.

(2) DISCONNECT FUEL LINES.

WRENCH, open-end, 7/16-in.

WRENCH, open-end, 5/8-in.

WRENCH, open-end, 9/16-in.

WRENCH, open-end, 7/8-in.

Disconnect both intake and discharge lines from pump.

(3) REMOVE PUMP PLUNGER AND PUMP BODY.

PLIERS

WRENCH, open-end, 7/8-in.

Hold the pump to keep it from turning, removing the pump plunger nut and pull pump plunger from pump body. Pump body may now be pushed out to rear of dash.

f. Installation of Air Heater Pump Assembly.

PLIERS

WRENCH, open-end, 5/8-in.

WRENCH, open-end, 7/16-in.

WRENCH, open-end, 7/8-in.

WRENCH, open-end, 9/16-in.

WRENCH, open-end, 15/16-in.

(1) INSTALL PUMP BODY. Remove the pump plunger nut from replacement assembly and pull plunger out. Screw jam nut back on threads as far as possible. Place the threaded end of pump body through dash from inside.

(2) INSTALL PLUNGER.

PLIERS

WRENCH, open-end, 15/16-in.

WRENCH, open-end, 7/8-in.

Soften the pump plunger leathers with OIL, lubricating, engine, SAE 10, and carefully enter the plunger into the pump body so that the leathers are not damaged. Tighten the pump plunger nut; then tighten jam nut against inside of dash.

ELECTRICAL SYSTEM AND EQUIPMENT

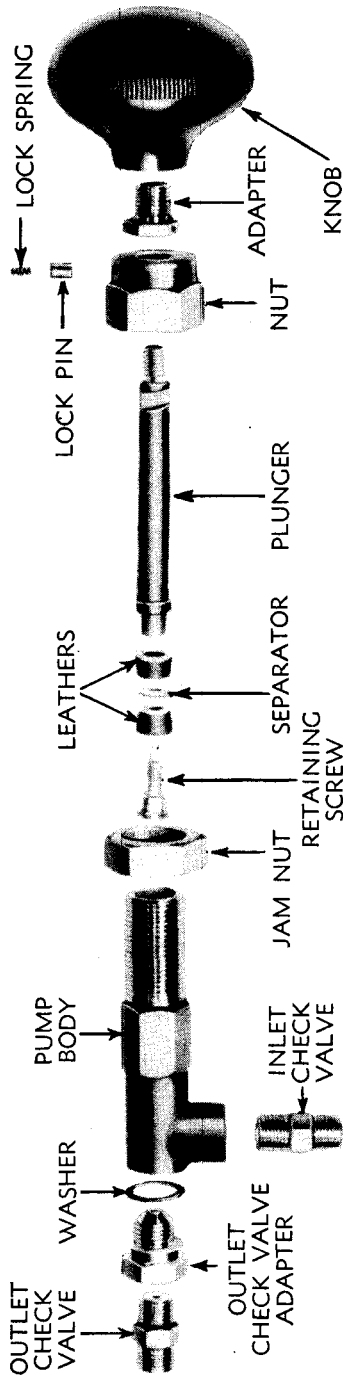

RA PD 40851

Figure 98 — Air Heater Pump—Exploded View

HEAVY TRACTOR M1

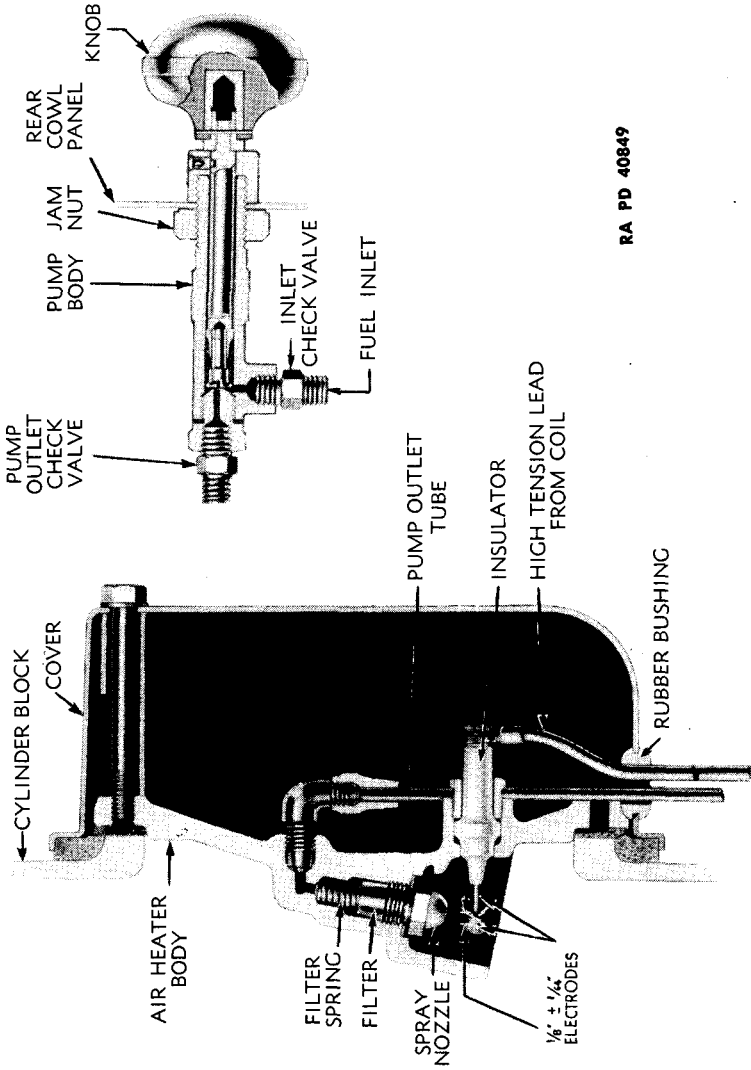

RA PD 40849

Figure 99 — Cross Sectional View of Air Heater Pump

ELECTRICAL SYSTEM AND EQUIPMENT

(3) CONNECT FUEL LINES.

WRENCH, open-end, $\frac{7}{16}$ -in.

WRENCH, open-end, $\frac{5}{8}$ -in.

WRENCH, open-end, $\frac{9}{16}$ -in.

WRENCH, open-end, $\frac{7}{8}$ -in.

Connect intake and discharge fuel lines; open the fuel shut-off valve and operate the pump a few times to make sure it operates properly and does not leak.

g. Removal of Air Heater Switch.

PLIERS

SCREWDRIVER

(1) REMOVE SWITCH FROM DASH.

PLIERS

Hold the switch body to keep it from turning; remove the round knurled lock nut that is tight against dash, and remove switch from dash.

(2) REMOVE WIRES.

SCREWDRIVER

Disconnect the wires from the switch by removing the two screws holding them.

h. Installation of Air Heater Switch.

PLIERS

WRENCH, open-end, $\frac{3}{4}$ -in.

SCREWDRIVER

(1) INSTALL WIRES ON SWITCH.

SCREWDRIVER

Connect the two wires to the switch with the two screws.

(2) INSTALL SWITCH.

PLIERS

WRENCH, open-end, $\frac{3}{4}$ -in.

Insert the threaded end of switch through the hole in dash with button towards operator, and tighten in place with the knurled nut. Tighten jam nut.

93. LIGHT SWITCH.

a. Description. The light switch is of the push-pull type with a spring stop to control its three positions. It may be pulled out to the first position (blackout lights) without depressing the latch button. For the other two positions (service lights and service stop light), the latch button must be depressed to pull switch out.

b. Removal.

PLIERS

WRENCH, open-end, $\frac{1}{2}$ -in.

SCREWDRIVER

WRENCH, open-end, $\frac{3}{4}$ -in.

(1) REMOVE SWITCH KNOB.

PLIERS

SCREWDRIVER

Loosen set screw in knob and unscrew knob from shaft.

HEAVY TRACTOR M1

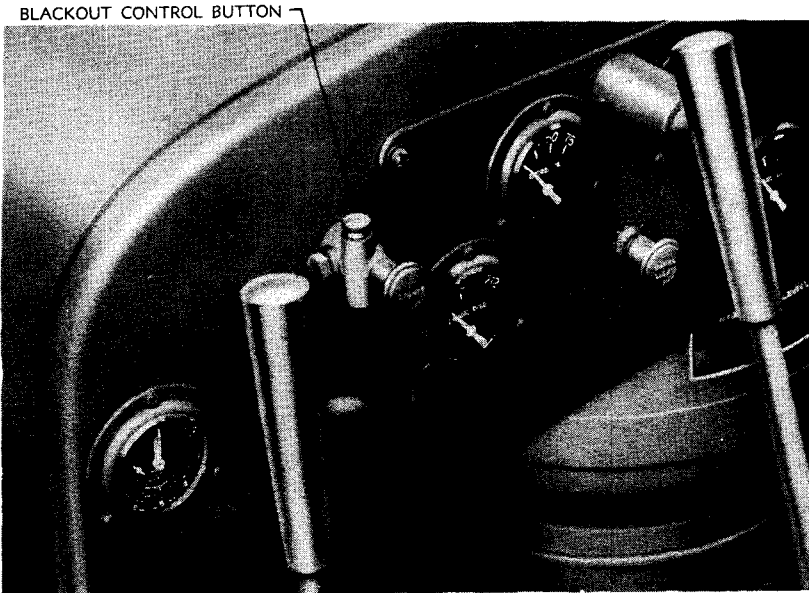

RA PD 56395

Figure 100—Blackout Control on Light Switch

(2) REMOVE BLACKOUT CONTROL ASSEMBLY.

WRENCH, open-end, 1/2-in.

Remove lock screw from side of blackout control assembly; depress button and pull assembly from dash.

(3) REMOVE SWITCH.

WRENCH, open-end, 3/4-in.

Remove switch mounting nut and pull light switch assembly from dash.

(4) REMOVE WIRES.

SCREWDRIVER

Remove wires by removing the screws from terminals on switch. Tag wires for identification.

c. Installation.

PLIERS

SCREWDRIVER

WRENCH, open-end, 1/2-in.

WRENCH, open-end, 3/4-in.

(1) CONNECT WIRES TO SWITCH.

SCREWDRIVER

Place wires on terminals according to tags on wires or refer to wiring diagram (fig. 105).

ELECTRICAL SYSTEM AND EQUIPMENT

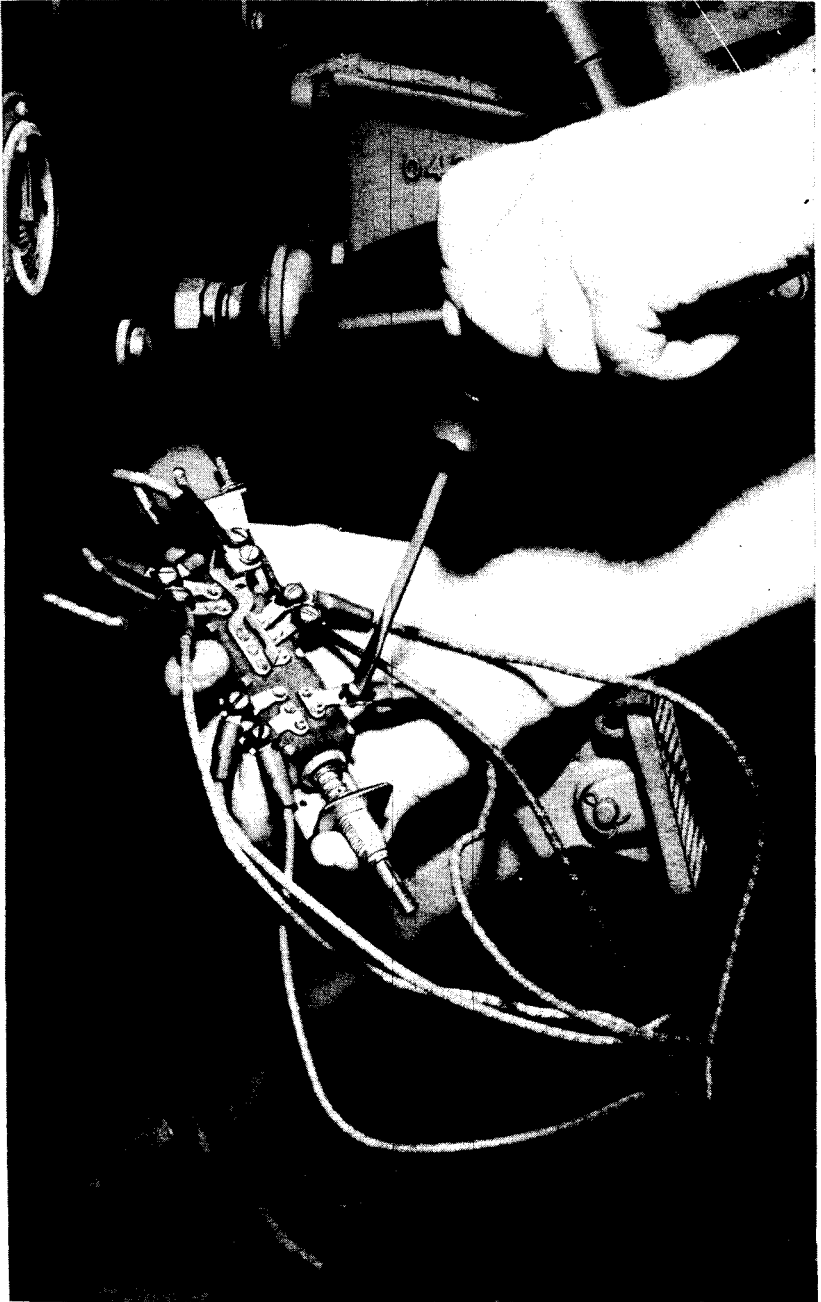

Figure 101—Removing Light Switch
171

HEAVY TRACTOR M1

(2) INSTALL SWITCH IN DASH.

WRENCH, open-end, 3/4-in.

Insert shaft of switch through dash with shaft towards operator. Install mounting nut and lock washer; tighten. Notches on shaft should be to the left.

(3) INSTALL BLACKOUT CONTROL ASSEMBLY.

WRENCH, open-end, 1/2-in.

Slip blackout control assembly on shaft, holding latch button down. Latch button should point up. Hold assembly against dash; place lock washer on lock screw; install and tighten.

(4) INSTALL KNOB.

PLIERS

SCREWDRIVER

Screw knob tight on shaft and tighten set screw.

94. PANEL LIGHT.

a. General. The panel light is similar to those ordinarily used on cars and trucks. It is mounted on the instrument panel in dash and is controlled by a separate push-pull type switch. The panel light throws sufficient light on the operating instruments to make them easily read during night operation. The main light switch must be pulled out before panel light will turn on.

b. Removal of Panel Light Bulb.

SCREWDRIVER

(1) REMOVE SHIELD.

SCREWDRIVER

Remove the two screws holding shield to bracket and pull off shield. Glass inside of shield will come off with shield.

(2) REMOVE BULB.

Push in slightly on bulb and turn it to the left. Bulb can now be pulled out of socket.

c. Installation of Panel Light Bulb.

SCREWDRIVER

(1) INSTALL BULB.

Insert bulb in socket with bulb turned so that the two points on bulb coincide with the two slots in socket. Push bulb in far enough so that the two points may be turned to the right into locking notches.

(2) INSTALL SHIELD.

SCREWDRIVER

Be sure rubber ring is in place. Push shield on, around bracket, and install the two screws.

ELECTRICAL SYSTEM AND EQUIPMENT**95. SERVICE LIGHTS.**

a. **Description.** The lighting system is 12-volt throughout with the exception of the panel light. Headlights are mounted one on each side of radiator and are protected with guards. Small blackout lamps are mounted to top of headlight guards. Some tractors in the field are not equipped with blackout lights. Blackout lights will be provided for them as soon as possible. Rear lights are combined stop and taillights and blackout lights. The trailer brake control system is wired so that the lights on trailer work in conjunction with tractor lights. Lights are controlled by main light switch (par. 93).

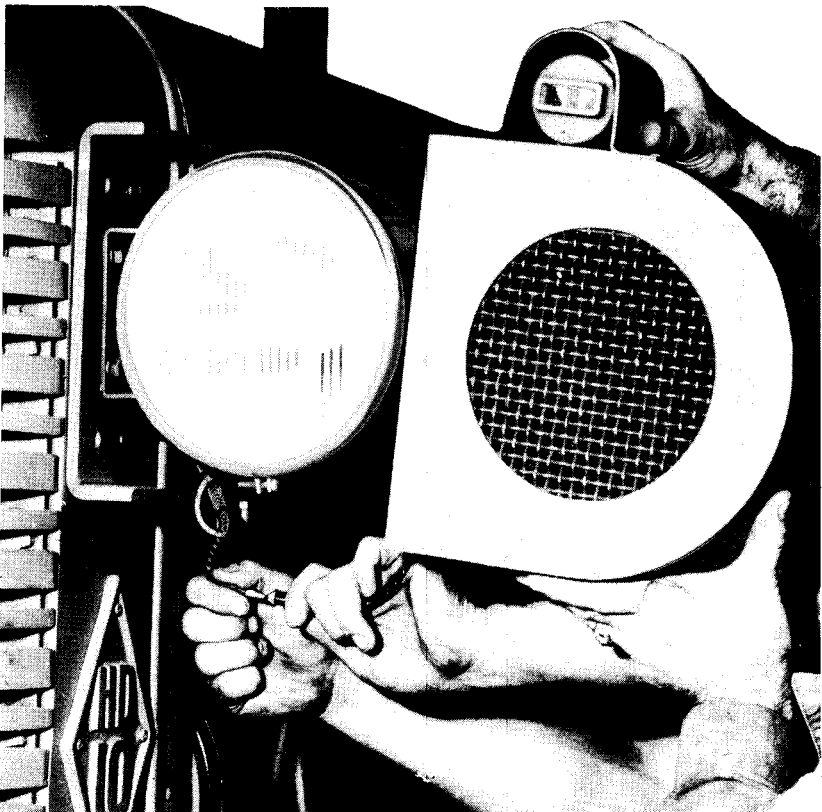
b. Removal of Headlight and Bulb.**SCREWDRIVER****WRENCH, socket, $\frac{3}{16}$ -in.****WRENCH, socket, $\frac{3}{4}$ -in.**

RA PD 17269

Figure 102—Removing Headlight Guard

HEAVY TRACTOR M1

(1) REMOVE GUARD.

WRENCH, socket, $\frac{3}{4}$ -in.

Remove guard by removing four cap screws holding guard to brackets on radiator shell. Blackout lights are fastened to guard. Pull wire to blackout light from socket as guard is removed.

(2) REMOVE HEADLIGHT.

WRENCH, socket, $\frac{9}{16}$ -in.

Unscrew retaining nut and remove wire from bottom of headlight. Remove two cap screws holding light to radiator shell and remove headlight.

(3) REMOVE BULB.

SCREWDRIVER

Loosen screw in clamp around lens and remove clamp moulding assembly and lens. Push in on bulb, turn bulb to left and pull out bulb.

NOTE: Omit second step if only bulb is to be removed.

c. Installation of Headlight and Bulb.

SCREWDRIVER.

WRENCH, socket, $\frac{3}{4}$ -in.

WRENCH, socket, $\frac{9}{16}$ -in.

(1) INSTALL BULB.

Insert a 12-volt, 32 cp-bulb in socket. Push bulb in and turn it to right into locking notches.

(2) INSTALL LENS.

SCREWDRIVER

With lens in clamp moulding assembly, work clamp onto headlight and tighten screw in clamp.

(3) INSTALL HEADLIGHT.

WRENCH, socket, $\frac{9}{16}$ -in.

Hold headlight against radiator shell and install cap screws. Connect headlight wire by inserting plug on end of wire in socket of headlight and screw retaining nut on socket.

(4) INSTALL GUARD.

WRENCH, socket, $\frac{3}{4}$ -in.

Hold guard close to headlight and plug blackout light wire into connector. Place guard over headlight and on the brackets on radiator shell and install cap screws.

d. Removal of Blackout Light and Bulb.

SCREWDRIVER

WRENCH, socket, $\frac{9}{16}$ -in.

WRENCH, open-end, $\frac{1}{2}$ -in.

WRENCH, socket, $\frac{3}{4}$ -in.

WRENCH, open-end, $\frac{9}{16}$ -in.

ELECTRICAL SYSTEM AND EQUIPMENT

(1) REMOVE HEADLIGHT GUARD.

WRENCH, socket, $\frac{3}{4}$ -in.

Remove four cap screws holding guard to brackets on radiator shell and remove guard. Pull blackout light wire from connector as guard is removed.

(2) REMOVE BLACKOUT LIGHT GUARD FROM HEADLIGHT GUARD.

WRENCH, open-end, $\frac{9}{16}$ -in. WRENCH, socket, $\frac{9}{16}$ -in.

Remove bolt from blackout light guard and headlight guard and remove blackout light guard.

(3) REMOVE BLACKOUT LIGHT.

WRENCH, open-end, $\frac{1}{2}$ -in.

Remove nut holding blackout light on headlight guard and slip it off, over wire. Remove blackout light from guard.

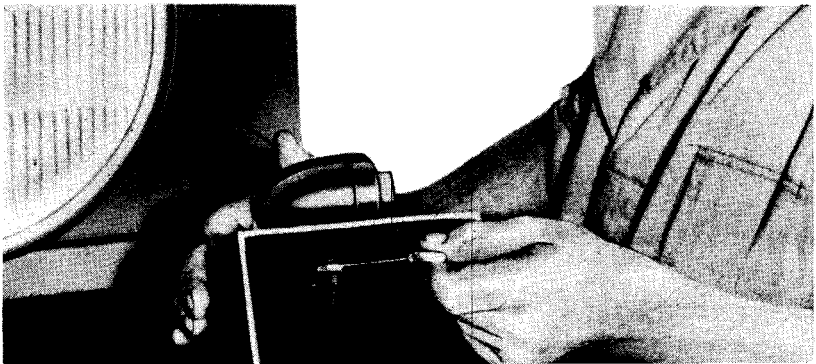

HEAVY TRACTOR M1

e. Installation of Blackout Light and Bulb.

SCREWDRIVER

WRENCH, socket, $\frac{9}{16}$ -in.

WRENCH, open-end, $\frac{1}{2}$ -in.

WRENCH, socket, $\frac{3}{4}$ -in.

WRENCH, open-end, $\frac{9}{16}$ -in.

(1) INSTALL BULB.

Insert bulb in socket of light. Push bulb in far enough to engage in locking notches and turn bulb to the right.

(2) INSTALL LENS.

SCREWDRIVER

Place lens on light and secure with screw.

(3) INSTALL LIGHT.

WRENCH, open-end, $\frac{1}{2}$ -in.

Insert wire and threaded part of light assembly through hole in headlight guard, install nut, and tighten.

(4) INSTALL GUARD.

WRENCH, open-end, $\frac{9}{16}$ -in.

WRENCH, socket, $\frac{9}{16}$ -in.

Place blackout light guard on headlight guard and install outside bolt.

(5) INSTALL ASSEMBLY ON TRACTOR.

WRENCH, socket, $\frac{3}{4}$ -in.

Insert blackout light wire into connector and bolt headlight assembly to tractor.

f. Removal of Rear Lamp Assembly.

SCREWDRIVER

WRENCH, open-end, $\frac{9}{16}$ -in.

WRENCH, open-end, $\frac{1}{2}$ -in.

WRENCH, socket, $\frac{9}{16}$ -in.

(1) DISCONNECT WIRES.

Slip rubber boots off connections at rear of lamp, turn the plugs and pull them from their sockets.

(2) REMOVE LAMP.

WRENCH, open-end, $\frac{1}{2}$ -in.

Remove the two nuts holding lamp to guard bracket and remove lamp from bracket.

(3) REMOVE BRACKET.

WRENCH, open-end, $\frac{9}{16}$ -in.

WRENCH, socket, $\frac{9}{16}$ -in.

Remove four bolts holding lamp guard to rear street plate box and remove guard. **NOTE:** Replacement of lamp assembly requires only first two steps.

(4) REMOVE INDIVIDUAL LIGHTS.

SCREWDRIVER

Remove two screws holding rim of light, remove rim and pull lights from sockets. **NOTE:** To replace either light, it is necessary to perform this step only.

ELECTRICAL SYSTEM AND EQUIPMENT

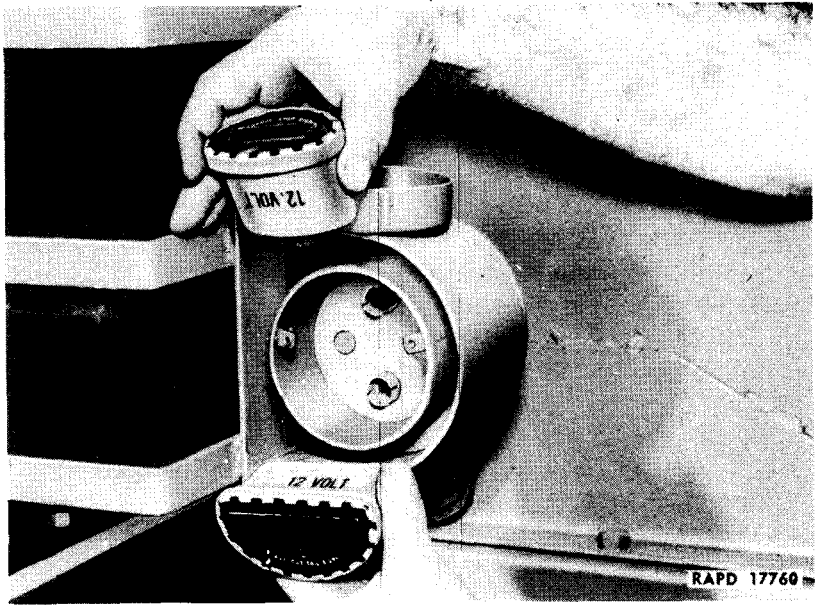

Figure 104—Removing Lights from Rear Lamp

g. Installation of Rear Lamp Assembly.

SCREWDRIVER

WRENCH, open-end, $\frac{1}{16}$ -in.

WRENCH, open-end, $\frac{1}{2}$ -in.

WRENCH, socket, $\frac{1}{16}$ -in.

(1) INSTALL LIGHTS.

SCREWDRIVER

Insert lights in their respective sockets and install rim and screws.

(2) INSTALL LAMP IN GUARD.

WRENCH, open-end, $\frac{1}{2}$ -in.

Insert bolts at rear of lamp through holes in guard and install and tighten nuts.

(3) INSTALL ASSEMBLY TO BOX.

WRENCH, open-end, $\frac{1}{16}$ -in.

WRENCH, socket, $\frac{1}{16}$ -in.

Hold assembly against end of street plate box. Install bolts and tighten them.

(4) CONNECT WIRES.

Insert plugs on ends of wires in sockets. Push them in far enough so that plugs can be turned to engage in locking notches. **NOTE:** The plug with two wires should be installed in upper socket of left lamp. Slip rubber boots over connections.

HEAVY TRACTOR M1

h. Stop Light Switch. This is a lever-type switch bolted underneath floor plate and is operated by the master clutch lever. When clutch lever is pushed forward to release the clutch, the lower end of the lever actuates stop light switch lever and stop light is lighted.

(1) REMOVAL.

SCREWDRIVER

WRENCH, socket, $\frac{1}{16}$ -in.

WRENCH, open-end, $\frac{1}{16}$ -in.

(a) Remove Switch from Floor Plate.

WRENCH, open-end, $\frac{1}{16}$ -in.

WRENCH, socket, $\frac{1}{16}$ -in.

Remove the two bolts from which switch is suspended. These bolts are those just back of the rear end of slot in floor plate in which master clutch lever works. Switch can now be lifted up through clutch lever slot.

(b) Remove Wires from Switch.

SCREWDRIVER

Remove two screws holding wires to switch. Tape wires as they are removed.

(2) INSTALLATION.

SCREWDRIVER

WRENCH, socket, $\frac{1}{16}$ -in.

WRENCH, open-end, $\frac{1}{16}$ -in.

(a) Connect Wires to Switch.

SCREWDRIVER

Connect one wire to each terminal of switch with screws.

(b) Install Switch.

WRENCH, open-end, $\frac{1}{16}$ -in.

WRENCH, socket, $\frac{1}{16}$ -in.

Lower switch and wires down through master clutch lever slot; hold in position with holes back of slot, and install bolts. Clutch lever should be pulled back, engaging clutch, when installing switch. End of switch lever should point toward center of tractor.

96. WIRING.

a. The schematic diagram of the wiring of the tractor shown in figure 105 shows the length of the wires and their distinguishing colors. After a tractor has been in use for a length of time, it may be necessary when replacing a wire or wires to strip the loom of a harness of wires back a little way to expose the wires and determine their coloring. The entire system with the exception of electric trailer brakes can be re-wired from this diagram. See Figure 111 for schematic wiring diagram of electric trailer brake system.

ELECTRICAL SYSTEM AND EQUIPMENT

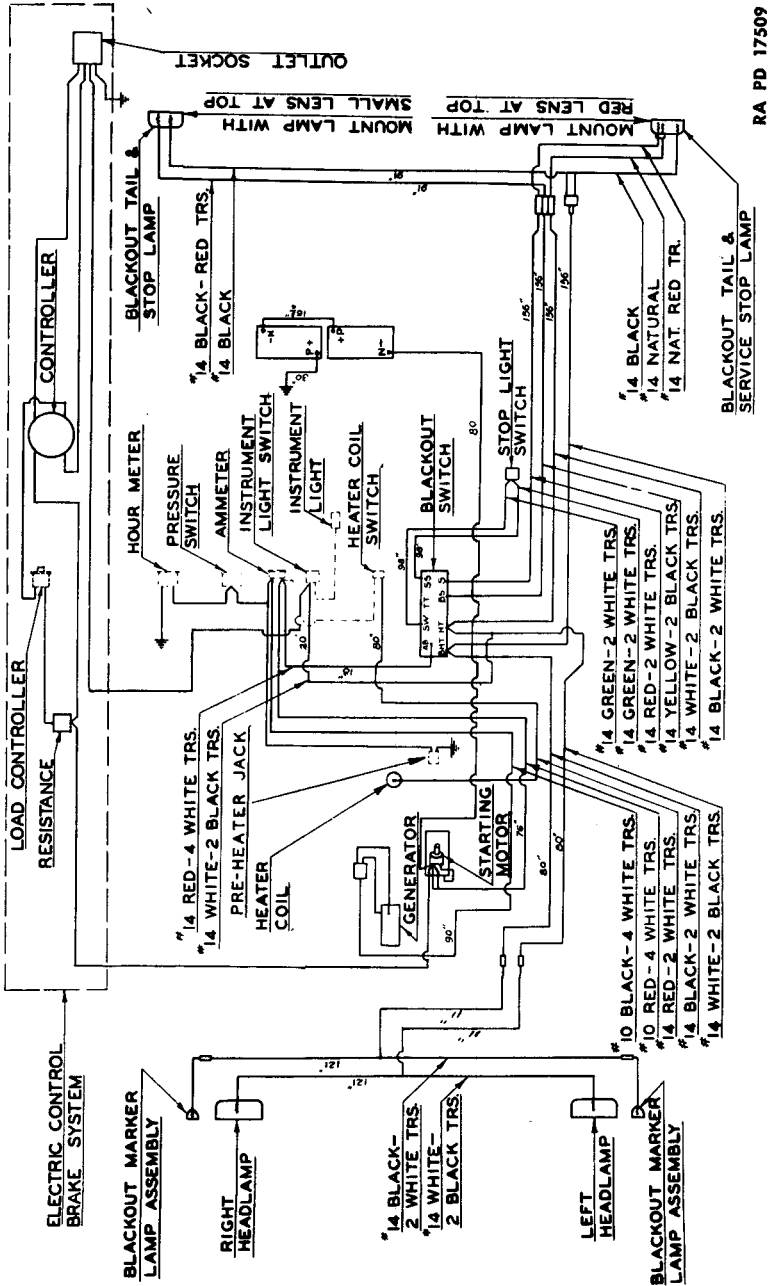

RA PD 17509

Figure 105—Schematic Wiring Diagram

HEAVY TRACTOR M1

b. Replacement of wires is seldom necessary unless the wires are destroyed by fire or like causes. A broken wire can be repaired easily by stripping about an inch of insulation off the two broken ends, twisting the two ends together and wrapping the spliced section with adhesive or friction tape. Any portions of the wire that have the insulation rubbed off through rubbing on some part of tractor should be wrapped with tape to prevent short circuits.

c. There are no fuses in the wiring system of the tractor. A thermal cut-out unit on the main light switch automatically shuts off current from circuit in which a short circuit occurs. After the short circuit is located, the wire shorted may be pulled from the closest connector between it and switch and only that part of the electrical system will be inoperative. Operation can continue then if time or facilities for repair are lacking. However, the cause of shorting should be remedied as soon as possible so entire system will be in operating condition.

Section XVI

NONELECTRICAL INSTRUMENTS

| | Paragraph |
|---|-----------|
| Lubricating oil pressure gage | 97 |
| Fuel pressure gage | 98 |
| Temperature gage | 99 |
| Air pressure gage | 100 |
| Mile meter | 101 |

97. LUBRICATING OIL PRESSURE GAGE (fig. 10).

a. Description. The lubricating oil pressure gage is located in the instrument panel. A dial facing the operator registers the pressure of the lubricating oil delivered to the engine. At engine operating speed and temperature, the oil pressure should be between 25 and 35 pounds. If pressure falls below 25 pounds (at full throttle), the cause should be immediately determined.

b. Removal.

PLIERS
SCREWDRIVER

WRENCH, open-end, $\frac{9}{16}$ -in.

(1) REMOVE INSTRUMENT PANEL.
SCREWDRIVER

Remove the four cross-recessed screws holding panel to dash and pull panel back carefully until fittings at rear of oil pressure gage can be reached.

(2) REMOVE GAGE.
PLIERS
SCREWDRIVER

WRENCH, open-end, $\frac{9}{16}$ -in.

Remove the three cross-recessed screws holding gage in panel. Hold pipe elbow with pliers and unscrew lubricating oil pressure gage from elbow with $\frac{9}{16}$ -inch open-end wrench.

c. Installation.

PERMATEX or WHITE
LEAD
PLIERS

SCREWDRIVER
WRENCH, open-end, $\frac{9}{16}$ -in.

(1) INSTALL GAGE IN PIPE ELBOW.
PERMATEX or WHITE
LEAD
PLIERS

WRENCH, open-end, $\frac{9}{16}$ -in.

HEAVY TRACTOR M1

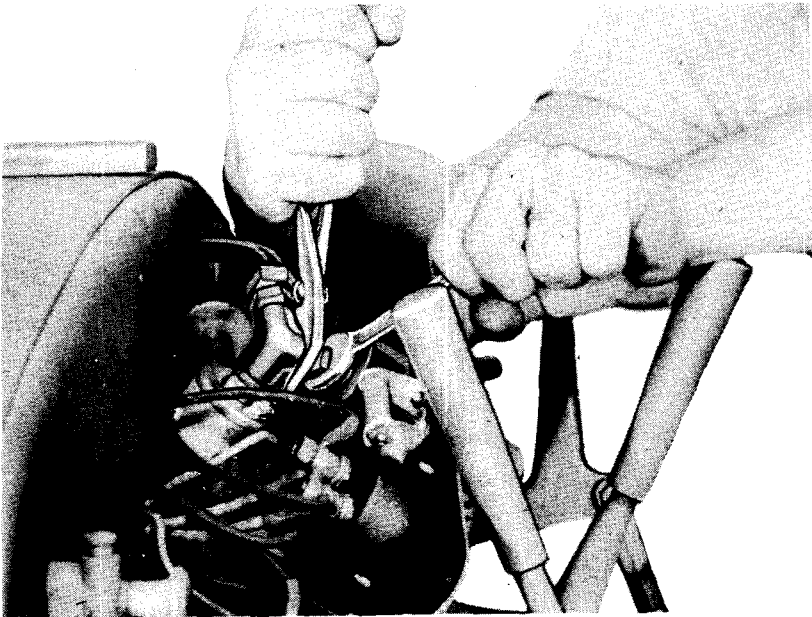

RA PD 17603

Figure 106—Removing Lubricating Oil Pressure Gage

Coat threads of gage with permatex or white lead and screw into pipe elbow. Tighten, using pliers to hold elbow; the wrench to turn gage. Turn so that the gage dial is in correct position and the hour meter pressure switch stands up.

(2) INSTALL GAGE IN PANEL.

SCREWDRIVER

Secure gage to panel with the three cross-recessed screws.

(3) INSTALL PANEL IN DASH.

SCREWDRIVER

Work panel back into dash and secure with the four cross-recessed screws. Start engine and check operation of lubricating oil pressure gage.

98. FUEL PRESSURE GAGE.

a. **Description** (fig. 106). The fuel pressure gage is similar to the lubricating oil pressure gage. The dial registers the fuel pressure to the injectors. A fuel line from a point between the third stage fuel filter and the intake manifold leads to the gage.

b. Normal fuel pressure is from 20 to 30 pounds and may be even higher than 30 pounds. In the event that high fuel pressure is

NONELECTRICAL INSTRUMENTS

experienced, remove fuel tank filler cap and, with engine running at full throttle, observe if a full stream of fuel is returning into tank. If not, there may be clogged filters in the system or injectors, or the restricted fitting at rear end of return fuel manifold may be clogged. If there is a good stream of fuel returning into tank, no correction is necessary and the high fuel pressure will cause no damage (sec. XII).

c. Removal.

- | | |
|---|--|
| SCREWDRIVER | WRENCH , open-end, $\frac{5}{8}$ -in. |
| WRENCH , open-end, $\frac{9}{16}$ -in. | WRENCH , open-end, $\frac{7}{8}$ -in. |

(1) REMOVE INSTRUMENT PANEL FROM DASH.

SCREWDRIVER

Remove the four cross-recessed screws holding panel to dash and pull panel out of dash far enough to reach fuel lines with wrenches.

(2) DISCONNECT FUEL LINE.

- | | |
|--|--|
| WRENCH , open-end, $\frac{3}{8}$ -in. | WRENCH , open-end, $\frac{7}{8}$ -in. |
|--|--|

Disconnect fuel line, holding coupling with $\frac{3}{8}$ -inch open-end wrench, and turn nut off with $\frac{7}{8}$ -inch, open-end wrench.

(3) REMOVE RESTRICTION UNIT.

- WRENCH**, open-end, $\frac{9}{16}$ -in.

Unscrew restriction unit out of elbow.

(4) REMOVE GAGE.

SCREWDRIVER

Remove the three cross-recessed screws holding gage in panel and remove gage. Remove elbow from gage.

d. Installation.

- | | |
|---|--|
| PERMATEX | WRENCH , open-end, $\frac{5}{8}$ -in. |
| SCREWDRIVER | WRENCH , open-end, $\frac{7}{8}$ -in. |
| WRENCH , open-end, $\frac{9}{16}$ -in. | |

(1) INSTALL ELBOW ON GAGE.

- | | |
|---------------------------------|---------------|
| PERMATEX or WHITE | PLIERS |
| LEAD | |

Coat threads of elbow with permatex or white lead and screw elbow into gage.

(2) INSTALL GAGE IN INSTRUMENT PANEL.

SCREWDRIVER

Set gage in place in panel and secure with three cross-recessed screws.

(3) INSTALL RESTRICTION UNIT.

- | | |
|---------------------------------|---|
| PERMATEX or WHITE | WRENCH , open-end, $\frac{9}{16}$ -in. |
|---------------------------------|---|

LEAD

Coat threads of unit with permatex or white lead and screw into elbow. Restriction unit and elbow should point towards the right.

HEAVY TRACTOR M1

(4) CONNECT FUEL LINE.

WRENCH, open-end, $\frac{5}{8}$ -in. **WRENCH**, open-end, $\frac{7}{8}$ -in.

Screw connector into restriction unit and then connect fuel line with nut on end of line.

(5) INSTALL PANEL IN DASH.

SCREWDRIVER

Work wires and lines back through panel opening and install screws in panel and dash.

99. TEMPERATURE GAGE.

a. Description. The temperature gage assembly consists of a thermo gage tube, cable, and dial gage. The dial registers the temperature of the water in the engine. It is actuated by the tube which is mounted in the rear of the water manifold.

b. Removal.

SCREWDRIVER

WRENCH, open-end, $1\frac{1}{16}$ -in.

WRENCH, open-end, $\frac{9}{16}$ -in.

(1) **DRAIN COOLING SYSTEM.** Open drain cock in lower connector elbow and drain out enough water to bring level below water manifold.

(2) **REMOVE CLIP AND CAP SCREW.**

WRENCH, open-end, $\frac{9}{16}$ -in.

Remove cap screw from balance weight housing holding clip and pipe.

(3) **REMOVE THERMO GAGE TUBE.**

WRENCH, open-end, $1\frac{1}{16}$ -in.

Remove thermo gage tube from rear of water manifold.

(4) **REMOVE TEMPERATURE GAGE ASSEMBLY.**

SCREWDRIVER

Remove three cross-recessed screws holding gage in panel, and remove gage, cable, thermo gage tube through cowl and dash, as an assembly.

c. Installation.

SCREWDRIVER

WRENCH, open-end, $1\frac{1}{16}$ -in.

WRENCH, open-end, $\frac{9}{16}$ -in.

(1) **INSTALL GAGE IN PANEL.**

SCREWDRIVER

Insert end of cable through temperature gage hole in dash panel, then through hole in cowl. Place gage in panel and install the three cross-recessed screws.

NONELECTRICAL INSTRUMENTS

(2) **INSTALL THERMO GAGE TUBE IN WATER MANIFOLD.**

WRENCH, open-end, $\frac{1}{16}$ -in.

Insert tube into hole in rear of water manifold, screw in and tighten retaining nut.

(3) **INSTALL CLIP AND CAP SCREW.**

WRENCH, open-end, $\frac{9}{16}$ -in.

Place clip around cable; cap screw through clip and into side hole in balance weight cover, and tighten.

(4) **ADD WATER TO COOLING SYSTEM.**

100. AIR PRESSURE GAGE (fig. 10).

a. **General.** The air pressure gage registers pressure of air in trailer air brake control system. It is important to watch gage to see that air pressure rises after engine is started to be sure the trailer air brake system is in operating order.

b. **Removal.**

WRENCH, open-end, $\frac{1}{2}$ -in.

WRENCH, open-end, $\frac{5}{8}$ -in.

WRENCH, open-end, $\frac{9}{16}$ -in.

(1) **DISCONNECT AIR LINE TO GAGE.**

WRENCH, open-end, $\frac{9}{16}$ -in.

WRENCH, open-end, $\frac{5}{8}$ -in.

Open petcock on bottom of air reservoir to relieve pressure. To disconnect air line at gage, hold coupling from turning with smaller wrench and turn nut off with larger wrench.

(2) **REMOVE RETAINING NUTS.**

WRENCH, open-end, $\frac{1}{2}$ -in.

Remove nuts from bolts through bracket at rear of gage and remove air pressure gage from dash.

c. **Installation.**

WRENCH, open-end, $\frac{1}{2}$ -in.

WRENCH, open-end, $\frac{5}{8}$ -in.

WRENCH, open-end, $\frac{9}{16}$ -in.

(1) **INSTALL GAGE IN DASH.**

WRENCH, open-end, $\frac{1}{2}$ -in.

Place gage in hole in dash with bolts on gage through bracket back of dash. Install nuts and tighten to hold gage firmly.

(2) **CONNECT AIR LINE.**

WRENCH, open-end, $\frac{9}{16}$ -in.

WRENCH, open-end, $\frac{5}{8}$ -in.

Start nut on coupling, hold coupling with smaller wrench and tighten with larger wrench. Close petcock on air reservoir.

101. MILE METER (fig. 10).

a. **General.** The mile meter is driven by a flexible shaft inside a

HEAVY TRACTOR M1

housing extending from the back of meter into the transmission case to a gear on the front end of the lower transmission shaft.

b. If the mile meter becomes inoperative, make the following check:

(1) With pliers, disconnect the cable from the bottom of the meter by unscrewing the retainer nut which holds the shaft housing to the meter.

(2) Put the tractor in motion and observe whether the shaft turns inside its retainer. If it does, the mile meter should be replaced. If it does not, the shaft is broken or the gears at the lower end of shaft are stripped. In this case, the drive assembly will have to be replaced. Replacement of meter can be done by the using arm, but not replacement of the drive assembly.

c. Removal of Meter.

PLIERS

SCREWDRIVER

(1) DISCONNECT CABLE.

PLIERS

Loosen retainer nut, which holds end of housing to bottom of meter, with pliers and unscrew it from meter. Pull cable and housing from meter.

(2) REMOVE METER FROM DASH.

SCREWDRIVER

Remove the three cross-recessed screws which hold meter to dash and pull mile meter from dash.

d. Installation.

PLIERS

SCREWDRIVER

(1) INSTALL METER IN DASH.

SCREWDRIVER

Place meter in hole in dash and install three cross-recessed screws through flange of meter and into dash.

(2) CONNECT DRIVE CABLE AND HOUSING.

PLIERS

The end of drive cable is square and fits into a square socket in meter drive. Insert the cable in meter, hold up on cable housing and screw retainer nut on meter. Tighten lightly with pliers.

Section XVII

ELECTRIC AND AIR TRAILER BRAKE CONTROL SYSTEM

| | Paragraph |
|-----------------------|-----------|
| Description | 102 |
| Air brakes | 103 |
| Electric brakes | 104 |

102. DESCRIPTION.

a. The trailer brake control system on the tractor is designed to operate the brakes on vehicles to be pulled, and which might be equipped with either air or electric brakes. The control on the right steering clutch lever operates both the air brake valve and the electric brake controller; however, only one of the brake systems operates at one time (fig. 10).

b. In addition to the steering clutch lever control, an auxiliary hand operated air valve control mounted on the tractor dash may be used to apply the trailer air brakes. A rheostat mounted on the tractor dash is provided to regulate the intensity of brake application to meet varying brake requirements when the electric brakes are to be used.

103. AIR BRAKES.

a. **Air Compressor.** The compressor is a two-cylinder, Bendix-Westinghouse Model No. 2—US—7¼—VW. It is mounted on a bracket which is bolted to the cylinder block. The compressor is water-cooled; has its own oil supply system and pumping system; and is driven by belts from a pulley on the engine crankshaft. An air governor regulates the air reservoir pressure and when this reaches 105 pounds per square inch, the governor opens an unloader valve. This permits the air displaced by the upward movement of the piston to pass from one cylinder to the other without compression.

b. Maintenance of Air Compressor.

(1) The air compressor lubricating oil should be drained and refilled each time the oil in engine crankcase is changed. Use an engine oil of the same viscosity as is used in engine.

(2) Remove the air filter (fig. 107) by removing two cap screws holding it to compressor (use a 7/16-inch open-end wrench), and wash mat with SOLVENT, dry-cleaning, or fuel oil, after every 100 hours of operation, or oftener if operating under extremely dusty conditions. Saturate the filter mat with OIL, lubricating, engine, SAE 10, before reinstalling.

(3) Oil the unloader rocker arm fulcrum pin with OIL, lubricating, engine, SAE 10, after every 100 hours of operation.

ELECTRIC AND AIR TRAILER BRAKE CONTROL SYSTEM

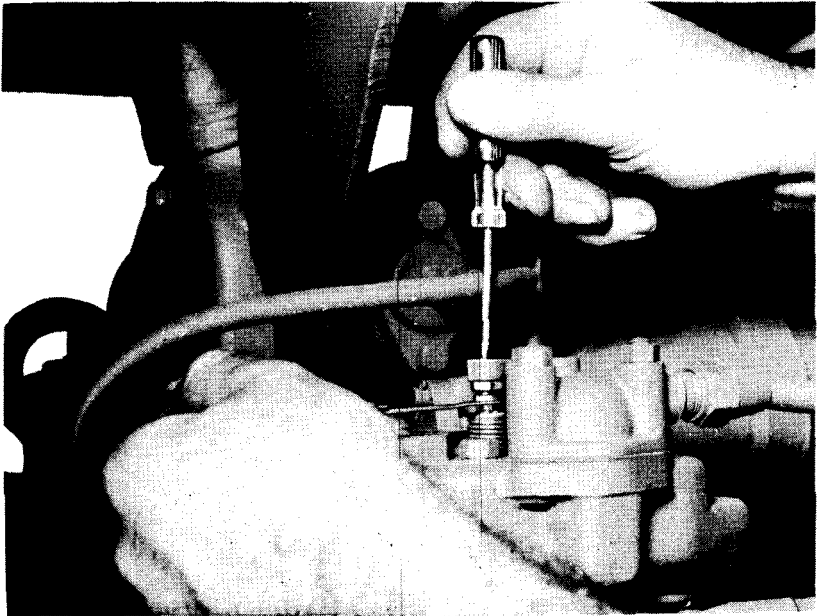

RA PD 17262

Figure 108—Adjusting Compressor Valve Clearance

(6) The compressor drive belt should be adjusted periodically.

c. Removal of Air Compressor.

WRENCH, open-end, $\frac{5}{8}$ -in.

WRENCH, open-end, $\frac{7}{8}$ -in.

WRENCH, open-end, $2\frac{5}{32}$ -in.

(1) **DISCONNECT AIR LINES.**

WRENCH, open-end, $\frac{5}{8}$ -in.

WRENCH, open-end, $\frac{7}{8}$ -in.

Disconnect air lines from compressor and remove the cap screw holding the air line tubing clips to air compressor support bracket.

(2) **DISCONNECT WATER LINES.**

WRENCH, open-end, $\frac{5}{8}$ -in.

Disconnect inlet and outlet water lines from air compressor.

(3) **REMOVE AIR COMPRESSOR.**

WRENCH, open-end, $\frac{5}{8}$ -in.

WRENCH, open-end, $2\frac{5}{32}$ -in.

Remove two cap screws and two bolts holding air compressor unit to support bracket, slip belts from pulley, and lift off air compressor.

d. Installation of Air Compressor.

WRENCH, open-end, $\frac{5}{8}$ -in.

WRENCH, open-end, $\frac{7}{8}$ -in.

WRENCH, open-end, $2\frac{5}{32}$ -in.

HEAVY TRACTOR M1

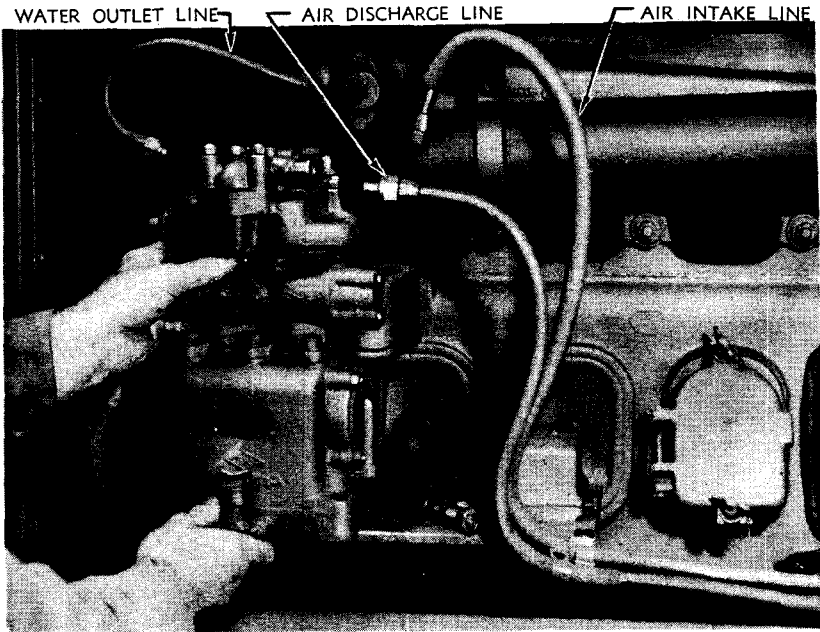

RA PD 56391

Figure 109—Removing Air Compressor

(1) INSTALL UNIT TO SUPPORT BRACKET.

WRENCH, open-end, 5/8-in. **WRENCH**, open-end, 2 5/8-in.

Set air compressor on support bracket, slip generator belt and drive belt on pulley and install two bolts and two cap screws.

(2) CONNECT WATER LINES.

WRENCH, open-end, 5/8-in.

Connect the two water lines to head of air compressor.

(3) CONNECT AIR LINES.

WRENCH, open-end, 5/8-in. **WRENCH**, open-end, 7/8-in.

Connect the two air lines to compressor.

(4) ADJUST AIR COMPRESSOR AND GENERATOR DRIVE BELTS. Adjust air compressor drive belt first, following instructions below. Refer to paragraph 87 for generator drive belt adjustment.

e. Air Compressor Drive Belt Adjustment.

SCREWDRIVER

WRENCH, socket, 9/16-in., with extension

WRENCH, open-end, 1/2-in.

WRENCH, open-end, 5/8-in.

WRENCH, socket, 5/8-in.

WRENCH, open-end, 3/4-in.

WRENCH, socket, 3/4-in.

(1) REMOVE LEFT FRONT FENDER AND GENERATOR. Refer to paragraph 87.

ELECTRIC AND AIR TRAILER BRAKE CONTROL SYSTEM**(2) ADJUST COMPRESSOR BELT.**

WRENCH, socket, $\frac{5}{8}$ -in.

Loosen cap screws holding compressor bracket to engine. Slide bracket up or down to tighten or loosen belt. Adjust so one side of belt at point halfway between pulleys can be pushed inward, towards other side, about one inch.

(3) TIGHTEN CAP SCREWS HOLDING BRACKET.

WRENCH, socket, $\frac{5}{8}$ -in.

Tighten cap screws holding compressor bracket to engine. Make sure compressor and bracket are square with engine so belt pulley will be in line.

(4) INSTALL GENERATOR AND FENDER. Refer to paragraph 87 for installation of generator and fender and generator belt adjustment.

f. Removal of Dash-Mounted Air Valve.

WRENCH, open-end, $\frac{9}{16}$ -in. WRENCH, socket, $\frac{9}{16}$ -in.

WRENCH, open-end, $\frac{5}{8}$ -in.

(1) DISCONNECT AIR LINES.

WRENCH, open-end, $\frac{5}{8}$ -in.

Disconnect the three air lines from valve.

(2) REMOVE VALVE.

WRENCH, open-end, $\frac{9}{16}$ -in. WRENCH, socket, $\frac{9}{16}$ -in.

Remove the two bolts holding valve to dash and lift out valve.

g. Installation of Dash-Mounted Air Valve.

WRENCH, open-end, $\frac{9}{16}$ -in. WRENCH, socket, $\frac{9}{16}$ -in.

WRENCH, open-end, $\frac{5}{8}$ -in.

(1) INSTALL VALVE ON DASH.

WRENCH, open-end, $\frac{9}{16}$ -in. WRENCH, socket, $\frac{9}{16}$ -in.

Hold valve in position against dash and install the two bolts.

(2) CONNECT AIR LINES TO VALVE.

WRENCH, open-end, $\frac{5}{8}$ -in.

Connect the three air lines to valve. Start engine and check operation of valve.

h. Removal of Steering Lever Controlled Air Control Valve.

PLIERS WRENCH, open-end, $\frac{5}{8}$ -in.

WRENCH, open-end, $\frac{1}{2}$ -in.

(1) DISCONNECT AIR LINES.

WRENCH, open-end, $\frac{5}{8}$ -in.

Remove floor plate (par. 104 c (2)). Disconnect the air lines at valve.

HEAVY TRACTOR M1

(2) DISCONNECT CONTROL LINK.

PLIERS

Remove cotter pin from pin in yoke and remove yoke pin from air valve actuating lever.

(3) REMOVE VALVE.

WRENCH, open-end, $\frac{1}{2}$ -in.

Remove four cap screws holding valve to bracket on battery support and lift valve.

i. Installation of Steering Lever Controlled Air Control Valve.

WRENCH, open-end, $\frac{1}{2}$ -in.

WRENCH, open-end, $\frac{5}{8}$ -in.

WRENCH, open-end, $\frac{9}{16}$ -in.

(1) INSTALL VALVE.

WRENCH, open-end, $\frac{1}{2}$ -in.

Hold valve in position against bracket on battery support and install the four cap screws.

(2) CONNECT AIR LINES.

WRENCH, open-end, $\frac{5}{8}$ -in.

Connect the air lines to fittings on valves.

(3) ADJUST AIR VALVE CONTROL ROD.

WRENCH, open-end, $\frac{9}{16}$ -in.

Connect link rod to the air valve actuating lever, installing pin in fourth hole from top of the air valve actuating lever. Loosen jam nut on steering lever control rod and remove pin. Adjust control rod with clevis (shorten or lengthen rod) to obtain full travel of the air brake actuating lever when the steering lever brake control is fully depressed. **NOTE:** After the air valve adjustment has been made, adjust the electric brake control rod for full travel of the electric brake control lever. This is done by means of the adjustable yoke on the control rod and should be done to obtain full travel of actuating controller lever when control grip on steering lever is fully depressed. Install cotter pins in yoke pins, and install floor plate (par. 104 d (5)).

j. Air Lines. All air lines should be inspected periodically to detect cracked or broken lines or loose connections. Replace broken or missing tubing clips holding air lines to tractor frame. This is important as these clips prevent lines from vibrating and breakage which may result.

104. ELECTRIC BRAKES.

a. Controller. The controller is mounted on the inside of the right rear fender of tractor and is operated by linkage from the steering lever grip control (fig. 110).

b. Load Control Unit. The load control unit, mounted on the dash, is a rheostat for regulating the amount of current supplied to the

ELECTRIC AND AIR TRAILER BRAKE CONTROL SYSTEM

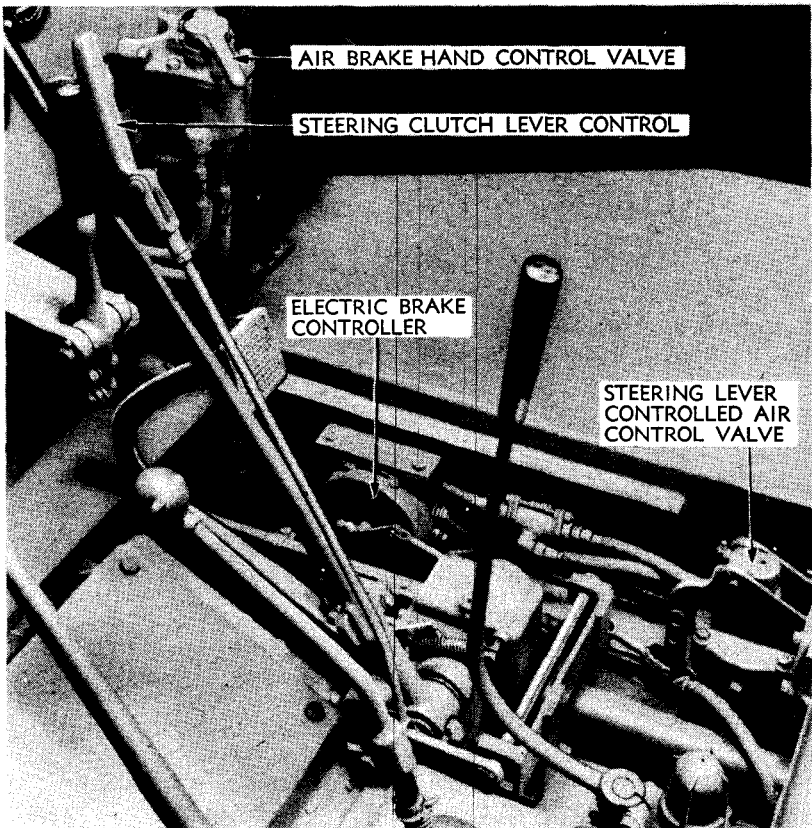

RAPD 18021

Figure 110—Electric Brake Controller and Air Brake Control Valves

controller. Application of brakes on a light vehicle requires less current than on those of a heavy vehicle. Turning knob to left decreases and to the right increases the braking effect.

c. Removal of Controller.

PLIERS

TAPE, friction

WRENCH, open-end, $\frac{3}{8}$ -in.

WRENCH, open-end, $\frac{9}{16}$ -in.

WRENCH, open-end, $\frac{3}{4}$ -in.

WRENCH, socket, $\frac{9}{16}$ -in.

(1) REMOVE ROD FROM POWER TAKE-OFF SHIFTER LEVER.

PLIERS

Remove pin from power take-off shifter lever.

(2) REMOVE FLOOR PLATE.

WRENCH, open-end, $\frac{3}{4}$ -in.

WRENCH, open-end, $\frac{9}{16}$ -in.

WRENCH, socket, $\frac{9}{16}$ -in.

HEAVY TRACTOR M1

Remove two cap screws holding clutch lever stop to top of floor plate and transmission cover and remove stop. Remove plate over top of master clutch inspection cover by removing two cap screws. Remove two bolts and eight cap screws and remove floor plate. Loosen three bolts on outside of each fender which hold foot braces. Hold rear of floor plate higher than front while removing.

(3) DISCONNECT CONTROL LINK.

PLIERS

Remove cotter pin and pin in yoke to disconnect link from lever on controller.

(4) REMOVE WIRES FROM CONTROLLER.

WRENCH, open-end, $\frac{3}{8}$ -in.

Remove four nuts which hold wires on controller. Tag each wire to identify it with post from which it was removed. Tape ends of both wires on front of controller as they are taken off.

(5) REMOVE CONTROLLER.

WRENCH, open-end, $\frac{9}{16}$ -in.

WRENCH, socket, $\frac{9}{16}$ -in.

Remove two bolts holding controller to controller bracket and lift controller out of tractor.

d. Installation of Controller.

PLIERS

WRENCH, open-end, $\frac{3}{4}$ -in.

WRENCH, open-end, $\frac{3}{8}$ -in.

WRENCH, socket, $\frac{9}{16}$ -in.

WRENCH, open-end, $\frac{9}{16}$ -in.

(1) INSTALL CONTROLLER.

WRENCH, open-end, $\frac{9}{16}$ -in.

WRENCH, socket, $\frac{9}{16}$ -in.

Install controller with two bolts through bracket on fender.

(2) INSTALL WIRES ON CONTROLLER.

WRENCH, open-end, $\frac{3}{8}$ -in.

Place wires on proper posts of controller. If wires are not marked, refer to schematic drawing of electric brake wiring diagram (fig. 111).

(3) CONNECT CONTROL ROD.

PLIERS

Connect control rod to lever on controller with pin. Adjust rod by means of adjustable yoke to obtain full travel of actuating controller lever when control grip on steering lever is fully depressed. Install cotter pin in yoke pin.

(4) INSTALL ROD ON POWER TAKE-OFF SHIFTER LEVER.

PLIERS

Install pin in power take-off shifter lever.

(5) INSTALL FLOOR PLATE.

WRENCH, open-end, $\frac{9}{16}$ -in.

WRENCH, socket, $\frac{9}{16}$ -in.

WRENCH, open-end, $\frac{3}{4}$ -in.

ELECTRIC AND AIR TRAILER BRAKE CONTROL SYSTEM

Lower floor plate with steering levers through hole in plate. Slip front end under bracket of foot brace. Install bolts and cap screws in floor plate and tighten bolts on outside of fenders which hold foot braces. Install plate over master clutch inspection cover. Install steering clutch lever stop.

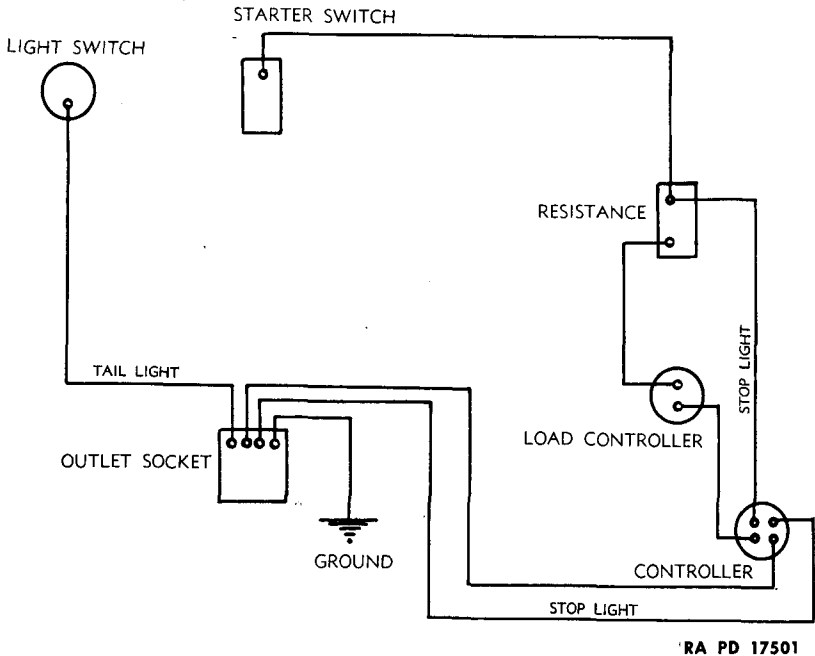

Figure 111—Wiring Diagram—Electric Brake Control System

e. Removal of Load Control Unit.

SCREWDRIVER

TAPE, friction

WRENCH, open-end, 5/8-in.

WRENCH, open-end, 7/16-in.

(1) REMOVE KNOB.

SCREWDRIVER

Loosen small set screw in side of knob and slip knob from shaft.

(2) REMOVE LOAD CONTROL UNIT FROM DASH.

WRENCH, open-end, 5/8-in.

Remove jam nut from unit and pull load control unit from dash. Notice position of insulating washers.

(3) DISCONNECT WIRES.

WRENCH, open-end, 7/16-in.

Remove two nuts holding wires to unit. Tape end of each wire as it is removed.

HEAVY TRACTOR M1

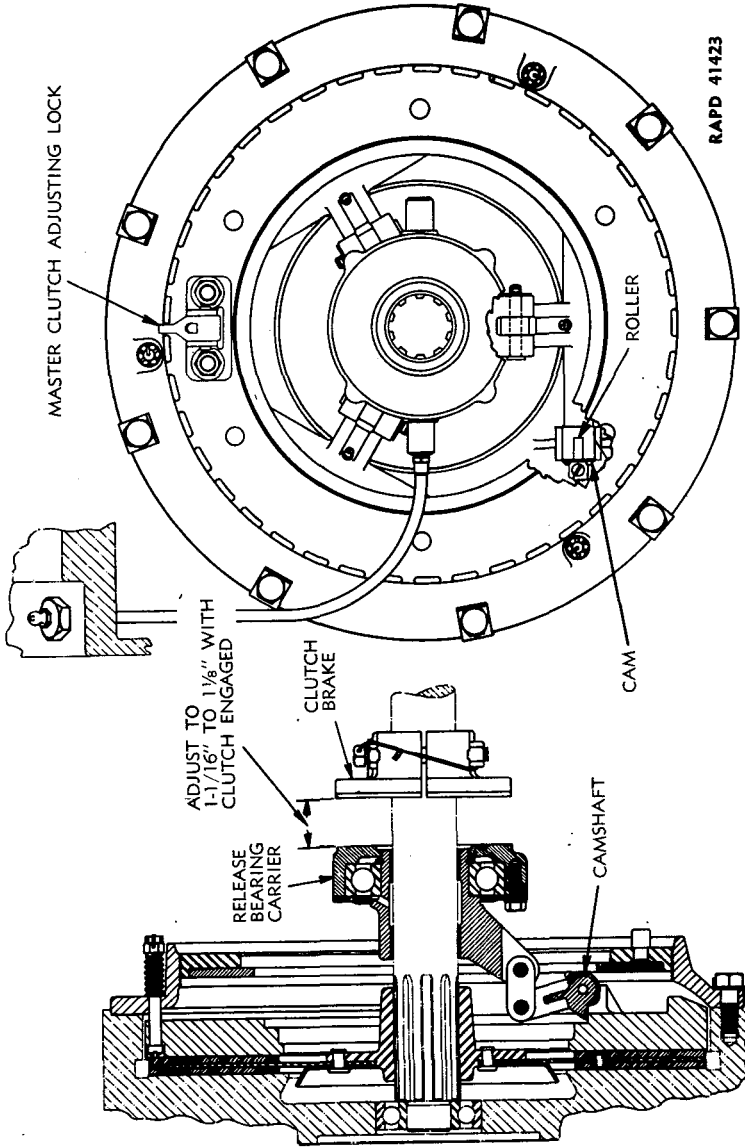

Figure 112—Cross Section of Master Clutch

ELECTRIC AND AIR TRAILER BRAKE CONTROL SYSTEM

f. Installation of Load Control Unit.

SCREWDRIVER

WRENCH, open-end, $\frac{5}{8}$ -in.

WRENCH, open-end, $\frac{7}{16}$ -in.

(1) CONNECT WIRES TO UNIT.

WRENCH, open-end, $\frac{7}{16}$ -in.

(2) INSTALL UNIT IN DASH.

WRENCH, open-end, $\frac{5}{8}$ -in.

Insert shaft of unit through dash from back side. Place dial and insulating washer over shaft and screw on jam nut. Before tightening nut, be sure insulating washers are in proper position and dial is placed with numbers at top.

(3) INSTALL KNOB.

SCREWDRIVER

Place knob on shaft and tighten set screw. When correctly installed, arrow on knob will point to "1" on dial when knob is turned all the way to the left (counterclockwise), and will point to "4" when knob is turned all the way to right (clockwise).

MASTER CLUTCH AND CLUTCH BRAKE

| | Paragraph |
|------------------------------------|-----------|
| Description | 105 |
| Operation | 106 |
| Trouble shooting | 107 |
| Clutch adjustment | 108 |
| Master clutch brake assembly | 109 |

105. DESCRIPTION.

a. The master clutch is an over-center cam engaging type. A screw thread adjustment between the adjusting ring and back plate provides the necessary adjustment to assure proper clutch operation. A driven disk, with friction lining on both sides, is riveted to a splined hub carried on the master clutch shaft. All other parts of the clutch except the release mechanism and clutch brake are bolted to the engine flywheel.

106. OPERATION.

a. To engage the clutch, the pressure plate is forced forward against the driven disk by means of the control lever and linkage. This tightly clamps the clutch driven disk between the pressure plate and flywheel, thus transferring power from flywheel to the driven disk, which carries it to the transmission. As the control lever is pulled all the way back, the over-center cams snap in to hold the clutch engaged until pressure on the control lever snaps them out to release the clutch. A flexible grease tube extends from outside the clutch housing to the release bearing for lubrication of the bearing. The shafts on which the three cams are mounted have rollers on each end, making operation easier. These shafts are equipped with pressure gun fittings for lubrication purposes.

107. TROUBLE SHOOTING.

a. Slipping.

| Probable Cause | Probable Remedy |
|-------------------------|---|
| Improper adjustment. | Adjust clutch. |
| Oily facings. | Wash out clutch. Inspect rear main bearing seal and wick in crankshaft for excess oil loss. |
| Worn or glazed facings. | Notify ordnance personnel. |
| Warped pressure plate. | Notify ordnance personnel. |

MASTER CLUTCH AND CLUTCH BRAKE

b. Does Not Engage.

| Probable Cause | Probable Remedy |
|------------------------------|--|
| Facing torn off. | Notify ordnance personnel. |
| Release bearing failure. | Notify ordnance personnel. |
| Adjusting lock worked loose. | Adjust clutch and inspect locking lug. |

c. Hard to Operate.

| | |
|---|---|
| Clutch cams dry. | Lubricate pressure grease fittings on cam assemblies. |
| Warped pressure plate. | Notify ordnance personnel. |
| Throw-out bearing or clutch sleeve dry. | Lubricate the bearing which also lubricates the sleeve and shaft. |
| Linkage worn. | Install new parts and lubricate with engine oil. |
| Linkage binding. | Clean and lubricate. |
| Lining torn off. | Notify ordnance personnel. |

d. Clutch Disengages When in Operation.

| | |
|--|----------------------------|
| Pressure plate worn in cam guides. | Notify ordnance personnel. |
| Cam blocks worn. | Notify ordnance personnel. |
| Cam shaft rollers and assemblies worn. | Notify ordnance personnel. |

e. Noise, Rattles or Squeaks.

| | |
|----------------------------|----------------------------|
| Pilot bearing failure. | Notify ordnance personnel. |
| Release bearing failure. | Notify ordnance personnel. |
| Worn clutch shaft splines. | Notify ordnance personnel. |

f. Clutch Will Not Disengage.

| | |
|---|----------------------------|
| Pilot bearing failure (bearing "seized"). | Notify ordnance personnel. |
|---|----------------------------|

108. CLUTCH ADJUSTMENT.

a. Engagement of the master clutch when in proper adjustment requires a pull of from 50 to 55 pounds on the control lever when engine is idling, or from 60 to 65 pounds when engine is stopped. It should engage with a snap and lever will lock into position with an over-center action. When this action is not present or when the pull required on the lever to engage clutch drops to around 30 pounds, it indicates that the clutch should be adjusted before slippage occurs. These figures assume that there is no binding in any of the linkage. If the linkage is binding in any place, those parts or joints should be freed and lubricated before attempting to obtain the correct adjustment. Do not adjust the clutch

HEAVY TRACTOR M1

too tightly, as that would result in faster wear on the linkage and make operation harder. Proceed as follows:

BAR, pry, small

WRENCH, socket, $\frac{3}{4}$ -in.

WRENCH, socket, $\frac{9}{16}$ -in.

(1) REMOVE CLUTCH INSPECTION COVER.

WRENCH, socket, $\frac{9}{16}$ -in.

WRENCH, socket, $\frac{3}{4}$ -in.

Remove section of floor plate over inspection cover by removing two cap screws. Remove clutch inspection cover by removing four cap screws.



RA PD 17641

Figure 113—Removing Floor Plate Section

(2) TURN CLUTCH TO ADJUSTING POSITION. Disengage clutch and revolve the clutch until the adjusting lock is located near the inspection hole.

(3) DISENGAGE ADJUSTING LOCK. Hinge adjusting lock back out of slot in back plate.

(4) TURN ADJUSTING RING.

BAR, pry, small

Pry studs on adjusting ring to turn ring. To tighten clutch, turn adjusting ring clockwise; to loosen it, turn the ring counterclockwise. Turn ring in desired direction, a notch at a time, and test pull required on lever to engage clutch until desired pull is obtained.

MASTER CLUTCH AND CLUTCH BRAKE

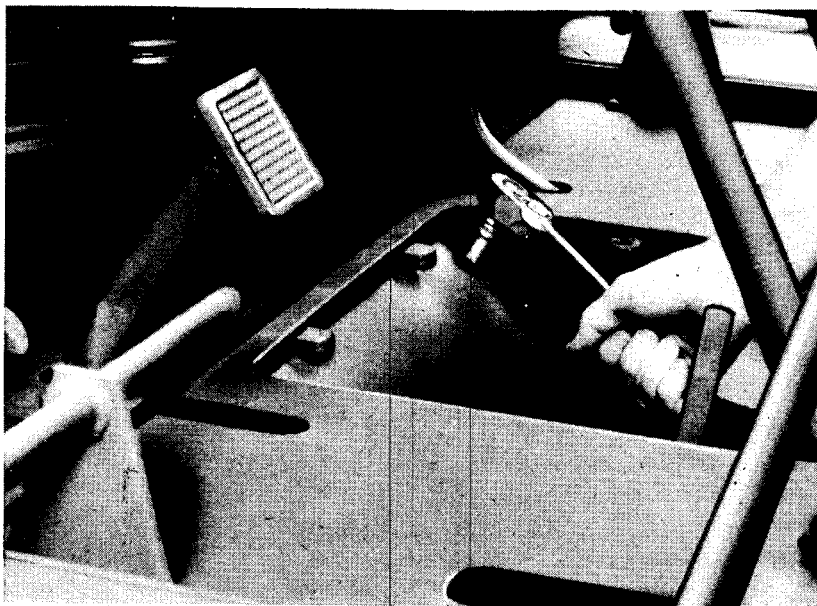

RA PD 17638

Figure 114—Removing Clutch Inspection Cover

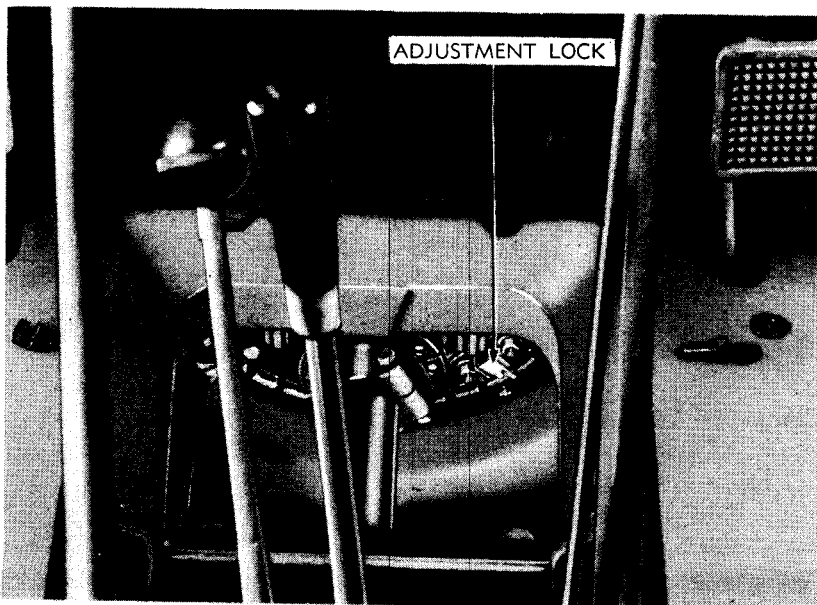

RA PD 17228

Figure 115—Master Clutch Adjusting Lock
201

HEAVY TRACTOR M1

(5) **LOCK RING IN PLACE.** Engage adjusting lock in notch in back plate and install inspection cover and section of floor plate.

b. Washing Master Clutch. If master clutch slips due to over-lubrication of release bearing or oil leaking from engine or transmission into clutch compartment, washing of the clutch and compartment will be necessary. Proceed as follows:

(1) Place ½-inch pipe plug in drain hole at left rear of clutch housing.

(2) Remove inspection hole cover and pour about three gallons of fuel oil or SOLVENT, dry-cleaning, into clutch compartment.

(3) With gear shift lever in neutral position and clutch engaged, start engine. Run engine for five minutes without disengaging clutch; then drain dirty fuel oil or SOLVENT, dry-cleaning, out by removing pipe plug.

(4) Again place pipe plug in drain hole. Pour about three gallons of fuel oil or SOLVENT, dry-cleaning, into clutch compartment and operate engine as before. Disengage and engage master clutch several times while engine is running; then stop engine and drain fuel oil or SOLVENT, dry-cleaning, from compartment.

(5) Lubricate throw-out bearing thoroughly.

(6) Lubricate clutch mechanism and linkage by splashing about a quart of OIL, engine, lubricating, SAE 10, against back of clutch assembly and over release assembly linkage. Allow oil to drain from clutch compartment. **NOTE:** This must be done with clutch engaged. If clutch linkage becomes dry and binds, or is hard to operate, it may be lubricated in this manner.

109. MASTER CLUTCH BRAKE ASSEMBLY.

a. Description. The master clutch brake assembly is a two-piece casting which is bolted around the clutch shaft. The brake is faced on the flanged side with brake lining. When the master clutch lever is pushed forward, the clutch release bearing carrier is forced back against the clutch brake assembly, which stops the transmission gears and permits easy shifting. The throw-out mechanism should contact the brake before operator's hand can come in contact with the dash when pushing lever ahead to disengage clutch and engage clutch brake. The brake does not require adjusting very often but should at least be adjusted before clutch lever can hit dash. This can be done at a time when covers are removed to adjust master clutch.

MASTER CLUTCH AND CLUTCH BRAKE

b. Clutch Brake Adjustment.

PLIERS

WRENCH, open-end, $\frac{9}{16}$ -in.

RULER or SCALE

WRENCH, socket, $\frac{3}{4}$ -in.

(1) REMOVE LOCKING WIRE.

PLIERS

Cut wire running through head of lock screw and around the clutch shaft.

(2) LOOSEN BOLTS.

WRENCH, open-end, $\frac{9}{16}$ -in.

WRENCH, socket, $\frac{3}{4}$ -in.

Loosen lock screw. Loosen bolts that clamp the two halves of clutch brake to clutch shaft.

(3) ENGAGE MASTER CLUTCH.

(4) ADJUST CLEARANCE. Move brake assembly ahead on shaft until space between clutch throw-out assembly and brake measures $1\frac{1}{16}$ -inch to $1\frac{1}{8}$ -inch.

(5) TIGHTEN BOLTS; INSTALL WIRE.

PLIERS

WRENCH, socket, $\frac{3}{4}$ -in.

WRENCH, open-end, $\frac{9}{16}$ -in.

Tighten bolts clamping brake assembly to shaft. Then tighten lock screw and install lock wire through head of lock screw and around shaft.

HEAVY TRACTOR M1

Section XIX

STEERING CLUTCHES

| | Paragraph |
|----------------------------------|-----------|
| Description and operation | 110 |
| Trouble shooting | 111 |
| Steering clutch adjustment | 112 |
| Washing and lubrication | 113 |

110. DESCRIPTION AND OPERATION.

a. The steering clutches are of the multiple disk type with 15 friction disks and 14 steel disks in each clutch assembly. Power is transmitted through these clutches from the bevel gear shaft to the final drive pinion shafts. The steering clutches are released by means of the two levers directly in front of operator (fig. 10). When either clutch is released, the bevel gear shaft turns without driving or supplying power to the final drive pinion shaft on that side.

111. TROUBLE SHOOTING.

a. Steering Clutch Slipping.

| Probable Cause | Probable Remedy |
|--------------------------|----------------------------|
| Improper adjustment. | Adjust clutches. |
| Friction disks worn out. | Notify ordnance personnel. |
| Loss of spring tension. | Notify ordnance personnel. |
| Grease in clutch. | Wash clutches. |

b. Clutch Will Not Disengage.

| | |
|--|----------------------------|
| Improper adjustment. | Adjust clutches. |
| Throw-out bearing failure. | Notify ordnance personnel. |
| Lower end of throw-out fork out of equalizer in bottom of steering clutch compartment. | Notify ordnance personnel. |

112. STEERING CLUTCH ADJUSTMENT.

a. Check each clutch lever for adjustment separately. Perform the following steps to check if steering clutch needs adjustment:

(1) Place one end of a ruler or scale against the dash so it projects horizontally past the top of the steering clutch lever.

(2) Push the lever forward as far as it will go; at this point the bottom end of the lever strikes a stop on the gear shifter housing and prevents it from going too far forward.

STEERING CLUTCHES

(3) Pull the lever back until the lost motion is taken up. This can easily be felt by a definite increase in the pull required to release the clutch.

(4) Observe the measurement of the distance between the dash and the top of the lever when it is in its forward position, and also the distance when the lever is pulled back to the position where the lost motion is all taken up. The free motion or difference between these two measurements should not be less than 3 inches and not more than 5½ inches. As the steering clutches wear, the free motion of the levers becomes less. If the free motion of the lever does not come within the limits of 3 inches to 5½ inches, then proceed with adjustment.

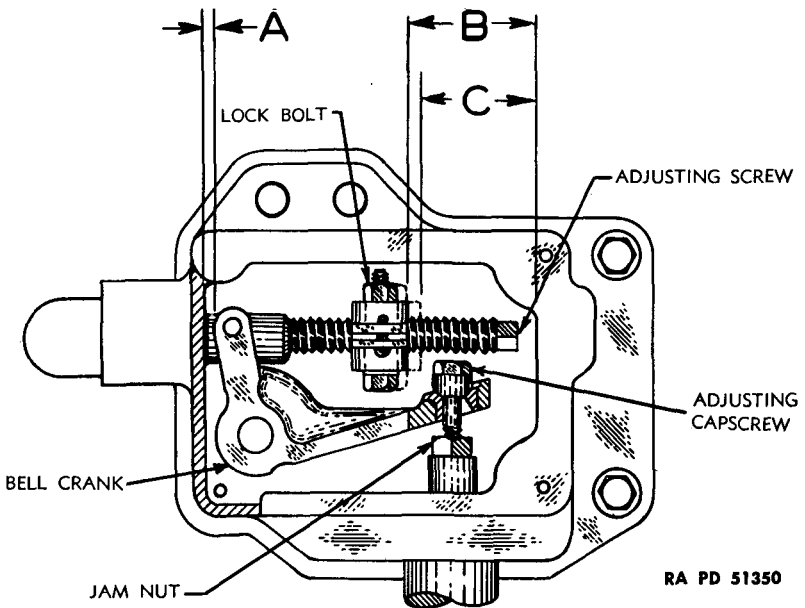

Figure 116—Steering Clutch Adjustments

b. Adjustment.

RULER or SCALE, 12-in.

WRENCH, socket, ¾-in.

WRENCH, open-end, ⅝-in.

WRENCH, socket, ⅞-in., with extension

(2)

WRENCH, open-end, ¾-in.

(2)

(1) REMOVE STEERING CLUTCH VENTILATING COVER.

WRENCH, socket, ¾-in., with extension

WRENCH, socket, ⅞-in.

Remove seat cushions. Remove four cap screws and remove ventilating cover.

HEAVY TRACTOR M1

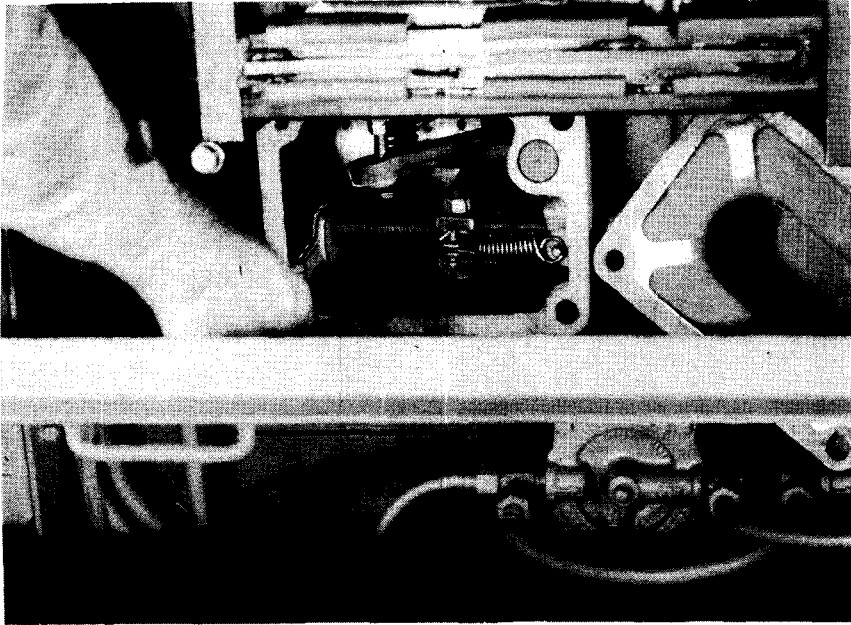

RA PD 17600

Figure 117—Adjusting Steering Clutches

(2) CHECK AND ADJUST CLEARANCE BETWEEN BELL CRANK AND CLUTCH COVER.

SCALE

WRENCH, open-end, $\frac{9}{16}$ -in.
(2)

Check the clearance between the bell crank and steering clutch cover when the steering levers are as far forward as they will go. This clearance (A, fig. 116) should be $\frac{1}{8}$ inch. If this clearance is maintained, there will always be a sufficient amount of clearance between the throw-out bearings and the shifter plate when the top of the steering levers and top of throw-out fork have the proper free motion. If there is not $\frac{1}{8}$ inch clearance, proceed as follows to correct the adjustment: Push the steering clutch levers as far forward as they will go and hold it in that position. Loosen the jam nut and turn the adjusting cap screw in until the end of the bell crank is moved away from the bracket $\frac{1}{8}$ inch. Tighten jam nut. NOTE: This adjustment is very important and it should be done carefully. If there is no clearance at "A," it is possible for the clutch throw-out bearings to ride against the shifter plate even though the steering clutch levers have proper amount of free travel.

STEERING CLUTCHES

- (3) CHECK AND ADJUST FREE TRAVEL OF TOP OF THROW-OUT FORK.
RULER or SCALE, 12-in. WRENCH, open-end, $\frac{3}{4}$ -in.

(2)

Measure distance "B" between top of throw-out fork and edge of cover (steering lever held forward). Then pull steering lever back to end of its free travel or the point where pressure is felt and disengagement of clutch begins. Hold lever in that position and measure distance "C" (between top of throw-out fork and edge of cover). This distance should be $\frac{3}{16}$ inch less than distance "B." This $\frac{3}{16}$ inch free travel of top of throw-out fork can be obtained by loosening nut on lock bolt and turning adjusting screw in or out to decrease or increase the distance "C." When the $\frac{3}{16}$ inch free travel is obtained, tighten nut on lock bolt. The steering clutch lever should now have 5 to 5½ inches free travel at top of lever before disengagement of clutch begins.

113. WASHING AND LUBRICATION.

a. **Washing Clutches.** If grease or oil accumulates in steering clutch compartments from closed drains and leaks or over-lubrication of throw-out bearings, slipping of clutches will result. Open drains and wash clutches and compartments as follows:

(1) **LUBRICATE THROW-OUT BEARINGS.** Use pressure gun and fill throw-out bearings with grease.

(2) **INSTALL PIPE PLUGS IN DRAIN HOLES.**

(3) **POUR CLEANING FLUID INTO COMPARTMENTS.** Remove steering clutch inspection covers and pour five gallons of fuel oil into each compartment.

(4) **WASH COMPARTMENTS.** Start engine and run tractor backward and forward for several minutes without releasing either steering clutch. Stop tractor and drain compartments.

(5) **WASH CLUTCHES.** Install drain plugs again and pour same amount of fuel oil into each compartment. Operate tractor with no load for five minutes, releasing both steering clutches as often as possible. Drain compartments.

(6) **LUBRICATE MECHANISM.** The steering clutch throw-out bearings and mechanisms should be lubricated after the steering clutches are washed out, as all lubricant will have been washed out. Since it is possible that some fuel oil might drain from the steering clutch compartments into the final drive gear cases during the process of washing, the final drive gear cases should be drained, flushed, and refilled with new oil after the steering clutches are washed.

b. **Lubrication.** The bell crank pivot pins (fig. 17) are provided with pressure gun grease fittings and should be lubricated every 8 hours

HEAVY TRACTOR M1

of operation. Flexible grease tubes from the bearings on the throw-out forks extend through the top of the transmission case, and these bearings should be lubricated every 8 hours through the fittings on these tubes. Do not use other than a hand gun for lubricating these points, as over-lubrication may get grease on the steering clutch disks.

Section XX

TRACTOR BRAKES

| | Paragraph |
|------------------------|-----------|
| Description | 114 |
| Brake adjustment | 115 |

114. DESCRIPTION.

a. The brake system on the tractor consists of lined bands which encircle the brake drums and are operated by the two foot pedals. The brakes are used in conjunction with the steering clutch levers for making short turns. Lever locks are provided to hold the brakes in applied or locked position for parking purposes.

115. BRAKE ADJUSTMENT.

a. The brake bands are one-piece bands installed with the two ends of the band towards the rear of the tractor. A post at the front of the steering clutch and brake compartment of the transmission case engages a socket on the back of the brake band and supports the band on that side. Two adjustments are required, one to adjust the lower half of the band, the other to adjust the upper half.

b. The adjusting nut, shown in figures 118 and 119, controls the adjustment of the upper band. The adjusting screw, also shown in the figures 118 and 119, control the adjustment of the lower band. *It is very important that both the adjusting nut and adjusting screw be used when making adjustment as follows:*

SCREWDRIVER, large (2) WRENCH, open-end, 3/4-in.

(1) REMOVE COVERS FROM REAR OF TRANSMISSION CASE.

WRENCH, open-end, 3/4-in.

Remove the four cap screws from each cover and remove the cover.

(2) ALWAYS ADJUST THE LOWER HALF OF BAND FIRST.

SCREWDRIVER, large (2)

Pry the adjusting screw lock up off the adjusting screw far enough to disengage the V-locking notches in the spring and screw and hold in that position with one screwdriver. Turn the screw to the right or clockwise to tighten the brake by pushing on the corners of the screw head with the other screwdriver. This raises the lower half of the band. Raise the band to the point where it almost touches the drum and yet can be moved sideways on the drum easily with the hand. About 1/64-inch clearance is desired. When this is done be sure the V-notches in the screw head are in a position where the V's in the lock will drop into them when it is lowered. The cap screw above the adjusting screw spring should always remain tight. It has no part in adjustments.

TRACTOR BRAKES

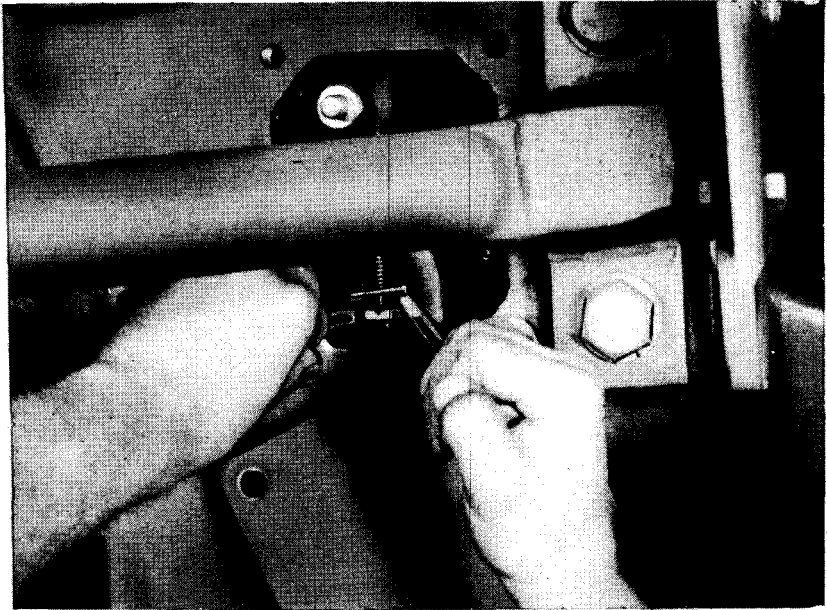

RA PD 17609

Figure 119—Adjusting Brakes

(3) ADJUST THE UPPER HALF OF BAND.

WRENCH, open-end, $\frac{3}{4}$ -in.

Turn the adjusting nut to the right (clockwise) to lower or tighten the upper half of the band, bringing it closer to the drum. This half of the band should also have $\frac{1}{64}$ -inch clearance between it and the drum (measured at top of drum). Test by moving the band sideways with the hand.

(4) TEST THE FREE FOOT PEDAL TRAVEL. Drive tractor forward in second gear at full throttle and push down on the foot pedal to see how far the pedal can be depressed. If the pedal cannot be pressed two-thirds of the way to the floor, the brakes are too tight and will heat. Back the adjusting screw up one-half turn and the adjusting nut one full turn. Test again and repeat backing off the adjusting screw and nut as above until the desired free pedal travel is obtained.

(5) INSTALL COVERS.

WRENCH, open-end, $\frac{3}{4}$ -in.

Install covers on rear of transmission case with the four cap screws provided for each cover.

HEAVY TRACTOR M1

Section XXI

FINAL DRIVES

| | Paragraph |
|---------------------------------------|-----------|
| Description | 116 |
| Lubrication | 117 |
| Sprocket hub bearing adjustment | 118 |

116. DESCRIPTION.

a. The large final drive gear is mounted on a splined hub driven by a small final drive pinion and shaft. The hub rotates on tapered roller bearings on the sprocket shaft and the drive sprocket is bolted to a flange on the hub. Two seal assemblies in each final drive assembly guard against the entrance of dirt and water and prevent oil from escaping. Each oil seal assembly consists of two finely machined steel rings, one turning with sprocket and one held stationary. A spring arrangement holds the two seal rings tightly against each other so that dirt or oil cannot pass between them, thus forming a seal.

117. LUBRICATION.

a. SAE 90, OIL, transmission, is used to lubricate the final drive assembly. The *oil level* should be maintained level with the final drive filler plug. Inspection should be made after every 8 hours of operation to see if oil is at this level. The final drive cases should be drained and refilled with new oil after every 240 hours of operation. The magnetic drain plug is designed to catch small metal particles that might chip off or wear off during operation. This plug should be cleaned off and magnetism tested each time final drive gear cases are drained.

118. SPROCKET HUB BEARING ADJUSTMENT.

a. The sprocket hub bearings should be adjusted periodically. Adjustment procedure is as follows:

WRENCH, hexagon, 1/2-in.

WRENCH, socket, 1 5/16-in.

WRENCH, open-end, 3/8-in.

WRENCH, socket, 1-in.

WRENCH, open-end, 3-in.

(1) REMOVE END COVER.

WRENCH, socket, 1-in.

Remove two cap screws and take off end cover from sprocket shaft bracket.

FINAL DRIVES

(2) REMOVE SPROCKET GUARD.

WRENCH, socket, $\frac{7}{8}$ -in.

WRENCH, socket, $1\frac{5}{16}$ -in.

Remove two bolts holding sprocket guard to truck frame and remove sprocket guard.

(3) LOOSEN CLAMP SCREW.

WRENCH, hexagon, $\frac{1}{2}$ -in.

Loosen clamp screw in sprocket shaft nut.

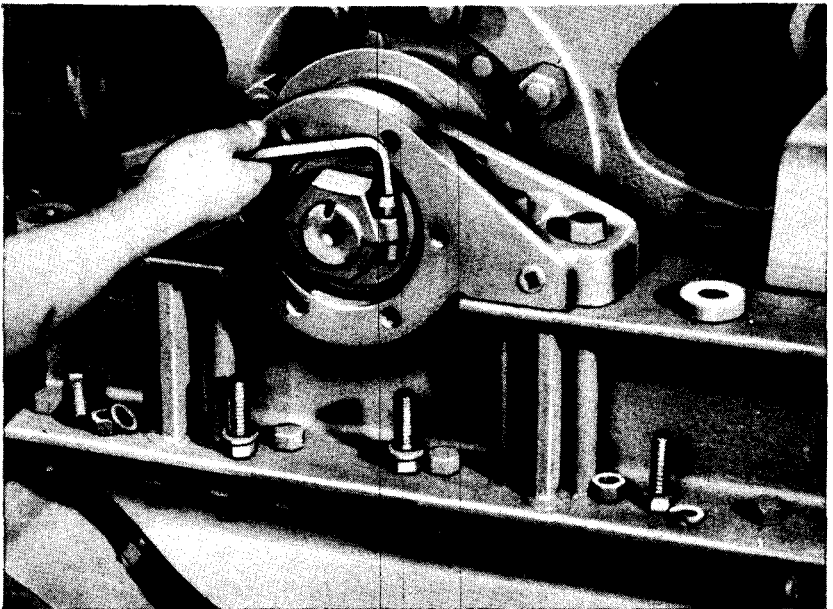

RA PD 17658

Figure 120—Loosening Clamp Screw in Sprocket Shaft Nut

(4) ADJUST BEARINGS.

WRENCH, open-end, 3-in.

Unscrew sprocket shaft nut about 1 inch. Oil threads on axle with engine oil. Then screw sprocket shaft nut on, until nut touches thrust washer. Tighten clamp screw just enough to keep sprocket shaft nut from spreading while it is tightened. Use a 4-foot extension on wrench and tighten nut until bearings are tight. Back off the sprocket shaft nut one-sixth turn for bearing clearance, and tighten clamp screw.

(5) INSTALL SPROCKET GUARD AND END COVER.

HEAVY TRACTOR M1

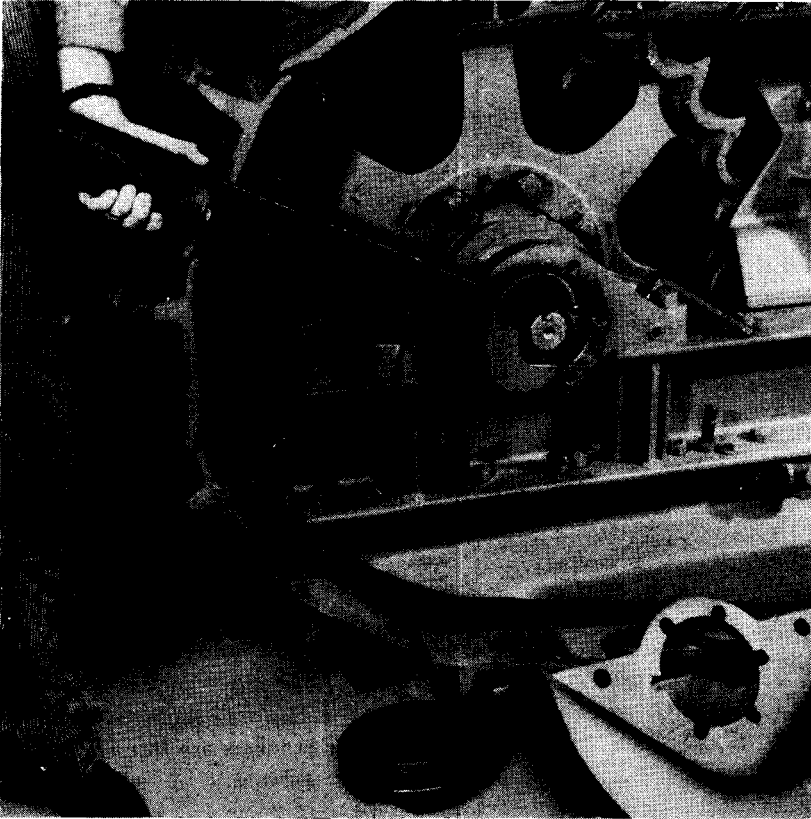

RA PD 17659

Figure 121—Adjusting Sprocket Hub Bearings

Section XXII

TRACKS AND TRUCK FRAME ASSEMBLY

| | Paragraph |
|---|-----------|
| Description | 119 |
| Track release mechanism | 120 |
| Truck wheels | 121 |
| Track support rollers | 122 |
| Removal and installation of pintle drawbar assembly | 123 |

119. DESCRIPTION.

a. The track assembly includes track rails and shoes. The street plates are accessories installed on tracks to prevent damage to road surfaces. The pins and bushings in track rails are of hardened steel and are pressed into the track rails. The master pin is a little longer than the other pins. When necessary to remove track assembly, this pin is ordinarily removed to split the tracks. The 20-inch track shoes are bolted to rails with special hardened bolts and street plates are bolted to the shoes.

b. The truck frame assembly includes the truck frame, track release mechanism, front idlers, truck wheels, and track support rollers. The truck wheels, five on each side, carry the weight of the tractor, except when crossing obstacles, when part of the weight of the tractor may be supported on the front idlers and sprockets.

120. TRACK RELEASE MECHANISM.

a. **Description.** The track release mechanism contains a bell crank and coil spring assembly which allows front idlers to move back to loosen track and prevent severe strain or breakage if rocks, tree limbs, or other objects should be caught in the track. The idler brackets are free to slide on truck frame. Shims are provided between each side of front idler brackets and track release yoke for track alinement purposes. Adjustment of tracks is made with an adjusting screw in track release yoke.

b. Track Adjustment.

WRENCH, open-end, 7/8-in. WRENCH, socket, 15/16-in.

WRENCH, open-end, 1 1/8-in. WRENCH, track adjusting

(1) LOOSEN CLAMP BOLTS.

WRENCH, open-end, 7/8-in. WRENCH, socket, 15/16-in.

Loosen the nuts on clamp bolts in track release yoke.

(2) ADJUST TRACKS (fig. 123).

WRENCH, track adjusting

Turn the adjusting screw out of the yoke to force the front idler ahead and tighten the track. Turn it into the yoke to allow the idler to move

HEAVY TRACTOR M1

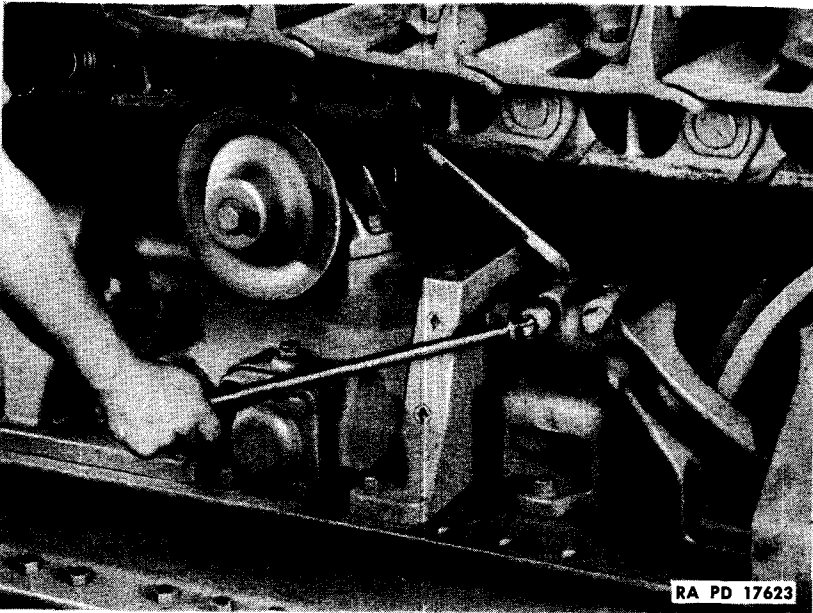

Figure 122—Loosening Clamp Bolts on Track Release Yoke

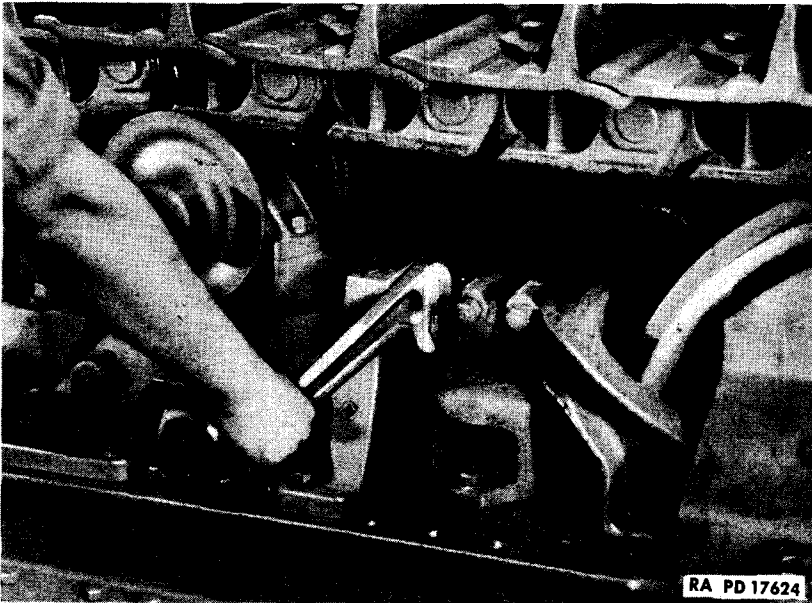
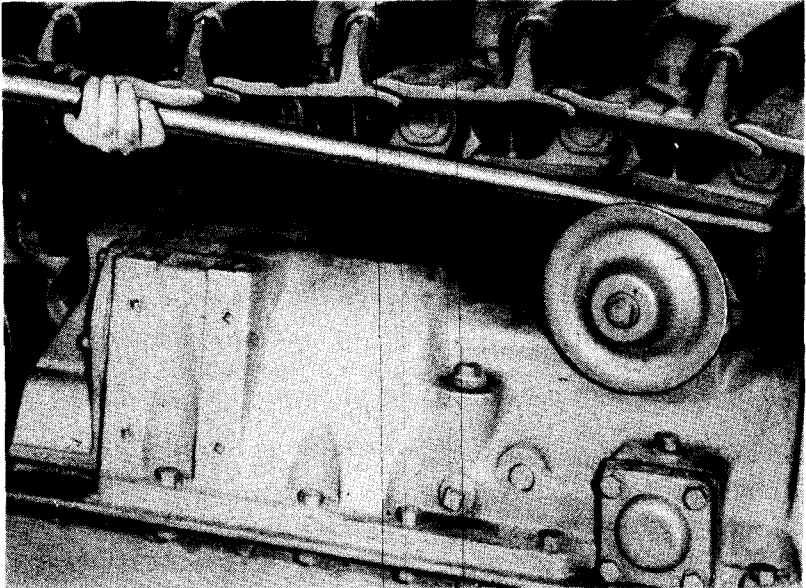

Figure 123—Adjusting Track
216

TRACKS AND TRUCK FRAME ASSEMBLY

back and loosen the track. Track is properly adjusted when it can be lifted about 2 inches off support roller with bar (fig. 124). Drive tractor back and forth a few times after making adjustment. This gives idlers a chance to move out if brackets are binding on truck frame. Then check adjustment again with bar. If driving the tractor back and forth makes no change in track tension, tighten the clamp bolts in track release yoke.



RA PD 17661

Figure 124—Testing Track Adjustment

(3) **CHECK TRACK ALINEMENT.** Observe if inside of track rail is rubbing on either flange of front idler. If it is, the idler should be alined.

(4) **ALINE FRONT IDLER.**

WRENCH, open-end, 1 1/8-in.

WRENCH, socket, 7/8-in.

Remove four cap screws from each guard and lift off idler guards. Remove two cap screws from each idler bracket holding track release yoke to brackets. Change correct amount of shims from one side to the other to aline front idler and give equal clearance between each flange and inside of rail. Install cap screws in yoke and install idler guards.

121. TRUCK WHEELS.

a. **Description.** The truck wheels are equipped with tapered roller bearings and positive oil seals. The positive oil seals prevent dirt or

HEAVY TRACTOR M1

water from entering wheels and oil from leaking out. The seal assemblies consist of fine machined steel rings, one held stationary and one turning with wheel, held so tightly against each other with synthetic rubber seal boots that oil or dirt cannot pass between them. Three truck wheels on each side have flanges on outside only, two have double flanges.

b. Removal.

- | | |
|--------------------------------------|--------------------------------------|
| BLOCK, wood, 8 x 8 in. (2) | WRENCH, socket, $1\frac{5}{16}$ -in. |
| WRENCH, open-end, $\frac{7}{8}$ -in. | WRENCH, socket, $1\frac{1}{8}$ -in. |
| WRENCH, open-end, 1-in. | WRENCH, track adjusting |

(1) LOOSEN TRACKS.

- | | |
|--------------------------------------|-------------------------|
| WRENCH, open-end, $\frac{7}{8}$ -in. | WRENCH, track adjusting |
| WRENCH, socket, $1\frac{5}{16}$ -in. | |

Loosen clamp bolts holding track adjusting screw. Turn screw into track release yoke until track sags (figs. 122, 123, and 124).

(2) DRIVE TRACTOR UP ON BLOCKS.

- BLOCK, wood, 8 x 8 in. (2)

Drive tractor forward on first block so that block will be slightly back of front idler. Then back tractor onto second block and track will sag to ground (fig. 125).

(3) REMOVE TRUCK WHEEL GUARD.

- | | |
|-------------------------|-------------------------------------|
| WRENCH, open-end, 1-in. | WRENCH, socket, $1\frac{1}{8}$ -in. |
|-------------------------|-------------------------------------|

Remove the ten nuts from bolts holding outside truck wheel guard to truck frame and remove guard.

(4) REMOVE TRUCK WHEEL ASSEMBLY.

- | | |
|-------------------------|-------------------------------------|
| WRENCH, open-end, 1-in. | WRENCH, socket, $1\frac{1}{8}$ -in. |
|-------------------------|-------------------------------------|

Remove four bolts holding truck wheel brackets to truck frame. Tap brackets with hammer or pry down with small bar. Truck wheel assembly will drop from frame (fig. 125) and can be removed. NOTE: In some cases, it may be necessary to loosen bolts holding inside truck wheel guard.

c. Installation.

- | | |
|--------------------------------------|-------------------------------------|
| WRENCH, open-end, $\frac{7}{8}$ -in. | WRENCH, socket, $1\frac{1}{8}$ -in. |
| WRENCH, open-end, 1-in. | WRENCH, track adjusting |
| WRENCH, socket, $1\frac{5}{16}$ -in. | |

(1) INSTALL TRUCK WHEEL ASSEMBLY IN FRAME.

- | | |
|-------------------------|-------------------------------------|
| WRENCH, open-end, 1-in. | WRENCH, socket, $1\frac{1}{8}$ -in. |
|-------------------------|-------------------------------------|

Place truck wheel in position, inserting inside end of truck wheel through slot in inside truck wheel guard. Hold brackets against frame and install bolts through frame and brackets. NOTE: End of truck

TRACKS AND TRUCK FRAME ASSEMBLY

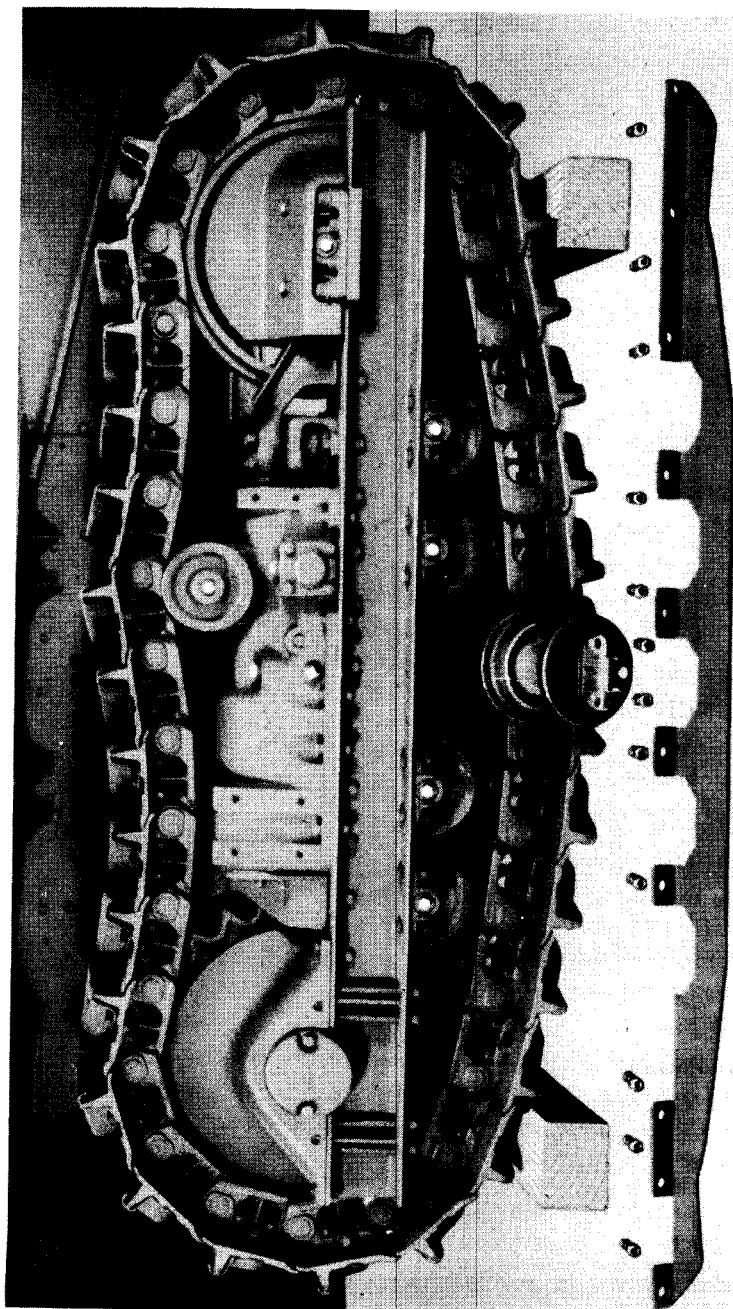

RA PD 17230

Figure 125—Truck Wheel Removed

HEAVY TRACTOR M1

wheel with plug should be outside. Counting from front of frame, track wheels 1-3-5 are single-flanged; 2-4 double-flanged.

(2) INSTALL TRUCK WHEEL GUARD.

WRENCH, open-end, 1-in. **WRENCH**, socket, 1½-in.

Place guard in position and install bolts.

(3) DRIVE TRACTOR OFF BLOCKS AND ADJUST TRACKS (par. 120 b).

WRENCH, open-end, ⅞-in. **WRENCH**, track adjusting
WRENCH, socket, 1⅝-in.

122. TRACK SUPPORT ROLLERS.

a. Description. The track support rollers and the truck wheels are of similar construction. They are double-flanged rollers, supported on brackets on top of the track release housings. Instead of having two brackets on the ends of the shaft as the truck wheels, the track support roller has one bracket in the center which is bolted to the support bracket.

b. Removal.

JACK **WRENCH**, socket, 1-in.

(1) RAISE TRACK.

JACK

Set jack on track release housing and jack track up, off support roller far enough to allow removal of roller.

(2) REMOVE ROLLER.

WRENCH, socket, 1-in.

Remove the two cap screws holding roller to support bracket and lift off roller assembly.

c. Installation.

JACK **WRENCH**, socket, 1-in.

(1) INSTALL ROLLER ASSEMBLY.

JACK

With jack on track release housing holding up center of track, install roller in position and install cap screws and lock washers. Remove jack.

123. REMOVAL AND INSTALLATION OF PINTLE DRAWBAR ASSEMBLY.

BAR, pry **WRENCH**, ⅞-in.
BAR, 3-ft **WRENCH**, 1⅝-in.
HAMMER, 2-lb **WRENCH**, 1⅞-in.
PLIERS **WRENCH**, 2½-in.
PUNCH, small

TRACKS AND TRUCK FRAME ASSEMBLY

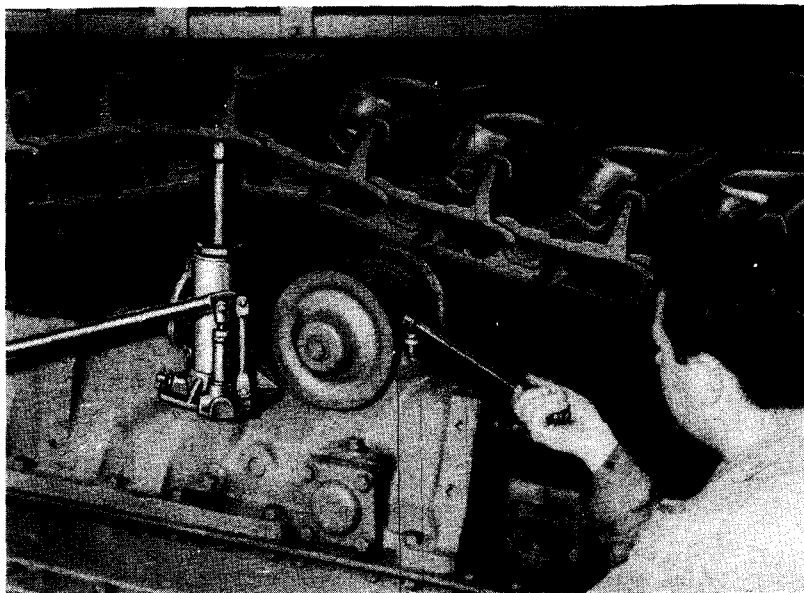

RA PD 17627

Figure 126—Removing Track Support Roller

a. Procedure.

(1) REMOVE DRAWBAR BOLTS.

PLIERS

WRENCH, 1 $\frac{7}{16}$ -in.

WRENCH, 1 $\frac{5}{16}$ -in.

Remove cotter pins from bolts holding rear of drawbar to drawbar plate (pliers). Remove the two bolts (1 $\frac{5}{16}$ - and 1 $\frac{7}{16}$ -in. wrenches).

(2) REMOVE PIVOT PIN.

BAR, pry

WRENCH, $\frac{7}{8}$ -in.

Remove cap screw underneath tractor at front end of drawbar (fig. 128) holding pivot pin retainer ($\frac{7}{8}$ -in. wrench) and remove retainer. Screw the retainer cap screw into bottom of pivot pin (fig. 129) and pry pivot pin out (pry bar).

(3) REMOVE PINTLE FROM DRAWBAR.

BAR, 3-ft

PUNCH, small

HAMMER, 2-lb

WRENCH, 2 $\frac{1}{2}$ -in.

Remove large cotter pin from pintle nut (hammer and punch). Hold pintle from turning with bar and remove pintle nut (2 $\frac{1}{2}$ -in. wrench). Pull pintle from drawbar. **NOTE:** If pintle only is to be removed, hold nut from turning with wrench and turn pintle shaft out of nut with bar.

HEAVY TRACTOR M1

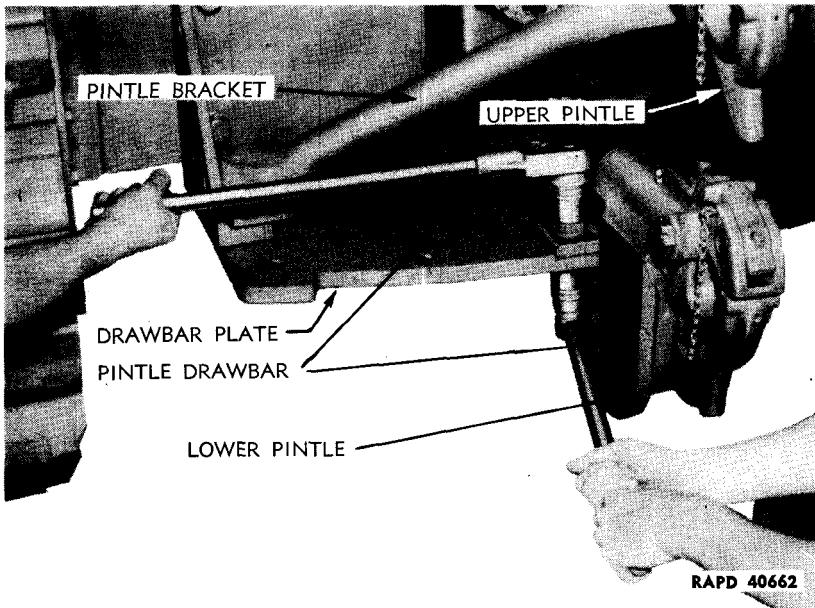

Figure 127—Removing Bolts from Pintle Drawbar

(4) REMOVE PINTLE DRAWBAR FROM TRACTOR.

WRENCH, $\frac{7}{8}$ -in.

Remove pivot pin retainer with $\frac{5}{8}$ x $1\frac{1}{4}$ -inch cap screw with lock washer. Remove pivot pin from recess in transmission case and pull drawbar from tractor (see fig. 129).

b. Installation of Pintle Drawbar Assembly.

BAR, 3-ft

WRENCH, $1\frac{5}{16}$ -in.

PLIERS

WRENCH, $1\frac{7}{16}$ -in.

WRENCH, $\frac{7}{8}$ -in.

WRENCH, $2\frac{1}{2}$ -in.

(1) PROCEDURE.

(a) Install Pintle Drawbar.

WRENCH, $\frac{7}{8}$ -in.

Place drawbar in position on plate and insert pivot pin into recess in transmission case. Install pivot pin retainer with $\frac{5}{8}$ x $1\frac{1}{4}$ -inch cap screw with lock washer (fig. 129).

(b) Install Bolts in Drawbar.

WRENCH, $1\frac{5}{16}$ -in.

WRENCH, $1\frac{7}{16}$ -in.

Insert the two 1- x 4-inch bolts through rear of drawbar and drawbar plate, place nuts on bolts, tighten nuts, and install cotter pins through bolts.

TRACKS AND TRUCK FRAME ASSEMBLY

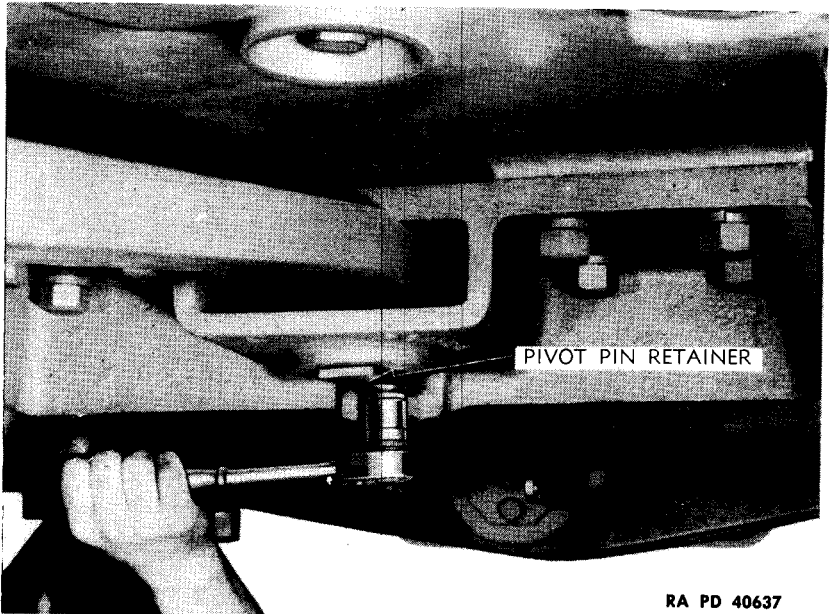

Figure 128—Removing Retainer Cap Screw

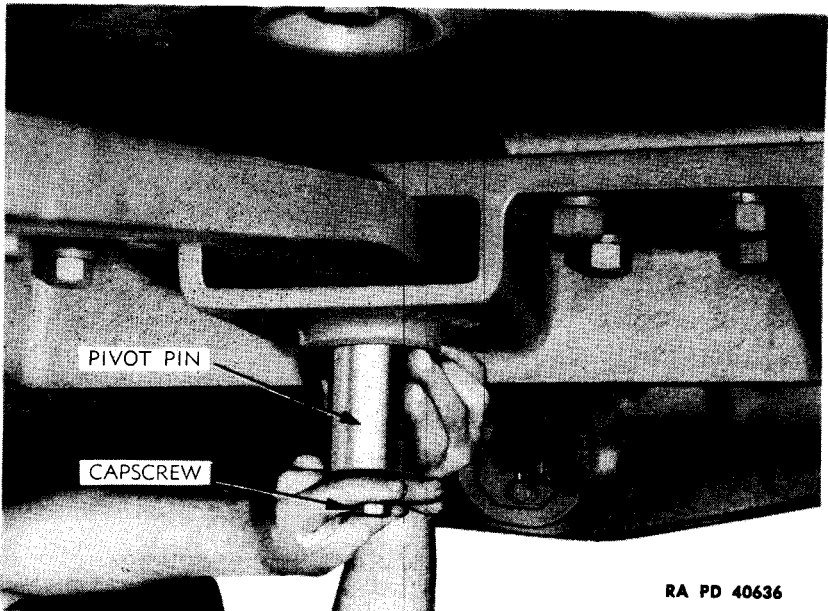

Figure 129—Removing Pivot Pin

HEAVY TRACTOR M1

(c) Install Pintle.

BAR, 3-ft
PLIERS

WRENCH, 2½-in.

Insert pintle through hole in drawbar and start nut on pintle. Hold pintle from turning with bar and tighten nut (2½-in. wrench). Install cotter pin through pintle shaft and nut (pliers).

c. Removal of Pintle Bracket Assembly.

BAR, 3-ft
HAMMER, 2-lb
PUNCH, small
WRENCH, 1⅝-in., with long extension

WRENCH, 1⅞-in.
WRENCH, 2½-in.

(1) PROCEDURE.

(a) Remove Upper Pintle.

BAR, 3-ft
HAMMER, 2-lb

PUNCH, small
WRENCH, 2½-in.

Remove cotter pin from nut (hammer and punch). Hold nut with 2½-inch wrench and turn shaft pintle out of nut with bar through hook. Slide pintle out of bracket.

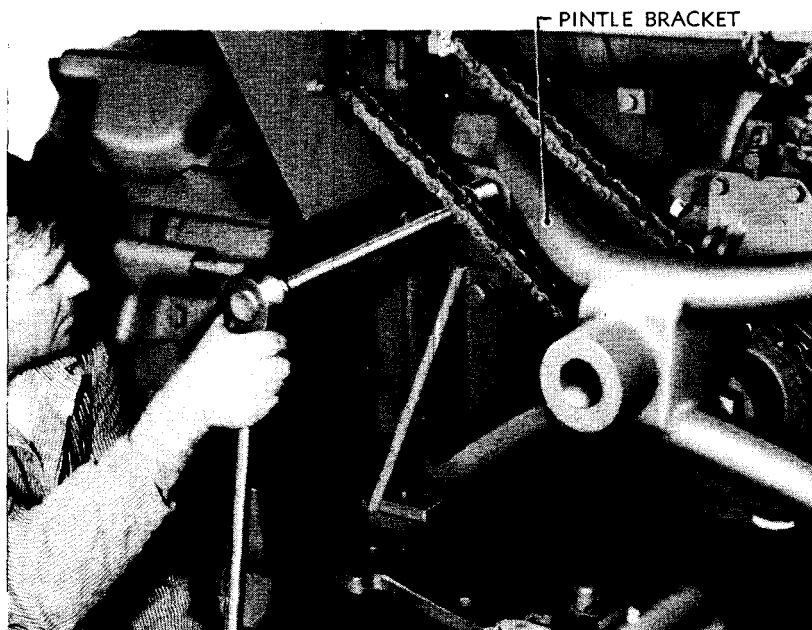

RA PD 53974

Figure 130—Removing Pintle Bracket

TRACKS AND TRUCK FRAME ASSEMBLY

(b) Remove Pintle Bracket.

WRENCH, socket, $1\frac{5}{16}$ -in.,
with long extension

WRENCH, $1\frac{7}{16}$ -in.

Remove four bolts holding lower arms of bracket to drawbar plate and brace ($1\frac{5}{16}$ and $1\frac{7}{16}$ -in. wrenches). Remove the four cap screws holding upper arms to rear of transmission case ($1\frac{5}{16}$ -in. wrench with extension.) and lift off bracket.

d. Installation of Pintle Bracket Assembly.

BAR, 3-ft

WRENCH, $1\frac{7}{16}$ -in.

PLIERS

WRENCH, 2 $\frac{1}{2}$ -in.

WRENCH, $1\frac{5}{16}$ -in.,
with long extension

(1) PROCEDURE.

(a) Install Bracket.

WRENCH, $1\frac{5}{16}$ -in.,
with long extension

WRENCH, $1\frac{7}{16}$ -in.

Set bracket in place. Install four 1- x 3-inch cap screws with lock washers through upper bracket arms and into rear of transmission case ($1\frac{5}{16}$ -in. wrench). Install four bolts with lock washers through lower bracket arms and drawbar plate and brace. Install lock washers and nuts and tighten ($1\frac{5}{16}$ and $1\frac{7}{16}$ -in. wrenches).

(b) Install Pintle.

BAR, 3-ft

WRENCH, 2 $\frac{1}{2}$ -in.

PLIERS

Insert shaft in bracket. Start nut and hold with 2 $\frac{1}{2}$ -inch wrench. Insert bar through hook and turn shaft into nut. Install cotter pin through nut and shaft and bend ends (pliers).

HEAVY TRACTOR M1

Section XXIII

WINCH AND POWER TAKE-OFF

| | Paragraph |
|-------------------|-----------|
| Description | 124 |
| Maintenance | 125 |

124. DESCRIPTION.

a. **Winch.** The winch, with 300 feet of $\frac{3}{4}$ -inch cable, is mounted on front of tractor and is driven by the power take-off on rear of tractor. Drive shafts, supported in ball bearings on side of tractor, run from rear of tractor to winch gear case. The drum is driven by a worm and gear through a jaw clutch. This gear reduction makes possible the maximum pull on cable. The jaw clutch is engaged and disengaged by a control lever on right fender. The winch drum brake used for controlling drum is operated by a lever on right fender of tractor. There is also an automatic brake assembly on winch worm shaft. All tractors are being equipped with winch guards and bumpers to protect the winch from damage by trees and other obstructions.

b. **Power Take-Off.** The power take-off is driven by the top transmission shaft. A splined coupling connects transmission shaft to power take-off shaft. The power take-off is of the reversible type and can turn winch drum for unwinding cable from drum as well as for winding cable on drum. The shifter shaft is operated by a control lever ahead of operator's seat for putting power take-off in winding, unwinding, or neutral position.

125. MAINTENANCE.

a. The winch gear case and power take-off housing should be kept filled with lubricant to level of the oil level plugs. End frame bearing and winch drive shaft bearings and universals should be lubricated after every eight hours of operation of the winch. The breather cap on top of power take-off housing should be washed periodically in clean fuel oil. Winch drum brake and automatic winch worm shaft safety brake should be kept in adjustment. The winch drum brake will require very little adjustment. If adjustment is required, the brake may be tightened or loosened by shortening or lengthening the control rod running back to the control lever on the fender. If automatic winch worm shaft safety brake fails to hold load when winch is stopped, adjust as follows:

b. Adjustment of Winch Worm Safety Brake.

WRENCH, open-end, $\frac{3}{4}$ -in.

WRENCH, socket, $\frac{3}{4}$ -in.

WRENCH, socket, $\frac{9}{16}$ -in.

WINCH AND POWER TAKE-OFF

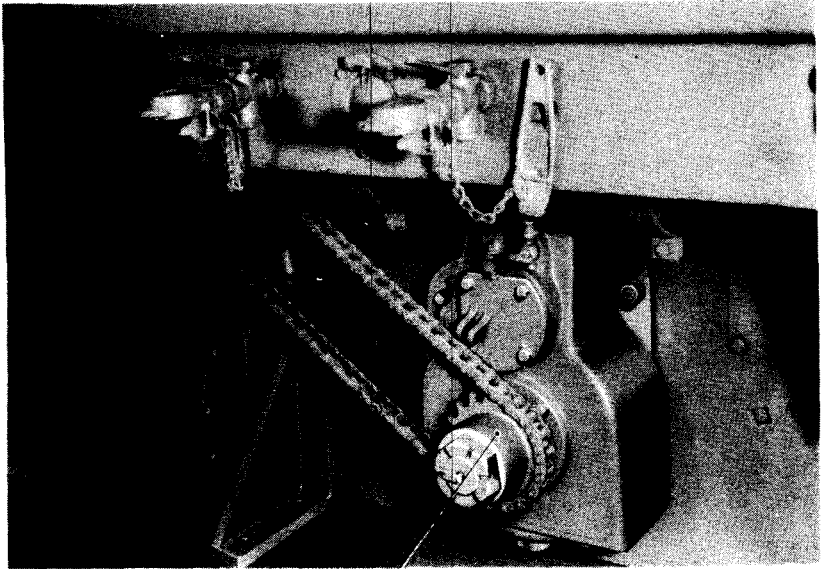

RA PD 56396

Figure 131—View of Power Take-Off Unit

(1) REMOVE GUARD.

WRENCH, open-end, $\frac{3}{4}$ -in. WRENCH, socket, $\frac{3}{4}$ -in.

Remove three cap screws and two bolts and remove guard.

(2) REMOVE COVER FROM GEAR CASE.

WRENCH, socket, $\frac{5}{16}$ -in.

Remove six cap screws and remove cover.

(3) ADJUST BRAKE.

WRENCH, open-end, $\frac{3}{4}$ -in.

Refer to figure 132. Tighten nut "A" on brake spring one-half turn, tighten lock nut and test brake. Tighten another one-half turn if brake still fails to hold load when winch is stopped. CAUTION: Do not tighten more than necessary as brake will run hot and lining of brake band will wear excessively as a result. A clearance of $\frac{1}{8}$ -inch should be maintained between nut and shoulder at point "B". This clearance can be adjusted with the two nuts "C".

(4) REPLACE GEAR CASE COVER AND GUARD.

c. Removal of Cable.

WRENCH, socket, $\frac{3}{4}$ -in.

HEAVY TRACTOR M1

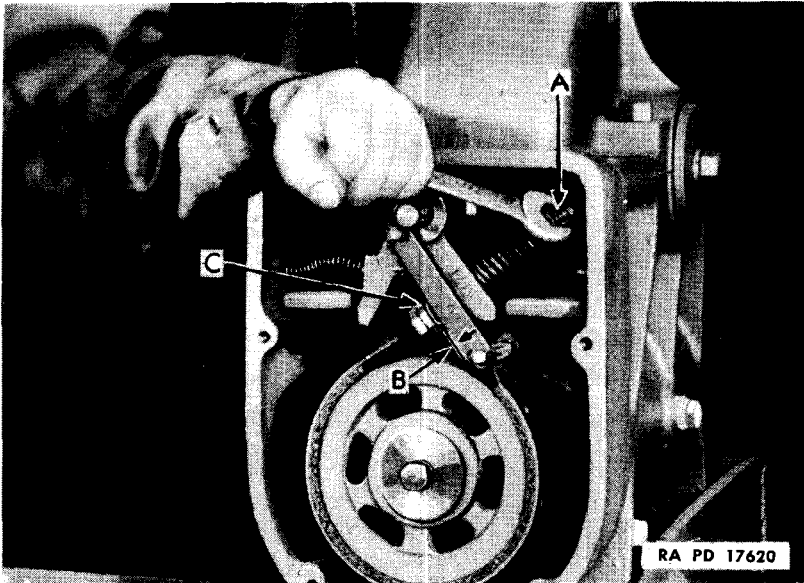
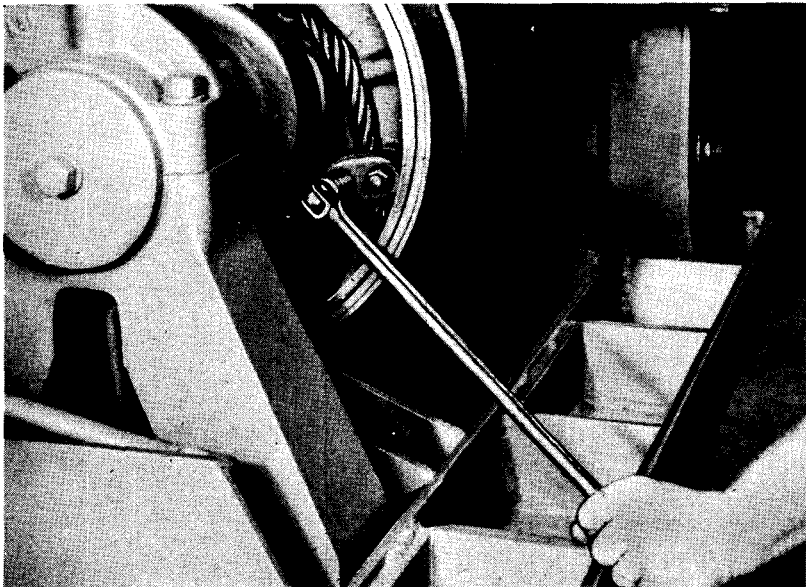

Figure 132—Adjusting Automatic Winch Brake



RA PD 17669

Figure 133—Removing Cable Clamp

WINCH AND POWER TAKE-OFF

(1) **UNREEL CABLE FROM DRUM.** Unreel balance of cable if any is remaining on drum.

(2) **REMOVE CLAMPS.**

WRENCH, socket, $\frac{3}{4}$ -in.

Remove the two nuts and clamp from end of cable and pull end of cable out through hole in flange of drum.

d. Installation of Cable.

WRENCH, socket, $\frac{3}{4}$ -in.

(1) **INSTALL CABLE.**

Start end of cable underneath drum, and around the drum to the hole in flange of drum. Pull about 8-inches of cable through hole.

(2) **INSTALL CLAMP.**

WRENCH, socket, $\frac{3}{4}$ -in.

Place clamp over cable, install the clamp nuts and tighten, having about 2 inches of cable extending through clamp.

(3) **WIND CABLE ON DRUM.** Start engine and wind cable on drum. Keep cable taut while winding and lay each coil tightly against the one before it.

HEAVY TRACTOR M1

Section XXIV

STORAGE AND SHIPMENT

| | Paragraph |
|---|-----------|
| General | 126 |
| Limited storage | 127 |
| Placing vehicles in dead storage | 128 |
| Removing vehicles from dead storage | 129 |
| Preparation for shipment | 130 |
| Crating | 131 |
| Loading | 132 |

126. GENERAL.

a. **Selection of Storage Site.** All motor vehicles not in use will be stored in covered or closed buildings whenever practicable. If exterior storage is necessary, the best available surface will be selected, taking into consideration, firmness, smoothness and drainage of terrain. Except when a tactical situation requires concealment, parking under low hanging limbs of trees will be avoided.

b. **Preparation for Storage.** Before being stored the vehicle and its equipment will be thoroughly cleaned, lubricated and inspected. (secs. IV, V, and VI.) When practicable the vehicles will be promptly repaired and placed in good operating condition. If repairs can not be made prior to placing of vehicles in storage, a tag will be attached to the steering lever specifying the repairs needed, and a written report of these items will be made to the officer in charge of the vehicles.

c. **Spacing of Vehicles in Park.** Sufficient space should be allowed between vehicles to provide accessibility for the routine inspections and servicing prescribed. Excessive spacing will be avoided in order to conserve space.

d. **Severe Conditions.** Special precautions should be taken for such severe conditions as: Extreme temperatures, rapid change of temperature, humid or arid climate, dust, salty spray, corrosive vapors from nearby industrial plants, or other harmful conditions.

127. LIMITED STORAGE.

a. **Definition.** Vehicles in limited storage are those temporarily out of service for less than 30 days, or vehicles that must be ready for operation on call.

b. **Preparation for Limited Storage.**

(1) **BATTERIES.**

STORAGE AND SHIPMENT

(a) Batteries that show signs of corrosion will be removed and cleaned as follows: After plugging the vents in the cells, the battery case will be cleaned with a solution of soda ash or baking soda and water to neutralize the acid. The concentration of soda ash will be eight ounces per gallon of water; if baking soda is used, the concentration will be one pound per gallon of water. After this treatment the case should be flushed with cold water. Do not use hot water or steam. Remove plugs from the vents after cleaning. Terminals and cable ends will be thoroughly cleaned with neutralizing solution and scraped clean with suitable tool or wire brush.

(b) Terminals of all batteries will be coated with COMPOUND, rust-preventive, light. Hydrometer readings of each cell will also be taken. Distilled water or its nearest equivalent will be added to cover the plates, but not in excess of $\frac{3}{8}$ inch above separators. If hydrometer readings are 1.225 or less, the battery will be charged.

(c) If subzero temperatures are anticipated a higher state of charge, suitable for the anticipated temperature will be maintained.

(2) COOLING SYSTEM. If freezing temperature is normally expected during the storage period, the coolant will be tested with an antifreeze hydrometer and the proper quantity of antifreeze will be added to afford protection from freezing at the lowest temperature anticipated during the storage period. (par. 136). The cooling system will be inspected for leaks.

(3) ROAD TESTS. The preparation for storage will include a road test of at least 5 miles after the battery and cooling system service to check on general condition of the vehicle. Any defects discovered will be corrected or noted as specified paragraph 126 b.

(4) ENGINE. The engine will be prepared for storage as follows:

(a) Check the engine oil and replenish, if necessary. Use the recommended grade for temperatures anticipated during storage period. (sec. IV or XXV).

(b) Drain fuel tank.

(c) Prepare a mixture of 20 percent OIL, lubricating, preservative, medium, and 80 percent Diesel fuel. Prepare enough of this mixture to operate the vehicle for 15 minutes. Pour mixture into fuel tank and run the engine at fast idle for 15 minutes.

(d) Drain the fuel system.

(5) BRAKES. Brakes will be released and the tracks chocked. Air tank will be thoroughly drained by fully opening drain cock. When no water shows in air stream, close drain cock tightly.

(6) EXTERIOR.

HEAVY TRACTOR M1

(a) Rust appearing on any part of the vehicle before storage will be removed with sandpaper. Painted surfaces will be repainted wherever necessary to protect the metal.

(b) Exposed polished metal surfaces susceptible to rust will be coated with OIL, lubricating, preservative, medium.

(c) Winch, cables and chains will be coated with OIL, lubricating, preservative, medium.

(d) Equipment such as pioneer and truck tools, street plates and fire extinguishers will remain in place in the vehicle.

(7) AIR COMPRESSOR. Check oil level, replenish if necessary. Use the recommended grade for temperatures anticipated during storage period.

c. Inspections in Limited Storage.

(1) Vehicles in limited storage will be inspected weekly with the following as a minimum:

(a) Repeat the battery service described in *b* (1) above. If water is added when freezing weather is anticipated, recharge the battery with a portable charger or remove the battery for charging. Do not attempt to charge the battery by running the engine.

(2) Vehicles in "On call" limited storage for more than 30 days will receive the following service at monthly intervals, in addition to the weekly inspection.

(a) Remove the oil filler cap, fill fuel tank and start the engine. Observe the oil pressure gage. If pressure is registered, shut off the engine and report this fact to the officer in charge. If no oil pressure is registered, allow the engine to idle. When the radiator temperature reached 180 F (if necessary cover the radiator to obtain this temperature) advance the throttle to a fast idle, not to exceed 800 revolutions per minute and allow the engine to continue running at this speed and temperature for 30 minutes. After shutting off the engine install the oil filler cap. CAUTION: If the cooling system contains a volatile antifreeze, the amount of liquid will be checked every 5 minutes and more added if necessary.

(b) Repeat the cooling system service outlined in *b* (2) above.

(c) Repeat the engine service outlined in *b* (4) above.

(d) Repeat to the extent required, the exterior service outlined in *b* (6) above.

d. Inspection When Removed from Limited Storage. Upon removal from storage any item noted by a tag attached to the steering lever as still needing repair (par. 126 b) will be repaired and the vehicle will be given a complete monthly maintenance inspection, plus any repairs which this inspection shows necessary.

STORAGE AND SHIPMENT**128. PLACING VEHICLES IN DEAD STORAGE.**

a. **Definition.** Vehicles in dead storage are those that will not be required for service over an indefinite period exceeding 30 days.

b. Engine.

(1) **CRANKCASE.** The crankcase will be drained while the engine is still warm. The oil will be drained from the engine by removing drain plugs from the crankcase. The oil screen will be removed, cleaned and reinstalled in the engine. Drain plugs will then be reinstalled in the engine. Fill crankcase with one-half charge of OIL, lubricating, preservative, medium. Run engine for 15 minutes at approximately 1,000 revolutions per minute. Leave preservative in crankcase.

(2) **FUEL SYSTEM.** The fuel tank will be drained and the fuel system purged with a mixture prepared as shown below, a quantity of which will remain in the system when the engine is shut down for storage. Proceed as follows:

(a) Prepare a mixture of 20 percent OIL, lubricating, preservative, medium, and 80 percent Diesel fuel.

(b) Drain and clean fuel filters and fuel tanks.

(c) Place approximately two gallons of the fuel oil mixture in tanks and run engine at normal speed until the two gallons of fuel oil mixture are nearly exhausted. Leave the remaining oil in the fuel system.

(3) CYLINDERS.

(a) The cylinder walls, piston heads, and valves will be treated with OIL, lubricating, preservative, medium.

(b) *Remove Injectors.* The engine will be cranked by hand until each piston is placed on bottom center and the inside of that cylinder will be sprayed through injector opening in head with approximately one-eighth pint (2 oz) of OIL, lubricating, preservative, medium. Following the above, the crankshaft will be rotated by hand at least two complete revolutions and the cylinder space above each piston will be resprayed with approximately one-sixteenth pint (1 oz) of the OIL, lubricating, preservative, medium. Do not rotate the crankshaft after this treatment.

(c) *Injector.* (1) The injectors will be removed and cleaned while the valves and cylinders are being treated with the preservative. Clean injectors in SOLVENT, dry-cleaning. Dry thoroughly and dip in preservative. After the corrosion preventive treatment is completed, coat the injector holes with the preservative and install the injectors in the engine. Care must be taken not to damage the injectors. Diesel engine injectors will remain in the engine during shipping and storage.

HEAVY TRACTOR M1

c. **Valves and Rocker Arms.** Remove rocker arm cover and thoroughly clean interior of cover, rocker arms and control rack. Spray with OIL, lubricating, preservative, medium, while the crankshaft is being rotated, so that the entire surface of the rocker arms, control rack and the protruding ends of the valve stems will be coated thoroughly. Spray the interior of the cover and replace.

d. **Cooling System.** Drain and flush cooling system, including both radiator and engine block (par. 74). Compressed air, if available, will be blown into the outlet passages forcing the moisture down and out of the inlet passage.

e. **Openings.** All coolant passage openings, fuel and oil lines, open connections, or other openings will be coated with preservative. Threaded openings will be coated with preservative. Plug all openings. If tapered plugs are used, they will be so constructed that they cannot be accidentally pushed or driven completely into the openings. If plugs are not available, tubes, or pipes and most other openings can be sealed satisfactorily by covering with a small piece of oiled or waxed paper. Gather the ends of the paper around the tube and tie with cord. The air precleaners can be sealed by covering with a paper bag and tying a cord around the intake stack.

f. **Exterior.**

(1) The exterior of the engine will be thoroughly cleaned and dried. Material used for cleaning must not have a harmful effect on the exterior of the engine. A coating of COMPOUND, rust-preventive, light, will be applied to all unpainted steel parts. Rust appearing on any parts before storage will be removed with sandpaper, and the metal either painted or lightly coated with rust-preventive, COMPOUND, light.

(2) Care must be taken to remove COMPOUND, rust-preventive, light, from exposed rubber and painted parts.

g. **Battery.**

(1) Remove the battery from the vehicle and service as outlined in paragraph 127 b (1).

(2) Place the battery in active stock. Never allow batteries in stock to become discharged below a hydrometer reading of 1.225. This will be a proper precaution against freezing in all but the most severe weather, when a specific gravity of 1.250 will be maintained.

h. **Air Compressor.** Drain lubricating oil at the same time oil in engine crankcase is drained. Replace drain plug and fill with one-half charge of OIL, lubricating, preservative, medium. Run engine for 15 minutes at approximately 1,000 revolutions per minute. Leave preservative in compressor.

STORAGE AND SHIPMENT

i. **Vehicle.** Rust appearing on any part before storage will be removed with sandpaper. Painted surfaces will be repainted and unpainted surfaces will be lightly coated with COMPOUND, rust-preventive, light.

j. **Equipment.**

(1) Release all brakes and chock the tracks.

(2) Depress clutch pedal and place small block of wood between clutch control lever and under side of floor board to hold the clutch out of engagement. The blocks must not be larger than necessary to make sure the clutch faces are separated.

(3) When vehicles are stored in any open location, remove such equipment as pioneer tools, street plates, chains and fire extinguisher. Store them separately. When vehicles are stored in closed or locked buildings, such equipment may remain in place in the vehicles.

k. **Inspections.**

(1) A tag will be attached to the steering lever on which will be recorded the date of all inspections, the initials of the inspectors, and their findings.

(2) Monthly inspections will be made to determine:

(a) Existence and condition of all equipment removed and stored separately.

(b) That parts and equipment have not been removed without proper authority.

(c) If the protective measures are effectively preventing deterioration so that corrective measures can be immediately instituted.

l. **Periodic Treatment of Engine and Vehicle.** At the expiration of each 3-month period, the following treatment should be repeated:

(1) Cylinders. (par. b (3)).

(2) Valves. (par. c).

(3) External metal parts. (par. f).

(4) Vehicle. (par. i).

m. **Unfavorable Climatic Conditions.**

a. For storage in unfavorable climatic conditions, such as might occur in tropical climates, or near sea water, it may be necessary to use an additional precaution to prevent corrosion and rust. If the foregoing treatment is inadequate, the engines and vehicles will be retreated at intervals of 1 month instead of every 3 months.

129. REMOVING VEHICLES FROM DEAD STORAGE.

a. **Cooling System.** When vehicles are removed from dead storage, the cooling system will be flushed to remove loose sediment (par.

HEAVY TRACTOR M1

77 c). New hoses will be installed at this time if required. The cooling system will then be filled with water. If the temperature is below freezing, the required amount of antifreeze to afford adequate protection at the lowest anticipated temperature will be added.

b. **Cylinders.** Excessive preservative oil above the pistons will be removed with hand pump, if available, otherwise remove injectors and turn the engine over by hand to force out the excess oil.

c. **Valves.** Rotate the crankshaft through three or four revolutions by hand and observe the proper operation of valve mechanism. Also observe that excessive preservative oil or other material is not present in the cylinder to cause damage due to hydrostatic obstruction when the engine is turned over. Any valve found to be sticking will have the stem generously lubricated with penetrating oil or with a 50-50 mixture of kerosene and light lubricating oil, such as OIL, lubricating, engine, SAE 10. Continue to turn the engine over by hand until all evidence of sticking valves has been eliminated. If this treatment does not free the valves, necessary mechanical repairs to free them must be made before the engine is placed in service.

d. **Fuel Tank.** Tank will be filled.

e. **Battery.** Install a fully charged battery.

f. **Lubrication.** The remainder of vehicle will be thoroughly lubricated before being placed in service (sec. IV). Gear cases will be drained, flushed and refilled to proper level with the correct lubricant according to seasonal requirements.

g. **Crankcase.** Drain old oil and flush the crankcase using one-half the normal quantity of oil.

h. **Inspection.** A thorough inspection will be made of the vehicle at this time. Any repairs which have been ordered at the time the vehicle was placed in storage, and have not already been performed, must be accomplished at this time. The following special considerations will be observed in accomplishing this inspection:

(1) **BRAKES.**

(a) **General.** It is necessary that the connections of the mechanical linkage have complete freedom of action. In other words, there must not be any parts which may be restricted in their action due to drying out, corrosion, or rusting of movable joints. All clevises, pins, and movable joints should be free and lubricated carefully. Return springs should be checked for their full action and useful life. Movement of brake actuating mechanism will be checked to insure free action. Adjust brakes as outlined in paragraph 115.

(2) **SPROCKET HUB BEARING.** When the period of dead storage has extended over several months, consideration will be given to cleaning

STORAGE AND SHIPMENT

and repacking sprocket hub bearings, and replacing all oil seals. This will be done by ordnance personnel.

(3) **LIGHTS.** Light reflectors will be cleaned and polished when necessary. Check for loose or damaged gaskets.

(4) **OIL FILTERS.** The oil filter element will be replaced in all vehicles which have formerly been in service.

i. **Starting Engine.** If practical, vehicle which is removed from dead storage will, after the proper preparation for service, be towed with high gear engaged until the engine starts. See if the engine runs smoothly. Shut off engine and drain flushing oil while the engine is still warm. Fill the crankcase with the specified grade and quantity of lubricating oil.

130. PREPARATION FOR SHIPMENT.

a. After tractor has been used and before it can be crated and shipped, it must be thoroughly cleaned (par. 44) and inspected. Wash all dirt and grease from vehicle. Make an inspection of entire vehicle for broken parts and tighten all loose bolts. Replace worn bolts that cannot be tightened. Repair or replace broken or missing parts so that tractor will be ready for operation when it reaches destination. Check tools and equipment against the equipment list for tractor.

b. If tractor is to be shipped by rail, nothing on tractor need be removed. If shipment is to be by boat, the tractor must be crated. Crating requires the removal of the precleaners and extension tubes, exhaust tail pipe, pintles, and trailer air brake hose connectors. The cooling system must be drained and battery cables disconnected from battery terminals.

131. CRATING.

a. **Crates.** Figure 134 contains specifications and list of material needed for building crates for this tractor in the event the original crates have been destroyed and new ones have to be made. Drawings show construction of crate and how each section is braced.

b. Crating Tractor.

(1) Drive tractor up onto floor of crate so that there is equal clearance on both ends and both sides of floor. Using eight triangular shaped blocks, nail two blocks at each end of each of the tracks (using two 60-penny and seven 40-penny nails in each block). Drive these chocking blocks tightly against tracks before nailing them down. Nail a block four feet long, four inches high and five inches wide to floor against inside of each track with six 40-penny nails. These blocks will hold tractor from shifting in crate. Place banding iron over front pull hook

HEAVY TRACTOR M1

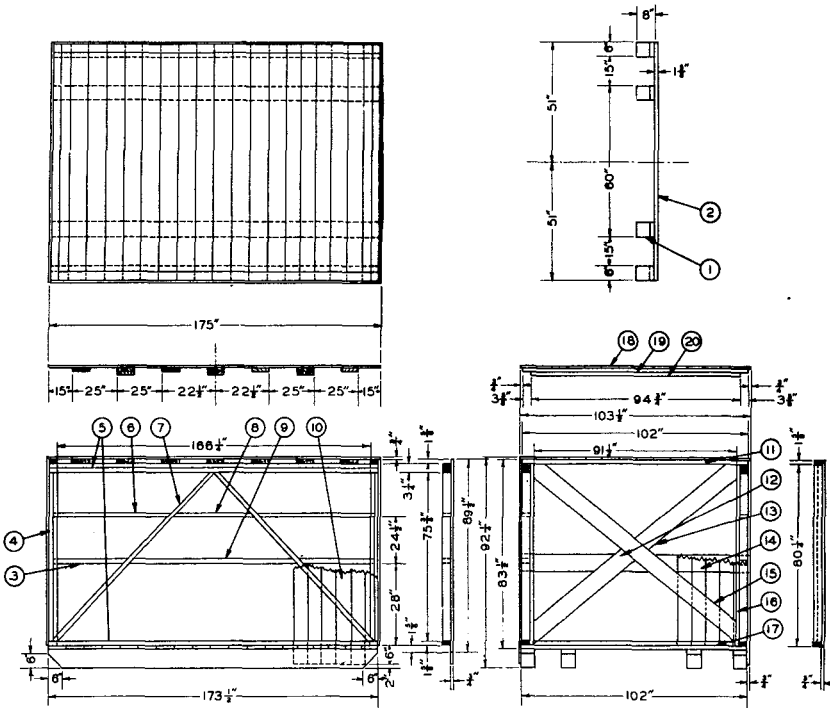

| TOTAL MATERIAL REQUIRED BOARD FEET | | GROUP | ITEM NO. | No. REQ'D. | NAME | STOCK SIZE | MATERIAL | BOARD FEET |
|---------------------------------------|----------------------|----------------------|----------|------------|----------------|---------------------|----------|------------|
| 6" x 8" | OAK | BASE | 1 | 4 | SKIDS | 6 x 8 x 173-1/2 | RED OAK | 232' |
| 2" x 8" | Y.P. | | 2 | 23-1/2 | FLOORING NAILS | 2 x 8 x 102 | Y. P. | 267' |
| 2" x 4" | Y.P. | SIDES 2 REQ'D. | 3 | 4 | BRACE | 2 x 4 x 30-3/4 | Y. P. | 7' |
| 2" x 2" | Y.P. | | 4 | 4 | COLUMNS | 2 x 4 x 75-3/4 | Y. P. | 17' |
| 1" x 6" T.G. | Y.P. | | 5 | 6 | HEADERS | 2 x 4 x 173-1/2 | Y. P. | 58' |
| #8 NAILS | Y.P. | | 6 | 4 | BRACE | 2 x 4 x 57-1/2 | Y. P. | 13' |
| #16 NAILS | Y.P. | | 7 | 4 | "A" BRACE | 2 x 4 x 113-1/4 | Y. P. | 26' |
| #20 NAILS | Y.P. | | 8 | 2 | BRACE | 2 x 4 x 54 | Y. P. | 6' |
| | | | 9 | 2 | BRACE | 2 x 4 x 107-7/8 | Y. P. | 12' |
| | | | 10 | 64 | PLANKING | 1 x 6 x 89-1/2 T.G. | Y. P. | 239' |
| | | | | 512 | NAILS | # 8 | T.G. | 3-3/4'# |
| | | | | 92 | NAILS | #16 | | 2# |
| AM'T. TOT. MAT'L. FOR BLOCKING | | END | 11 | 2 | HEADER | 2 x 4 x 102 | Y. P. | 12' |
| 16 | 6 x 8 x 18 | | 12 | 2 | BRACE | 2 x 8 x 58-3/4 | Y. P. | 14' |
| 6 | 3 x 5 x 48 | | 13 | 2 | BRACE | 2 x 8 x 56 | Y. P. | 13' |
| 2 | BANDIRON 1-1/4 x 49" | | 14 | 38 | PLANKING | 1 x 6 x 83-1/2 T.G. | Y. P. | 133' |
| 24 | #60 NAILS | | 15 | 2 | BRACE | 2 x 8 x 120-1/4 | Y. P. | 54' |
| 100 | #40 NAILS | | 16 | 4 | STUD | 2 x 8 x 80-1/4 | Y. P. | 18' |
| 280 | #8 NAILS | | 17 | 2 | HEADER | 2 x 2 x 91-1/2 | Y. P. | 6' |
| WEIGHT | | TOP | 48 | 16 | NAILS | #16 | | 1# |
| NET | 24,500# | | 18 | 19 | PLANKING | 1 x 6 x 175 T.G. | Y. P. | 139' |
| TARE | 3,600# | | 19 | 7 | BRACE | 2 x 8 x 102 | Y. P. | 80' |
| GROSS | 28,100# | | 20 | 3 | BRACE | 2 x 8 x 94-3/4 | Y. P. | 32' |
| OVERALL DIMENSIONS | | | 266 | 24 | NAILS | #8 | | 2# |
| HEIGHT | 92-1/4" | | 24 | | NAILS | #16 | | 1/2'# |
| WIDTH | 103-1/2" | | | | | | | |
| LENGTH | 175" | | | | | | | |
| Cubic Ft. | 969 | | | | | | | |

RA PD 17253

Figure 134—Shipping Crate Specifications

STORAGE AND SHIPMENT

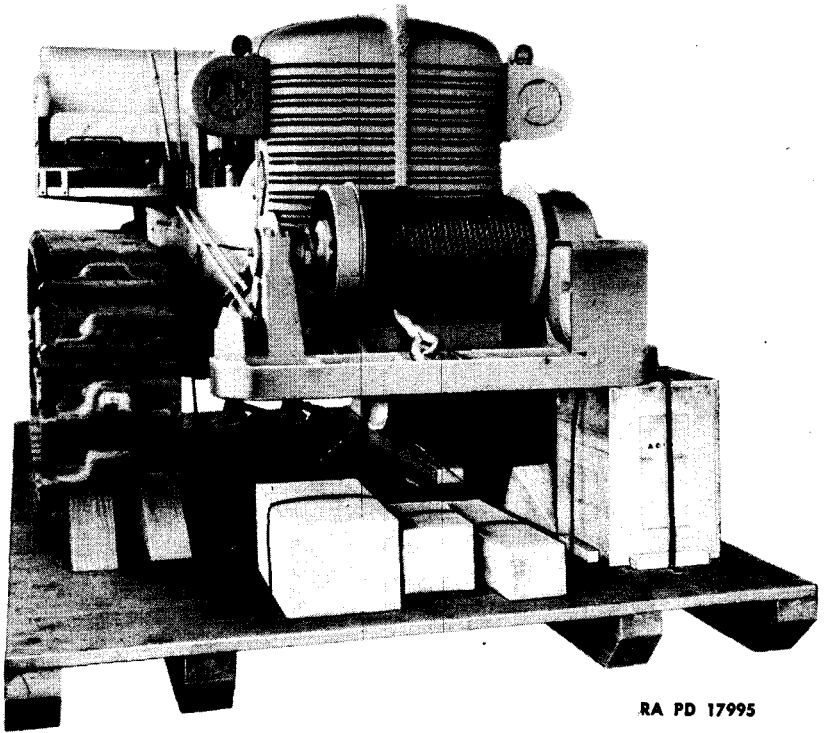

RA PD 17995

Figure 135—Tractor Blocked to Crate Floor—Front View

and nail ends to crate floor. Bore a $\frac{1}{2}$ -inch hole in crate floor and install a long $\frac{1}{2}$ -inch bolt through a hole in drawbar plate and through the hole bored in floor. The banding iron in front and bolt in rear is to keep tractor from bouncing on spring.

(2) Fasten pintles and exhaust tail pipe to floor of crate with nails and banding iron. Place lubricating equipment, precleaners, and tools in suitable boxes and fasten boxes to floor with blocks around boxes and banding iron to hold them to floor.

(3) Disconnect battery cables, put gear shift lever in lowest forward or reverse position and set tractor brakes. Then nail sides, and ends of crate to crate floor, and install top of crate.

132. LOADING.

a. If tractor is to be shipped by rail, it may be crated and hoisted on flat car. If this is done, the crate should have blocks nailed to floor of flat car on all four sides. Nail blocks well with 40-penny nails. If it is shipped uncrated, it should be fastened to floor of flat car or box

HEAVY TRACTOR M1

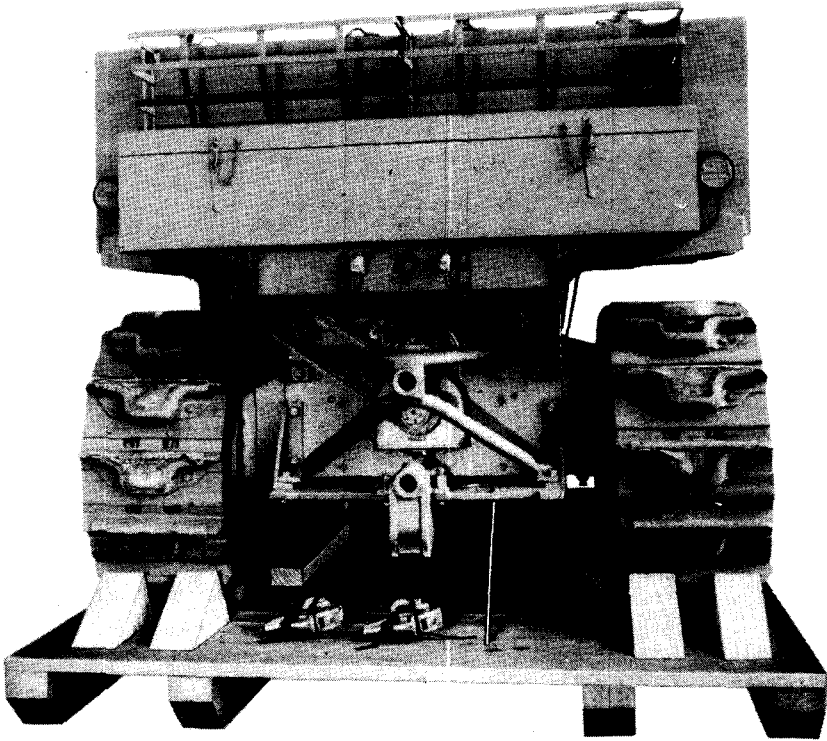

RA PD 17460

Figure 136—Tractor Blocked to Crate Floor—Rear View

car the same as it is fastened to crate floor, with the exception that the accessories will be left on tractor. Tools and equipment not carried in tool boxes should be put in one large box and box fastened to floor of car. If a flat car is used, the box should be covered with waterproof paper.

STORAGE AND SHIPMENT

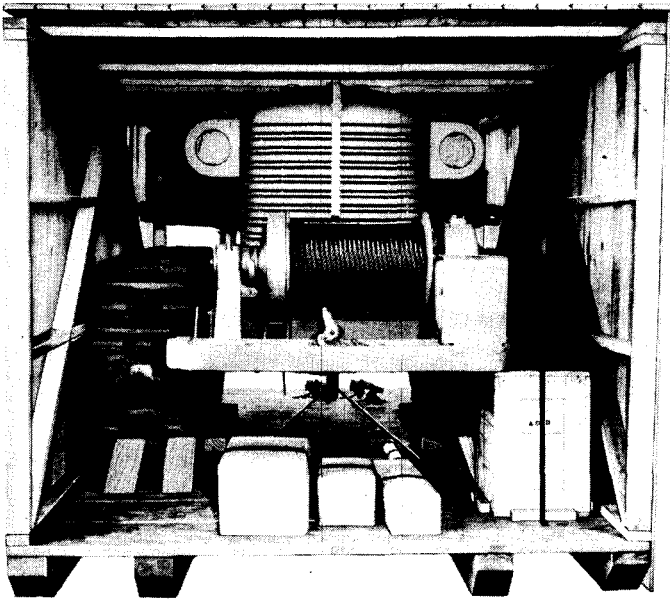

RA PD 17981

Figure 137—Tractor in Crate—Front View

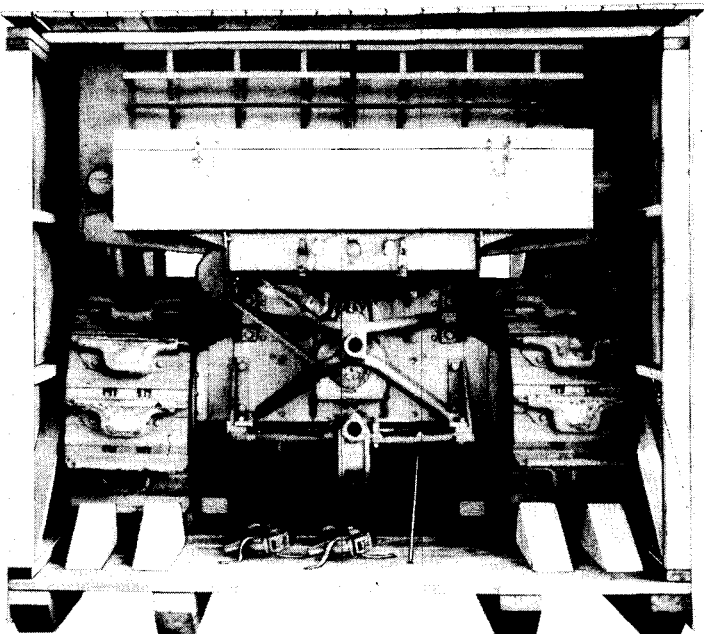

RA PD:17980

Figure 138—Tractor in Crate—Rear View

HEAVY TRACTOR M1

Section XXV

COLD WEATHER LUBRICATION AND SERVICE

| | Paragraph |
|---|-----------|
| General | 133 |
| Fuels for low temperature | 134 |
| Preparation and lubrication for continuous operation below 0 F. . . | 135 |
| Protection of cooling system | 136 |
| Mechanical condition of vehicle | 137 |
| Cold weather accessories | 138 |

133. GENERAL.

a. Operation of automotive equipment at subzero temperatures presents problems that demand special precautions and careful extra servicing if poor performance and possible total functional failure is to be avoided.

b. Extreme care must be exercised whenever a vehicle or parts are moved from a warm place into subzero temperatures as any moisture on surfaces will freeze there.

134. FUELS FOR LOW TEMPERATURE.

a. Many fuels suitable for Diesel engines operated in warm weather contain waxes that congeal at temperatures below 0 F. Congealed wax clogs fuel strainers and prevents fuel flow to the pump. Fuels for subzero operation are free from these materials. Therefore, Diesel fuel (U. S. Army Specification 2-102) will be used at low temperatures.

b. If emergency demands procurement of commercial fuel extreme care will be taken, if practicable, to see that the cloud point is 10 degrees lower than the lowest atmospheric temperature anticipated. Otherwise the fuel will not flow to the injectors in quantities sufficient for engine operation.

c. Water in Diesel fuel will freeze and stop fuel flow in the fuel pump. The following precautions should be taken to avoid formation of ice:

(1) Keep tank full as possible. The more fuel there is in the tank the less volume of air from which moisture can be condensed.

(2) Be sure that all containers are thoroughly clean, dry, and free from rust before storing fuel in them.

(3) If possible, after filling or moving a container, allow the fuel to settle 16 hours before filling vehicle tank with it.

(4) Keep all closures on containers tight to prevent snow, frost, or other foreign matter entering.

COLD WEATHER LUBRICATION AND SERVICE

135. PREPARATION AND LUBRICATION FOR CONTINUOUS OPERATION BELOW 0 F.

a. Lubrication of this vehicle at temperatures above 0 F is covered in section IV. The instructions contained in this section are to be followed only when temperatures below 0 F prevail.

b. Subzero temperatures affect both metals and lubricants. Therefore, special attention must be given to lubrication and servicing of equipment when such temperatures are encountered.

c. Shrouds and heaters are supplied and no oil dilution is necessary. For short shut down periods vehicle should be parked in a sheltered spot out of the wind if possible. If no shelter is available it will be helpful to park so that the vehicle is not facing the wind. For long periods of shut down as in bivouac, park vehicle in as sheltered a place as possible.

d. Starting in subzero weather is described in paragraph 12.

e. **Transmission and Gear Cases.** LUBRICANT, gear, universal, SAE 80, shall be used for temperatures above -20 F. Below -20 F LUBRICANT, gear, universal, SAE 80, diluted with the Diesel fuel in the proportion of one part fuel to six parts of lubricant shall be used.

f. Other lubrication points as track support rollers, are lubricated with LUBRICANT, gear, universal, SAE 80, above 0 F; no special attention is required.

(1) Universal and slip joints. Lubricate with GREASE, general purpose, No. 00.

(2) STEERING CLUTCH AND CLUTCH THROW-OUT BEARING. Lubricate with GREASE, general purpose, No. 00. Under conditions of 0 F and below it may be necessary to service these bearings more frequently than for normal operation.

(3) All other places requiring, GREASE, general purpose, shall be lubricated with OIL, lubricating, engine, SAE 30. CAUTION: When temperatures below 0 F are no longer anticipated the above bearings must be lubricated immediately with GREASE, general purpose, proper seasonal grade.

136. PROTECTION OF COOLING SYSTEM.

a. ETHYLENE GLYCOL (Prestone) is prescribed for use as an antifreeze solution in vehicle radiators. If ethylene glycol is not available, other materials may be used. The following table gives three permissible materials and the quantity required to protect the cooling system of this vehicle.

HEAVY TRACTOR M1

| Freezing Point | Pints, Ethylene Glycol (Prestone) | Pints, *G.P.A. Radiator Glycerine | Pints Denatured Alcohol |
|----------------|-----------------------------------|-----------------------------------|-------------------------|
| 10 F | 19½ | 29 | 24½ |
| 0 F | 24½ | 34 | 29 |
| -10 F | 29 | 34 | 34 |
| -20 F | 34 | 39 | 39 |
| -30 F | 39 | 49 | 49 |
| -40 F | 44 | — | 53½ |
| -50 F | 44 | — | 58½ |
| -60 F | 49 | — | 63½ |
| -70 F | 49 | — | — |

*G.P.A. denotes Glycerine Producers Association.

b. Do not use alcohol if the other materials are available for the temperatures indicated. Denatured alcohol boils at 173 F.

CAUTION: Do not mix antifreeze solutions.

c. The following precautions should be taken before installing the antifreeze solution.

(1) Thoroughly flush the cooling system. The radiator and the cylinder block should be flushed out separately in order not to transfer any residue from one unit to the other.

(2) Check the system for leaks; tighten the hose connections and replace if necessary.

(3) Check thermostats.

(4) Use radiator covers to accelerate and maintain normal engine operating temperatures. These covers may be improvised locally.

(5) Check the fan belt for adjustment or weakness. Replace the belt if necessary. Do not use rubber fan belts at temperatures below -20 F. Use leather, fiber, or synthetic rubber fan belts.

137. MECHANICAL CONDITION OF VEHICLE.

a. Electrical System.

(1) **WIRING.** Check and clean all connections, especially the battery terminals. Care should be taken that no short circuits are present.

(2) **BATTERIES.**

(a) The efficiency of batteries decreases sharply with decreasing temperatures and becomes practically nil at -40 F. Do not try to start the engine with the battery when it has been chilled to temperatures below -30 F. See that the battery is always fully charged with the hydrometer reading between 1.275 and 1.300. A fully charged battery will not freeze at temperatures likely to be encountered even in arctic climates, but a fully discharged battery will freeze and rupture at 5 F.

(b) Do not add water to batteries when they have been exposed to subzero temperatures unless the battery is to be charged immediately afterward. If water is added and the battery is not put on charge, the

COLD WEATHER LUBRICATION AND SERVICE

layer of water will stay at the top and freeze before it gets a chance to mix with the acid.

(3) **LIGHTS.** Inspect the lights carefully. Check for short circuits and presence of moisture around sockets.

b. Engine.

(1) Keep engine in the best mechanical condition.

(2) Inspect the fuel pump and injectors frequently for wear.

(3) Water pump should have been serviced prior to the advent of cold weather.

(4) It is necessary to bypass the full flow engine oil filter.

(5) Only in extreme emergencies below 30 F may the fuel filters be removed if the flow of fuel to the filter is reduced to a point where engine operation is impaired.

(6) Remove and wash air cleaner screens in SOLVENT, dry-cleaning, and replace.

c. Chassis.

(1) Brake bands, particularly on new vehicles, have a tendency to bind when they are very cold. Always have a blowtorch handy to warm these parts if they bind prior to moving or attempting to move the vehicle. Parking the vehicle with the brake released will eliminate most of the binding. Precaution must be taken under these circumstances to block the tracks or otherwise prevent movement of the vehicle.

(2) Inspect the vehicle frequently. The shock resistance of metals or resistance against breaking is greatly reduced at extremely low temperatures. Operation of vehicles on hard frozen ground causes strain and jolting which may result in screws breaking or nuts jarring loose.

(3) Disconnect mile meter cable at drive end when operating vehicle at temperatures of -30 F and below. Cables often fail to work properly at these temperatures and sometimes break due to the excessive drag caused by cold oil.

138. COLD WEATHER ACCESSORIES.

a. Some cold weather accessories are included in the cold starting equipment supplied with the vehicle. Items listed below may be used to supplement this equipment for starting and operating at temperatures as low as -40 F.

HEAVY TRACTOR M1

- (1) Insulated battery box with hot water coil in bottom.
- (2) Auxiliary battery warming gasoline burning heater.
- (3) Insulated battery box with hot air ducts in each compartment.
- (4) Foot warmer heater or cab heater.
- (5) Shroud for engine compartment on entire vehicle.
- (6) Under chassis heater.
- (7) Radiator shutters and louver guards.
- (8) Special engine cooling thermostat.
- (9) Engine coolant heater.
- (10) Straps and hold-downs for cold weather equipment.
- (11) Special fuel pump.

Section XXV

REFERENCES

| | Paragraph |
|-----------------------------------|-----------|
| Standard nomenclature lists | 139 |
| Explanatory publications | 140 |

139. STANDARD NOMENCLATURE LISTS.

- a. Cleaning, preserving and lubricating materials, recoil fluids, special oils, and similar items of issue SNL K-1
- b. Tractor, heavy, M1 w/winch (Allis-Chalmers HD-10 W) (Diesel) SNL G-98

Current standard nomenclature lists are as tabulated here. An up-to-date list of SNL's is maintained in the "Ordnance Publications for Supply Index" OPSI

140. EXPLANATORY PUBLICATIONS.

- a. **Automotive Materiel.**
- b. Cleaning, preserving, lubricating, and welding materials and similar items issued by the Ordnance Department TM 9-850
- Military motor vehicles AR 850-15
- Motor transport FM 25-10
- Tractor, heavy M1 (Allis-Chalmers HD-10 W) (Winch, Gar Wood) TM 9-1787A to D
- c. **Diesels.**
- Diesel engines TF 9-159
- Diesel engines and fuels FS 10-37
- Engine of the Diesel tractor TF 9-171
- Power train of the Diesel tractor TF 9-172
- The electrical system of the Diesel tractor TF 9-169
- The fuel system of the Diesel tractor ... TF 9-170
- The track and suspension system of the Diesel tractor TF 9-173

HEAVY TRACTOR M1

d. Inspection and Maintenance.

- Echelon system of maintenance TM 10-525
- Fire prevention, safety precautions, accidents TM 10-360
- Motor transport inspection TM 10-545

e. Miscellaneous.

- Automotive electricity TM 10-580
- Diesel engines and fuels TM 10-575
- Electrical fundamentals TM 1-455
- First echelon of maintenance FS 10-53
- Inspection of motor vehicles FS 10-58
- List of publications for training, including
training film and film strips FM 21-6
- Lubrication FS 10-39
- Second echelon of maintenance FS 10-54
- The internal combustion engine TM 10-570
- The motor vehicle driver—first echelon main-
tenance TF 11-558

f. Shipment and Storage.

- Loading of mechanized and motorized army
equipment on open top railroad equip-
ment—Association of American Railroads
- Storage of motor vehicle equipment AR 850-18

INDEX

| A | Page No. | Page No. |
|--|----------|--|
| Accessories, cold weather | 245-246 | Assignment record 49 |
| Adjustment | | Automotive materiel, special |
| fan belt (cooling system) | 138 | precautions for 55 |
| master clutch | 199-202 | B |
| master clutch brake assembly | 203 | Batteries |
| sprocket hub bearings | 213-214 | description 147 |
| steering clutches | 205-207 | installation 151-152 |
| checking | 204-205 | maintenance 149-151 |
| track release mechanism | 215-217 | new, preparing for use 18 |
| tractor brakes | 209-211 | storage 234-236 |
| valve clearance | 72-73 | trouble shooting 147-149 |
| winch worm safety brake | 226-227 | Belts, fan (cooling system) 138 |
| Air brakes | | Blackout light and bulb (<i>See under</i> Service lights) |
| air compressor | | Brakes (<i>See specific names</i>) |
| air lines, inspection and repair . 192 | | C |
| dash-mounted air valve | | Camouflage |
| installation and removal . . . 191 | | paint as 51 |
| description 187 | | preserving 52 |
| drive belt adjustment 190-191 | | Capacities of engine components, data on 16 |
| installation 189-190 | | Care (and preservation) 49 |
| maintenance 187-189 | | transmission 24 |
| removal 189 | | Chart |
| steering lever controlled air | | operation of engine preheater . . . 21 |
| control valve | | use of gear shift levers 24 |
| installation 192 | | Chassis of vehicle, cold weather |
| removal 191-192 | | treatment 245 |
| maintenance 58 | | Chemicals, liquid, removal of . . . 53-54 |
| operation of 28 | | Cleaning |
| Air cleaner, lubrication 32 | | general 49 |
| Air compressor | | materiel affected by gas 53 |
| crankcase capacity 16 | | Climatic conditions, unfavorable, storage in 235 |
| storage treatment 234 | | Clutch brakes, steering 26 |
| (<i>See also</i> air compressor <i>under</i> Air brakes) | | Clutch hub and pilot bearing, lubri- cation 36 |
| Air heater | | Clutches (<i>See</i> Master clutch, Master clutch brake assembly, and <i>Steer-</i> ing clutches) |
| description 163-164 | | Cold weather lubrication and ser- vice 242-246 |
| burner unit | | cold weather accessories 245-246 |
| installation 165-166 | | continuous operation below 0 F. . . 243 |
| removal 164-165 | | cooling system, protection of . . 243-244 |
| operation 20 | | fuels for low temperature 242 |
| pump assembly | | general discussion of 242 |
| installation 166-169 | | mechanical condition of vehicle |
| removal 166 | | chassis 245 |
| switch installation and removal . 169 | | electrical system 244-245 |
| Air hose couplings, use of 28 | | engine 245 |
| Air lines, inspection and repair . . . 192 | | |
| Air pressure gage 185 | | |
| Air system (<i>See</i> Fuel and air system) | | |
| Ammeter | | |
| description 160-161 | | |
| installation and removal 161 | | |
| Antifreeze solutions 243-244 | | |

HEAVY TRACTOR M1

| C—Cont'd | | Page No. | | | Page No. |
|--|--------------|----------|--|---------|----------|
| Connections for air brake hoses | 28 | | shipping weight | 12 | |
| Controller (See under Electric brakes) | | | steering | 14 | |
| Controls | | | tracks | 14 | |
| use of | 27 | | winch | 14 | |
| (See also Operating instructions and controls) | | | Dead storage | | |
| Cooling system | | | placing vehicles in | 233-235 | |
| capacity | 16 | | air compressor | 234 | |
| description | 124 | | battery | 234 | |
| fan assembly | | | cooling system | 234 | |
| belts | 138 | | definition | 233 | |
| description | 134 | | engine | 233 | |
| installation | 136 | | exterior | 234 | |
| trouble shooting | 134-135 | | equipment | 235 | |
| hoses and pipes | 134 | | inspections | 235 | |
| maintenance | 57 | | openings | 234 | |
| protection of in cold weather | 243-244 | | periodic treatment of engine and vehicle | 235 | |
| radiator | | | rust removal | 235 | |
| description | 130 | | unfavorable climatic conditions | 235 | |
| maintenance | 131 | | valves and rocker arms | 234 | |
| trouble shooting | 130-131 | | removing vehicles from | 235-237 | |
| storage treatment | 234, 235-236 | | battery | 236 | |
| thermostat | | | cooling system | 235-236 | |
| description | 132 | | crankcase | 236 | |
| installation | 133-134 | | cylinders | 236 | |
| removal | 132-133 | | fuel tank | 236 | |
| trouble shooting | 132 | | inspection | 236-237 | |
| water manifold | | | lubrication | 236 | |
| description | 128 | | starting the engine | 237 | |
| installation | 130 | | valves | 236 | |
| removal | 129 | | Decontamination of materiel affected | | |
| water pump | | | by gas | 53-54 | |
| description | 124-125 | | Definition of dead storage | 233 | |
| installation | 126-128 | | Description | | |
| lubrication | 37 | | air cleaner | 121-122 | |
| removal | 125-126 | | cooling system | | |
| trouble shooting | 125-126 | | general | 124 | |
| Crating vehicle for shipment | 237-239 | | fan assembly | 134 | |
| Cylinders | | | radiator | 130 | |
| number of | 14, 67 | | thermostat | 132 | |
| storage treatment | 236 | | water manifold | 128 | |
| | | | water pump | 124 | |
| | | | electric and air brake control system | 187 | |
| | | | air compressor | 187 | |
| | | | electric brakes | 192-193 | |
| | | | electrical system | | |
| | | | air heater | 163-164 | |
| | | | ammeter | 160-161 | |
| | | | batteries | 147 | |
| | | | general | 147 | |
| | | | generator | 152 | |

D

| | |
|----------------------------|--------|
| Data, tabulated | |
| capacities | 16 |
| dimensions of vehicle | 12-13 |
| engine | 14, 67 |
| general | 12 |
| maximum drawbar horsepower | 12 |
| maximum drawbar pull | 12 |
| performance | 13-14 |
| power take-off | 16 |

INDEX

| D—Cont'd | Page No. | | Page No. |
|------------------------------|----------|---------------------------------|----------|
| Description—Cont'd | | Electric brakes | |
| electrical system—Cont'd | | controller | |
| generator voltage regulator | 156-157 | installation | 194-195 |
| hour meter | 161-162 | location | 192 |
| light switch | 169 | removal | 193-194 |
| panel light | 172 | load control unit | |
| service lights | 173 | installation | 197 |
| starting motor | 158 | location and use | 192-193 |
| engine | 8, 62-66 | removal | 195 |
| equipment | 8 | maintenance | 58 |
| exhaust manifold and muffler | 74 | operation | 28 |
| final drives | 212 | Electrical system and equipment | |
| first stage filter assembly | 94 | air heater | 163-169 |
| fuel pump | 106 | ammeter | 160-161 |
| fuel supply tank | 92 | batteries | 147-152 |
| general | 8 | cold weather treatment | 244-245 |
| governor | 73 | description | 147 |
| hour meter | 29 | generator | 152-156 |
| lubrication system | | generator voltage regulator | 156-158 |
| general | 139 | hour meter | 161-163 |
| oil cooler | 143 | light switch | 169-172 |
| oil filter | 141 | maintenance | 57 |
| oil pump | 139 | panel light | 172 |
| master clutch | 198 | service lights | 173-174 |
| master clutch brake assembly | 202 | starting motor | 158-160 |
| mile meter | 31 | wiring | 178-180 |
| precleaners | 121 | | |
| seat | 8 | (See under above names for de- | |
| second stage fuel filter | 96 | tailed information) | |
| steering | 8 | Engaging the winch | 27 |
| steering clutches | 204 | Engine | |
| track assembly | 215 | cold weather treatment | 245 |
| tractor and engine number | 8 | crankcase capacity | 16 |
| tractor brakes | 209 | data | 14, 67 |
| transmission | 24 | description | 8, 62-66 |
| truck frame assembly | 215 | exhaust manifold and muffler | 74-77 |
| track release mechanism | 215 | governor | 73-74 |
| track support rollers | 220 | installation in vehicle | 85-90 |
| truck wheels | 217-218 | maintenance | 57 |
| winch and power take-off | 8, 226 | removal from vehicle | 77-84 |
| Dimensions of vehicle | 12-13 | rocker arm assembly | 69-72 |
| Direction of rotation | 67 | starting instructions | |
| Disassembly | | temperature 40 F to 0 F | 20 |
| first stage filter assembly | 95-96 | temperature below 0 F | 21-23 |
| second stage fuel filter | 98-99 | when removing vehicle from | |
| Drive chain, lubrication | 37 | storage | 237 |
| | | stopping | 24 |
| | | storage | 233, 234 |
| | | trouble shooting | 67-69 |
| | | valve clearance | 72-73 |
| | | Equalizing injectors | 118-120 |

E

Electric and air brake control system
(See Electric brakes and Air
brakes)

INDEX

| G—Cont'd | Page No. | Page No. |
|---|--------------|--|
| Gage—Cont'd | | |
| temperature | | |
| description | 184 | in deep mud |
| installation | 184-185 | in deep snow |
| removal | 184 | in sandy terrain |
| Gas, materiel affected by | 53-55 | in water |
| cleaning | 53 | prestarting |
| decontamination | 53-54 | vehicle |
| protective measures | 53 | limited storage |
| special precautions for automotive materiel | 55 | new |
| Gear cases, lubrication for operation | | placing in dead storage |
| below 0 F | 244 | removing from dead storage |
| Gear shift levers, use of | 24-25 | Instruments, nonelectrical (See Gage) |
| chart | 24 | |
| Generator | | K |
| belt installation and removal | 156 | Knocks in engine, cause and remedy |
| checks for normal operation | 153-154 | |
| description and operation | 152 | L |
| installation | 154-156 | Levers, gear shift, use of |
| lubrication | 33, 37, 152 | Lighting system (See Light switch and Panel light) |
| removal | 154 | Lights (See specific names) |
| trouble shooting | 152-153 | Light switch |
| Generator voltage regulator | | description |
| description | 156-157 | installation |
| installation | 157-158 | operation |
| removal | 157 | removal |
| Governor | 73-74 | Limited storage (See limited under Storage and shipment) |
| Grease fittings, cleaning | 49 | Liquid chemicals, removal of |
| Guide, lubrication | 32, 34-36 | Load control unit (See under Electric brakes) |
| H | | Loading vehicle for shipment |
| Headlight and bulb (See under Service lights) | | "Log Book," use of |
| Hoses and pipes | 134 | Lubricating devices, painting |
| Hour meter | | Lubricating oil pressure gage |
| description | 28, 161-162 | installation |
| how to read | 29-30 | removal |
| installation | 163 | Lubrication (See also Lubrication system) |
| removal | 162-163 | air cleaner |
| I | | clutch hub and pilot bearing |
| Illustrations for supplementary lubrication | 34-36, 37-41 | cold weather (See Cold weather lubrication and service) |
| Injectors, fuel (See injectors under Fuel and air system) | | drive chain |
| Inspection(s) | | electrical system |
| air lines | 192 | generator |
| general | 42 | starting motor |
| operation | | final drive |
| after 50 hours of | 45 | fuel filters |
| after 100 hours of | 45 | guide |
| during | 43 | oil filter |
| | | power take-off |
| | | reports and records |
| | | starter |

INDEX

| O—Cont'd | Page No. | Page No. |
|---|----------|----------|
| Operating instructions and controls | | |
| —Cont'd | | |
| transmission | 24-25 | |
| use of: | | |
| master clutch | 24 | |
| trailer brakes | 27-28 | |
| winch and controls | 27 | |
| Operation | | |
| air brakes | 28 | |
| air heater | 20 | |
| electric brakes | 28 | |
| engine preheater | 21 | |
| fuel injectors | 109-110 | |
| inspections (See operation under Inspection(s)) | | |
| lubrication for below 0 F | 243 | |
| master clutch | 198 | |
| new vehicle | 18 | |
| P | | |
| Paint(-ing) | | |
| as camouflage | 51 | |
| preserving | 52 | |
| general | 50 | |
| lubricating devices | 52 | |
| metal surfaces | 51 | |
| preparing | 50-51 | |
| removing | 52 | |
| Panel light | | |
| bulb installation and removal | 172 | |
| description | 172 | |
| functioning | 29 | |
| Parking vehicle | 29 | |
| Performance of vehicle, data on | 13-14 | |
| Pintle drawbar assembly | 220-225 | |
| installation | 222-224 | |
| pintle bracket assembly | | |
| installation | 225 | |
| removal | 224-225 | |
| removal | 220-222 | |
| Pipes, inspection | 134 | |
| Power take-off | | |
| capacity | 16 | |
| data on | 16 | |
| engaging for bearing lubrication | 27 | |
| servicing | 33 | |
| (See also Winch and power take-off) | | |
| Precleaners | 121 | |
| Preheater, engine | 21 | |
| Prestarting inspection | 42-43 | |
| Prestone, use of in cooling system | 243-244 | |
| Preventive maintenance (See Inspection(s)) | | |
| Protective measures for materiel affected by gas | 53 | |
| R | | |
| Radiator (See under Cooling system) | | |
| Reading: | | |
| hour meter | 29-30 | |
| mile meter | 31 | |
| Rear coupling socket | 28 | |
| Reassembly: | | |
| first stage filter assembly | 96 | |
| second stage fuel filter | 100 | |
| Records | | |
| assignment and "Log Book" | 49 | |
| lubrication | 37 | |
| References for lubrication | 32 | |
| Repairing wires | 180 | |
| Reports (See Records) | | |
| Rocker arm assembly | 69-72 | |
| general | 69 | |
| installation | 70-72 | |
| removal | 69-70 | |
| Rotation, direction of | 67 | |
| Rust removal from vehicle in storage | 235 | |
| S | | |
| Seat, description | 8 | |
| Second stage fuel filter (See under Fuel filters) | | |
| Sediment sumps | | |
| installation | 93 | |
| removal | 92-93 | |
| Serial number of vehicle | 8 | |
| Service lights | | |
| blackout light and bulb | | |
| installation | 176 | |
| removal | 174-175 | |
| description | 173 | |
| headlight and bulb | | |
| installation | 174 | |
| removal | 173-174 | |
| rear lamp assembly | | |
| installation | 177 | |
| removal | 176 | |
| stop light switch | 178 | |
| Shipment (See Storage and shipment) | | |
| Shipping weight | 12 | |
| Short circuit | 180 | |
| Speeds and drawbar pull | 13-14 | |
| Sprocket hub bearing adjustment | 213-214 | |

INDEX

| V | Page No. | Page No. |
|--|----------|----------|
| Valve clearance | | |
| adjustment | 72-73 | |
| general discussion of | 72 | |
| Valves (and rocker arms), storage | | |
| treatment | 234, 236 | |
| Vibration of engine, excessive, cause | | |
| and remedy | 67 | |
| W | | |
| Washing: | | |
| master clutch | 202 | |
| steering clutches | 207 | |
| Water manifold (<i>See under</i> Cooling system) | | |
| Water pump (<i>See under</i> Cooling system) | | |
| Weight | | |
| engine | 67 | |
| shipping | 12 | |
| Wheels, truck (<i>See</i> truck wheels <i>under</i> Truck frame assembly) | | |
| Winch (<i>See also</i> Winch and power take-off) | | |
| data | | 16 |
| description | | 8 |
| engaging | | 27 |
| lubrication | | 37 |
| maintenance | | 58 |
| use of | | 27 |
| Winch and power take-off | | |
| description | | 226 |
| maintenance | | 226-229 |
| cable | | |
| installation | | 229 |
| removal | | 227-229 |
| winch worm safety brake | | |
| adjustment | | 226-227 |
| Winch gear housing capacity | | 16 |
| Winch jaw clutch, lubrication | | 37 |
| Winch worm safety brake adjustment | | 226-227 |
| Wiring | | 178-180 |

[A. G. 062.11 (10-23-42)
 O. O. 461/26402 O. O. (12-3-42)
 TT GRA WAO 15 Dec. 5, 1836Z]

BY ORDER OF THE SECRETARY OF WAR:

G. C. MARSHALL,
Chief of Staff.

OFFICIAL:

J. A. ULIO,
*Major General,
 The Adjutant General.*

DISTRIBUTION:

IB4(3), 6(2); IR4 and 6(3); R9(2); IBn4 and 6(3), 9(1);
 IC4 and 6(6), 9(4) (For explanation of symbols, see FM 21-6)

THE ARMY **BY**
WASHINGTON, D.C.
 257